

NetSure 531 AC1 Power Supply System

User Manual

Version	V1.2
Revision date	December 30, 2017
BOM	31013070

Vertiv Tech provides customers with technical support. Users may contact the nearest Vertiv local sales office or service center.

Copyright © 2017 by Vertiv Tech Co., Ltd.

All rights reserved. The contents in this document are subject to change without notice.

Vertiv Tech Co., Ltd.

Address: Block B2, Nanshan I Park, No.1001 Xueyuan Road, Nanshan District, Shenzhen, 518055, P.R.China

Homepage: www.vertivco.com

E-mail: overseas.support@vertivco.com

Safety Precautions

To reduce the chance of accident, please read the safety precautions very carefully before operation. The "Caution, Note, Warning, Danger" in this book and on the product do not represent all the safety points to be observed, and are only supplement to various safety points. Therefore, the installation and operation personnel must receive strict training and master the correct operations and all the safety points before operation.

When operating Vertiv products, the operation personnel must observe the safety rules in the industry, the general safety points and special safety instructions specified in this book.

Electrical Safety

I. Hazardous voltage



Some components of the power supply system carry hazardous voltage in operation. Direct contact or indirect contact through moist objects with these components will result in fatal injury.

Observe safety rules in the industry when installing the power supply system. The installation personnel must be licensed to operate high voltage and AC power.

In operation, the installation personnel are not allowed to wear conductive objects, such as watches, bracelets, bangles and rings.

When you spot the cabinet with water or moisture, turn off the power immediately. In moist environment, precautions must be taken to keep moisture out of the power supply system.

"Prohibit" warning label must be attached to the switches and buttons that are not permitted to operate during installation.



High voltage operation may cause fire and electric shock. The connection and wiring of AC cables must be in compliance with the local rules and regulations. Only those who are licensed to operate high voltage and AC power can perform high voltage operations.

II. Tools



In high voltage and AC operation, specialized tools must be used.

III. Thunderstorm



Never operate on high voltage, AC, iron tower or mast in the thunderstorm.

In thunderstorms, a strong electromagnetic field will be generated in the air. Therefore the equipment should be well earthed in time to avoid damage by lightning strikes.

IV. ESD



The static electricity generated by the human body will damage the static sensitive elements on PCBs, such as large-scale ICs. Before touching any plug-in board, PCB or IC chip, you should wear the ESD wrist strap to prevent body static from damaging the sensitive components. The other end of the ESD wrist strap must be well earthed.

V. Short circuit



During operation, never short the positive and negative poles of the DC distribution unit of the power supply system or the non-grounding pole and the earth. The power supply system is a constant-voltage DC power device, short circuit will result in equipment burning and endanger human safety.

Check the polarity of the cable and connection terminal when performing DC live operations.

As the operation space in the DC distribution unit is very tight, please carefully select the operation space.

Never wear a watch, bracelet, bangle, ring, or other conductive objects during operation.

Use insulated tools.

In live operation, keep the arm, wrist and hand tense, so that when the tool in operation slips, the movement of the human body and tool is reduced to a minimum.

Battery



Before any operation on battery, read carefully the safety precautions for battery transportation and the correct battery connection method.



If the power supply system does not connect with AC power for a long time, to prevent battery overdischarge, users should cut batteries off from the power supply system thoroughly, for example, pulling out battery fuses or switching off battery MCBs. Before putting the power supply system into operation, insert all the battery fuses or switch on all the battery MCBs.

Non-standard operation on the battery will cause danger. In operation, precautions should be taken to prevent battery short circuit and overflow of electrolyte. The overflow of electrolyte will erode the metal objects and PCBs, thus causing equipment damage and short circuit of PCBs.

Before any operation on battery, pay attention to the following points:

1. Remove the watch, bracelet, bangle, ring, and other metal objects on the wrist.
2. Use specialized insulated tools.
3. Use eye protection device, and take preventive measures.
4. Wear rubber gloves and apron to guard against electrolyte overflow.
5. In battery transportation, the electrode of the battery should always be kept facing upward. Never put the battery upside down or slanted.

BLVD

The power supply system has load low voltage disconnection (LLVD) function and battery low voltage disconnection (BLVD) function.

LLVD means when the mains fails and batteries supply power, the power supply system cuts the non-priority load off when the battery voltage drops down to 44V. In this way, the battery remaining capacity can sustain the priority load longer. The LLVD voltage is settable, refer to *4.7.2 Battery Settings* for setting method.

BLVD means that when the battery voltage drops down to 43.2V, the power supply system will cut off the battery automatically to avoid shortening the battery life owing to the over-discharge of the battery. The BLVD voltage is settable, refer to *LVD parameters in 4.7.2 Battery Setting* for setting method.

BLVD and LLVD function is enabled before delivery, which means that if power outage lasts for a long time or the power supply system fails, there might be LLVD and BLVD. Users should connect the non-priority loads to LLVD routes, and connect the priority loads to BLVD routes according to the importance of the loads. For vital loads, users can disable BLVD to ensure reliability of the power supply.

The method of disabling BLVD is:

1. Hardware disabling BLVD: unplug the signal cable from J427 terminal of controller, and tag the BLVD-disabled label. Refer to *2.4.2 Connecting Signal Cables* for the controller position and interface description.
2. Software disabling BLVD: set 'BLVD Enable' parameter through the controller to 'N'. Refer to *LVD Parameter in 4.7.2 Battery Setting* for the setting method.



The advantage of enabling BLVD is protecting the batteries from over-discharge when the battery voltage is too low. The disadvantage of enabling BLVD is that when the battery voltage drops down to a certain value, all the loads (including non-priority loads and priority loads) will be cut off due to battery disconnection.

The advantage of software disabling BLVD is prolonging the power supply of priority loads. The disadvantage is that software disabling cannot prevent unwanted power failure due to misoperation or power system failure.

The advantage of hardware disabling BLVD is preventing unwanted power failure due to misoperation or power system failure, and ensuring the continuity of vital loads' power supply.

Others

I. Safety



When replacing the power input fuse of the controller and the power distribution unit, you must use the fuse with same type.

II. Sharp object



When moving equipment by hand, wear protective gloves to avoid injury by sharp object.

III. Power cable



Please verify the cable labels before connection.

IV. Signal cables

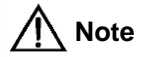

The signal cables should be routed at least 150mm away from power cables.

Contents

Chapter 1 Overview	1
1.1 Model Description	1
1.2 Composition & Configuration	1
1.3 Options	2
1.4 Features.....	3
Chapter 2 Installation Instruction	4
2.1 Safety Regulations.....	4
2.2 Preparation	4
2.3 Mechanical Installation.....	5
2.3.1 Fixing The Power Supply Cabinet	5
2.3.2 Installing Rectifiers	8
2.4 Electrical Installation	8
2.4.1 Connecting Power Cables	8
2.4.2 Connecting Signal Cables	11
Chapter 3 Testing.....	13
3.1 Installation Check And Startup.....	13
3.2 Basic Settings	14
3.3 Alarm Check And System Operation Status Check	14
3.4 Final Steps	15
Chapter 4 Use Of The Controller.....	16
4.1 Front Panel	16
4.2 Main LCD Pages.....	16
4.2.1 System Information Page	16
4.2.2 Enter Password Page.....	17
4.2.3 MAINMENU Page.....	17
4.2.4 STATUS Page	18
4.2.5 Settings Page	18
4.2.6 Maintenance Page.....	18
4.2.7 Energy Saving Page.....	19
4.2.8 Fast Settings Page	19
4.3 Querying System Main Information.....	19
4.4 Querying Rectifier Status	21
4.5 Querying Alarms	21
4.5.1 Querying Active Alarm.....	21
4.5.2 Querying History Alarm.....	23
4.6 Maintenance	23
4.7 Setting.....	24
4.7.1 Alarm Settings	24

4.7.2 Battery Settings	27
4.7.3 AC Settings.....	31
4.7.4 DC Settings	32
4.7.5 Rectifier Settings	32
4.7.6 System Settings.....	33
4.7.7 Communication Settings.....	34
4.8 Setting Energy Saving	34
4.9 Fast Settings.....	35
Chapter 5 Rectifier	36
5.1 Model Description	36
5.2 Structure Description	36
5.3 Functions & Features.....	37
5.4 Fault Protection.....	37
5.5 Technical Parameters	39
Chapter 6 Alarm Handling.....	41
6.1 Handling Alarms.....	41
6.2 Handling Rectifier Fault.....	42
6.3 Handling Controller Fault	44
Appendix 1 Technical Parameter	46
Appendix 2 Engineering Diagram.....	48
Appendix 3 Parameter Setting Of The Controller	49
Appendix 4 Menu Structure Of The Controller	53
Appendix 5 Schematic Diagram	55
Appendix 6 Wiring Diagram.....	56
Appendix 7 Glossary	59

Chapter 1 Overview

This chapter introduces model description, composition & configuration, and features of NetSure 501 AC1 power supply system (abbreviated as 'power supply system' hereinafter).

1.1 Model Description

Taking NetSure 501 AC1-Y1 as an example, the model description of the power supply system is given in Figure 1-1.

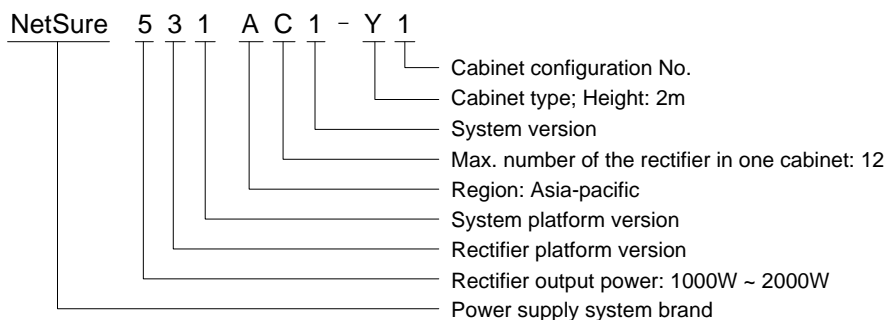

Figure 1-1 Model description

1.2 Composition & Configuration

NetSure 531 AC1 power supply system includes three models: NetSure 531 AC1-Y1, NetSure 531 AC1-Y6 and NetSure 531 AC1-W6. Select a appropriate configuration according to your requirement. NetSure 531 AC1-Y1 and NetSure 531 AC1-Y6 power supply systems are integrated, fixed-configuration cabinets with battery compartments; NetSure 531 AC1-W6 power supply system is a fixed-configuration cabinet without battery compartment.

The appearances of the NetSure 531 AC1 power supply system are shown in Figure 1-2, Figure 1-3 and Figure 1-4.

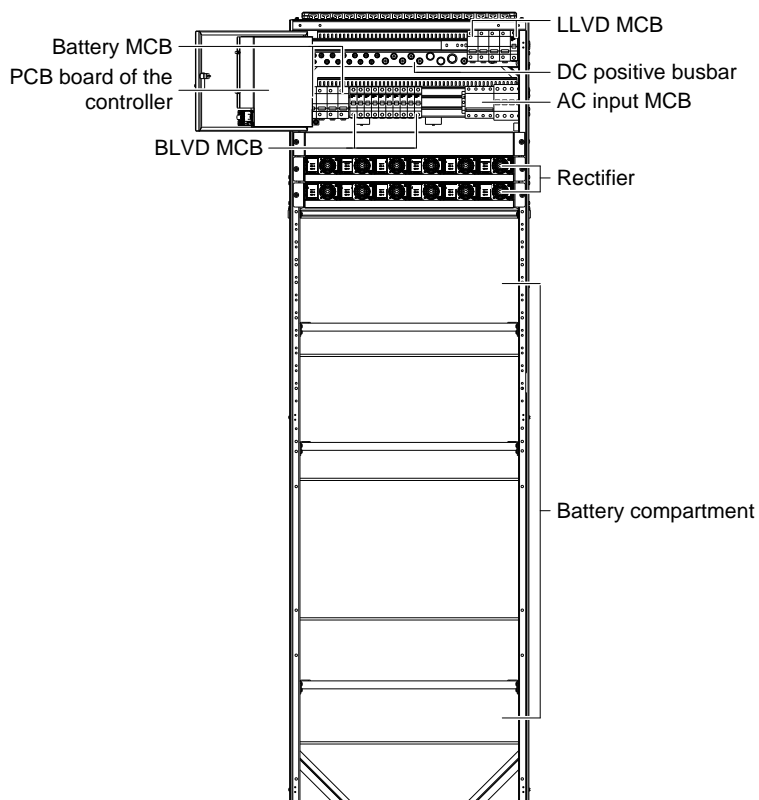

Figure 1-2 Appearance of NetSure 531 AC1-Y1 power supply system

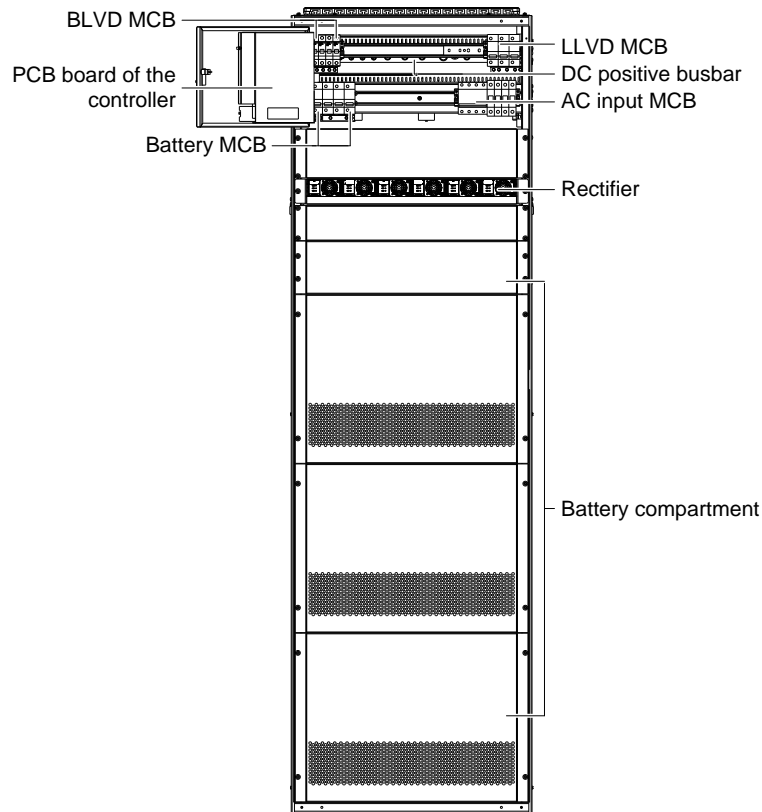

Figure 1-3 Appearance of NetSure 531 AC1-Y6 power supply system

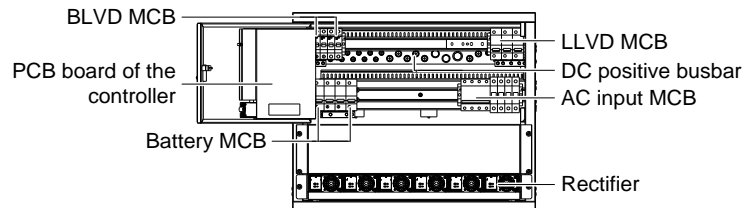

Figure 1-4 Appearance of NetSure 531 AC1-W6 power supply system

The configuration of the NetSure 531 AC1 power supply system is listed in Table 1-1.

Table 1-1 Configuration of the NetSure 531 AC1 power supply system

Item	Description	
	NetSure 531 AC1-Y4	NetSure 531 AC1-Y5
Rectifier	Model: R48-2000e3/R48-2000A3 Optional configuration: 2 pieces ~ 12 pieces Standard configuration: 12 pieces	Model: R48-2000e3/R48-2000A3 Optional configuration: 2 pieces ~ 6 pieces Standard configuration: 6 pieces
Controller	Model: M520S Standard configuration: 1 piece	Model: M520S Standard configuration: 1 piece
AC power distribution	AC input mode: 3P + N + PE/ 380V + SPD	AC input mode: 3P + N + PE/ 380V + SPD
DC power distribution	10 BLVD routes: 2 × 16A/1P, 8 × 10A/1P MCB 6 LLVD routes: 2 × 125A/1P, 2 × 80A/1P, 2 × 63A/1P MCB	4 BLVD routes: 2 × 16A/1P, 2 × 32A/1P MCB 3 LLVD routes: 3 × 100A/1P MCB
Battery routes	Battery MCBs: 4 × 100A/1P Max. battery configuration: 4 × 4 × (12V/165Ah) or 4 × 4 × (12V/100Ah)	Battery MCBs: 4 × 100A/1P Max. battery configuration: 4 × 4 × (12V/165Ah) or 4 × 4 × (12V/100Ah)
Optional parts	Two temperature sensors	Two temperature sensors

1.3 Options

The integrated power supply system that has battery compartments is defined as M+ cabinet. The power supply system that has no battery compartments is defined as S cabinet.

S cabinet may choose a battery cabinet as an option. The models and descriptions of the battery cabinet are listed in Table 1-2.

Table 1-2 Models and descriptions of the battery cabinet

Model	Layer	Battery capacity	Battery number
PS08-165C2Z	2	165Ah	8
PS12-165C3Z	3	165Ah	12
PS16-165C4Z	4	165Ah	16
PS20-100C5Z	5	100Ah	20

1.4 Features

- The rectifier uses the active Power Factor Compensation (PFC) technology, raising the power factor to 0.99
- The power supply system has wide AC input voltage range: 85Vac ~ 290Vac
- The rectifier uses soft switching technology, raising the efficiency to 94%
- The rectifier has ultra-low radiation. With advanced EMC design, the rectifier meets international standards such as CE and NEBS. Both the conducted and radiated interference reach Class A
- The rectifier safety design complies with CE standards, the R48-2000e3 rectifier also complies with UL and NEBS standards
- The rectifier is of High power density
- The rectifier is hot pluggable. It takes less than 1min to replace a rectifier
- The rectifier has two optional over-voltage protection methods: hardware protection and software protection. The latter one also has two optional modes: lock-out at the first over-voltage and lock-out at the second over-voltage
- The controller has perfect battery management function. The management functions include BLVD, temperature compensation, auto voltage regulation, stepless current limiting, battery capacity calculation and on-line battery test, etc
- The controller can save up to 200 pieces of historical alarm records, and 10 sets of battery test data records
- The controller is of network design. Providing multiple communication ports (such as RS232, modem and dry contacts), which enables flexible networking, remote monitoring and unmanning
- The power supply system has perfect lightning protection at both AC side and DC side
- The power supply system has complete fault protection and fault alarm functions

Chapter 2 Installation Instruction

This chapter introduces installation and cable connection. Before installation, please read through safety regulations, and then follow this instruction to carry out the installation step by step.

2.1 Safety Regulations

Certain components in this power system carry hazardous voltage and current. Always follow the instructions below:

1. Only the adequately trained personnel with satisfactory knowledge of the power system can carry out the installation. The most recent revision of these safety rules and local safety rules in force shall be adhered to during the installation.
2. All external circuits that are below 48V and connected to the power system must comply with the requirements of SELV as defined in IEC 60950.
3. Make sure that the power (mains and battery) to the system is cut off before any operations can be carried out within the system cabinet.
4. The power cabinets shall be kept locked and placed in a locked room. The key keeper should be the one responsible for the power system.
5. The wiring of the power distribution cables should be arranged carefully so that the cables are kept away from the maintenance personnel.

2.2 Preparation

Unpacking inspection

The equipment should be unpacked and inspected after it arrives at the installation site. The inspection shall be done by representatives of both the user and Vertiv Tech Co., Ltd.

To inspect the equipment, you should open the packing case, take out the packing list and check against the packing list that the equipment is correct and complete. Make sure that the equipment is delivered intact.

Cables

The cable should be selected in accordance with relevant industry standards.

It is recommended to use the RVVZ cables as AC cables. The cable should reach at least +70°C temperature durability. Select the AC cable CSA according to Table 2-1.

Table 2-1 AC cable CSA selection

Connector	Specifications	AC cable CSA
AC input MCB	1 × 63A/4P, four H-tube cable terminals	10mm ² ~ 35mm ²
AC input MCB	1 × 32A/4P, four H-tube cable terminals	6mm ² ~ 16mm ²
AC input MCB	1 × 100A/4P or 1 × 100A/2P, one or two H-tube cable terminals	16mm ² ~ 35mm ²
AC output terminals	UK35/2P, two H-tube cable terminals	25mm ² ~ 35mm ²
Note: With cable length shorter than 30m, the CSA calculation should be based on the current density of 2.5A/mm ² . The suggested CSA value is not smaller than 15mm ²		

The CSA of DC cable depends on the current flowing through the cable, the allowable voltage drop and load peak current. The recommended load peak current is 1/2 to 2/3 of MCB or fuse capacity.

Select the battery cable CSA according to Table 2-2. Select the load cable CSA according to Table 2-3.

Table 2-2 Battery cable CSA selection

Battery MCB rated current	Max. battery current	Min. cable CSA	Max. cable length (allowable voltage drop: 0.5V)
100A	100A	25mm ²	7m
125A	125A	25mm ²	6m

Note:

- The specs are applicable at ambient temperature of 25°C. If the temperature is too high, the CSA of the cable should be increased.
- The battery cable should reach at least 90°C heat durability. It is recommended to use double-insulated copper-core flame-retardant cable as battery cable

Table 2-3 Load cable CSA selection

Load route rated current	Max. output current	Min. cable CSA	Max. cable length (volt drop: 0.5V, with min. CSA)	Max. cable CSA	Max. cable length (volt drop: 0.5V, with max. CSA)
125A	63A	25mm ²	11m	50mm ²	22m
100A	50A	25mm ²	14m	50mm ²	28m
80A	40A	25mm ²	17m	50mm ²	34m
63A	32A	16mm ²	14m	25mm ²	22m
32A	16A	16mm ²	28m	25mm ²	44m
16A	10A	6mm ²	16m	16mm ²	42m
10A	5A	6mm ²	32m	16mm ²	84m

Note:

The specs are applicable at ambient temperature of 25°C. If the temperature is too high, the CSA of the cable should be increased

The CSA of the system earth cable should be the same as that of the largest power distribution cable and not less than 35mm². The earth terminal of the earth busbar is M10 bolt.

2.3 Mechanical Installation

2.3.1 Fixing The Power Supply Cabinet

Installation to the ground

M+ cabinet should be installed to the cement ground.

1. Mark the specific installation position of the cabinet

Determine the installation position of the power cabinet in the equipment room according to Figure 2-1. The cabinet can be installed against the wall.

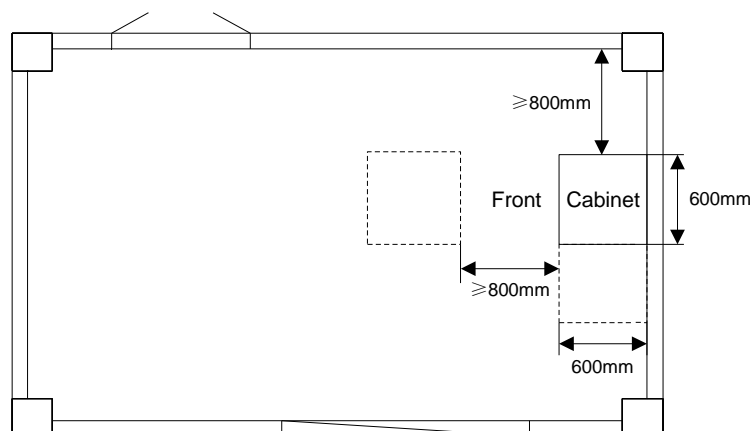

Figure 2-1 Equipment room layout

Note

If the system fixed on a battery cabinet is installed against the wall, the installation sequence should be as follows:

1. Connecting cables;
2. Placing the battery cabinet to the installation position, and fixing the battery cabinet;
3. Installing batteries.

2. Install expansion pipe

According to Figure 2-2, mark the installation points on the ground. Use the electric drill (aiguille: $\Phi 14$) to dig holes (depth: 70mm) at the marked points. Clean the drilled hole of dust. Put the expansion pipe into the hole and knock it in.

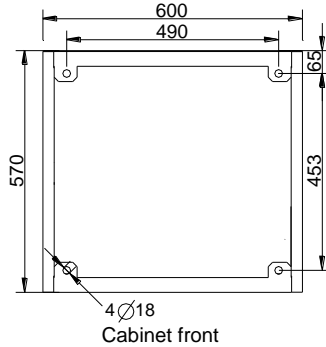

Figure 2-2 Installation dimensions (unit: mm)

3. Fix the cabinet

Move the cabinet to the installation position. Align the installation holes on the installation parts with those dug on the rack. Screw the bolts down.

After installation, the cabinet should stand firmly no matter how it is shaken.

Installation to the battery cabinet

S cabinet should be installed to the battery cabinet or to the wall.

The installation procedures are described as follows:

1. Use the installation assembly to fix the back side of the power supply system to the battery cabinet, as shown in Figure 2-3.

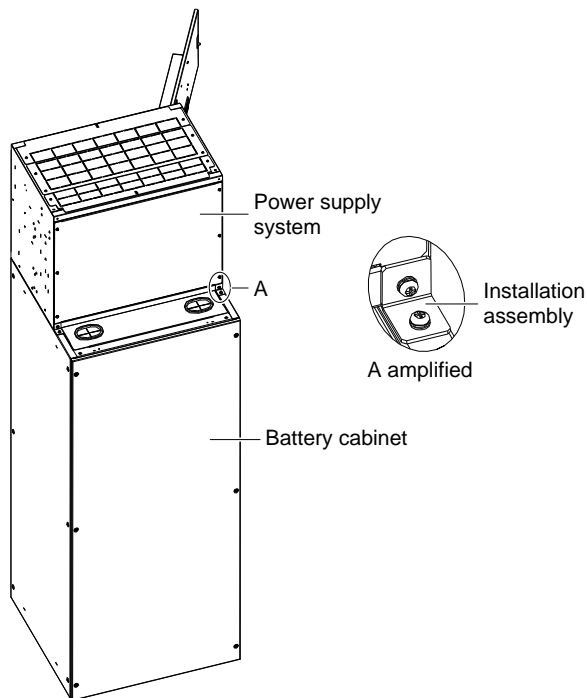

Figure 2-3 Installing the power supply system to the battery cabinet (back view)

2. Use the fixing bolts to fix the power supply system to the battery cabinet, as shown in Figure 2-4.

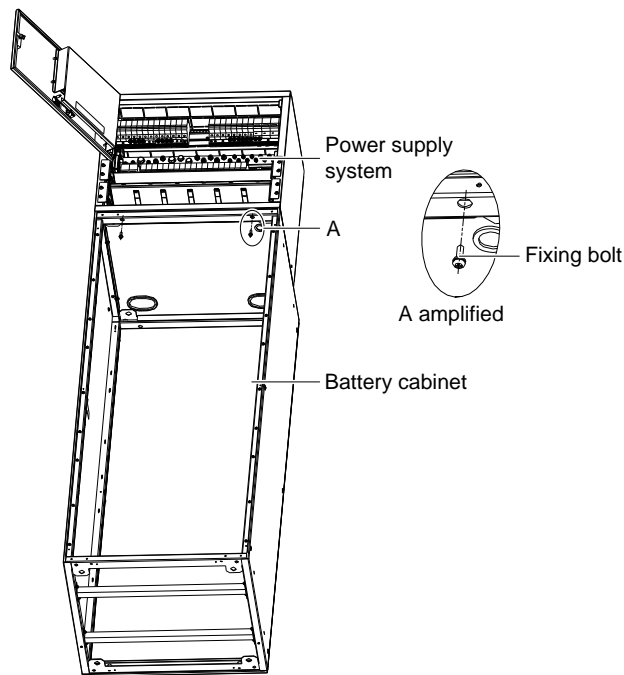

Figure 2-4 Installing the power supply system to the battery cabinet (front view)

Installation to the wall

The installation procedures are described as follows:

1. Mark the installation points on the wall. Use the electric drill (aiguille: $\Phi 10$) to dig holes (depth: 55mm) at the marked points. Clean the drilled hole of dust. Put the expansion pipe into the hole and knock it in.
2. Use bolts to fix the installation assembly to the power supply system. Use plain washers, spring washers and nuts to fix the power supply system to the wall, as shown in Figure 2-5 and Figure 2-6.

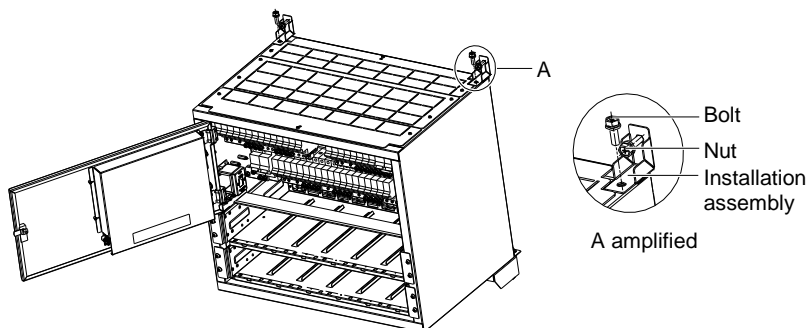

Figure 2-5 Installing the power supply system to the wall (a)

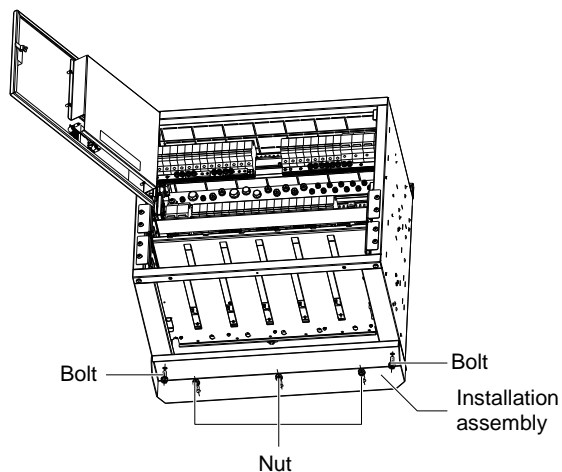

Figure 2-6 Installing the power supply system to the wall (b)

2.3.2 Installing Rectifiers

Note

1. In the non-full-configuration, install the dummy plates from left to right at the empty slots.
2. When installing the rectifier, hold the handle and push the rectifier to the slot gently, otherwise the slot may be damaged.

The procedures of installing rectifiers are as follows:

1. Loosen the fixing screw of the handle, pull the fixing screw of the handle by hand to pull out the handle.

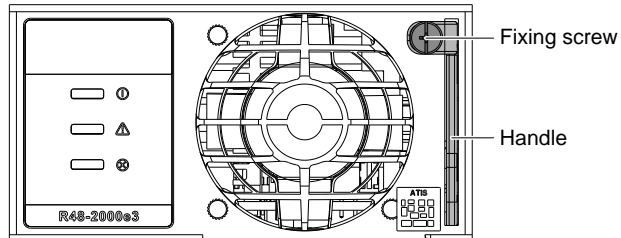

Figure 2-7 Handle of the rectifier

2. Put the rectifier onto the position shown in Figure 2-4. Push the rectifier completely into the cabinet.
3. Push the handle into the front panel to lock the rectifier to the cabinet. Fix the fixing screw of the handle with a cross head screwdriver. The mounted rectifiers are shown in Figure 2-8.

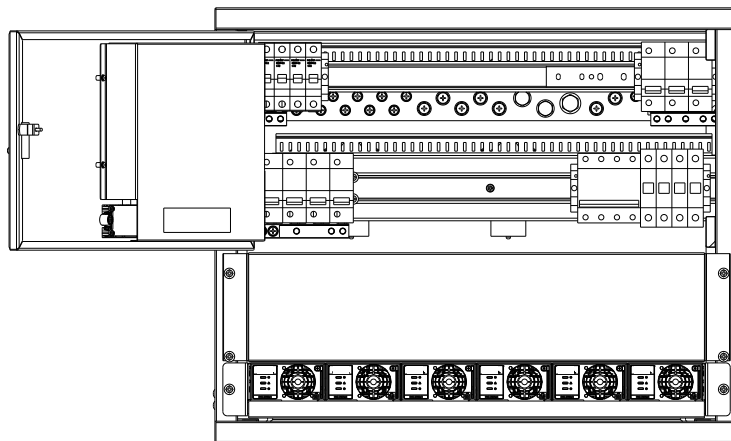

Figure 2-8 Mounted rectifiers

2.4 Electrical Installation

2.4.1 Connecting Power Cables

Danger

1. Switch off all MCBs before the electrical connection.
2. Only the qualified personnel shall do the power cable connection.

Connecting earth cable

Connect one end of the earth cable to the earth busbar of the machine room, and the other end to the earth terminal of the power supply system. Feed the cables into the cabinet from the top. The position of the earth terminal is shown in Figure 2-9.

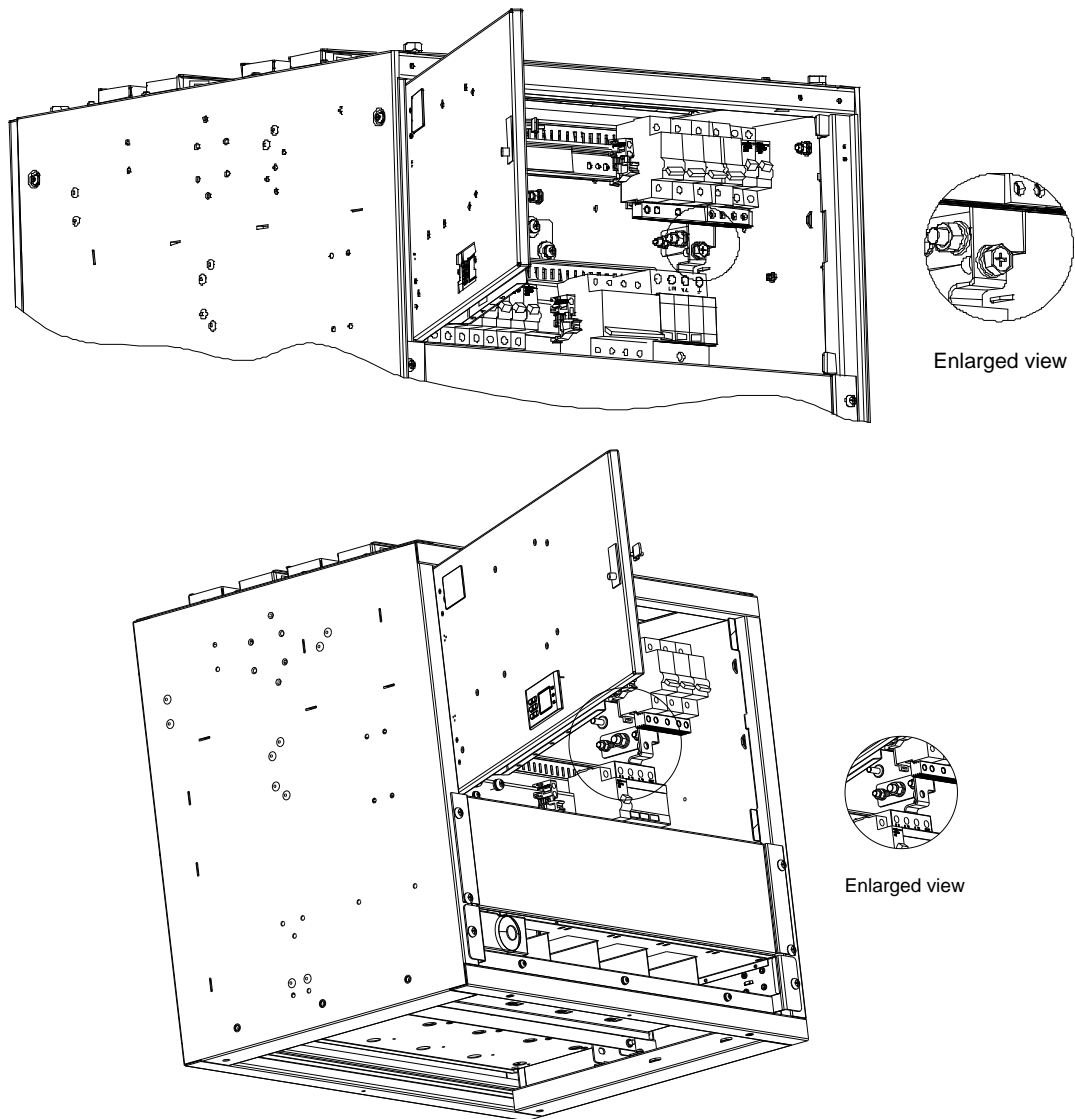

Figure 2-9 Earth terminal position

Connecting AC cables

Connect the AC input cables to the AC input MCB or terminals in the AC input areas, as shown in Figure 2-10.

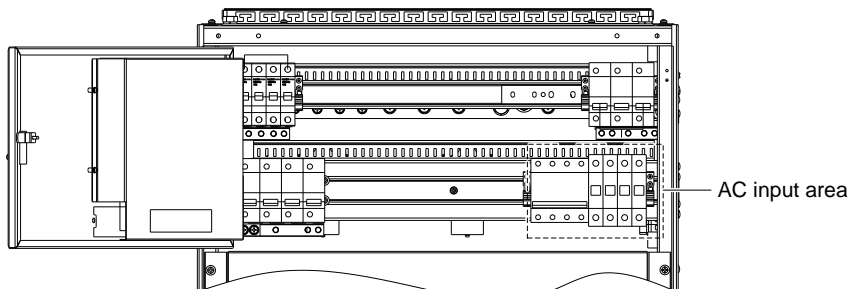

Figure 2-10 AC input areas

Connecting load cables

Connect the negative load cable to the upper terminal of load MCBs (LLVD MCBs and BLVD MCBs). Connect the positive load cable to the DC positive busbar, as shown in Figure 2-11.

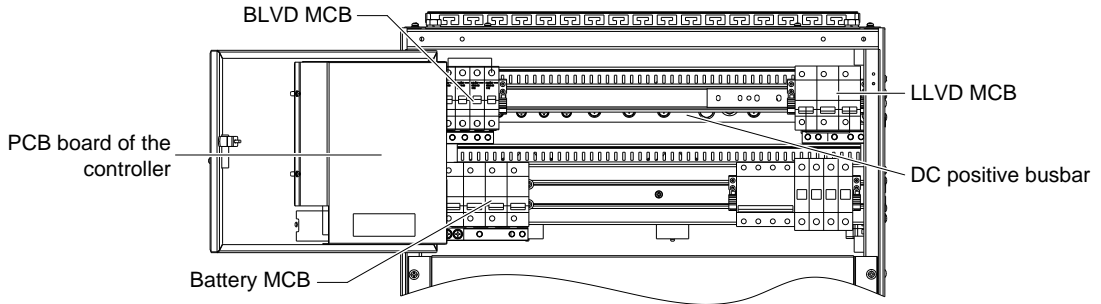

Figure 2-11 Connection terminals

Connecting battery cables

Note

1. The batteries may have dangerous current. Before connecting battery cables, make sure that the battery fuses at the system side (shown in Figure 2-8) and the battery MCBs at the battery side are switched off. If there are no battery MCBs at the battery side, users should disconnect any one of the connectors between battery cells to avoid live state of the power supply system after installation.
2. Be careful not to reversely connect the battery. Otherwise, both the battery and the power supply system will be damaged!
3. When users install batteries, batteries in the lowest layer should be installed firstly, and batteries in the most upper layer should be installed lastly. When users remove batteries, the batteries should be removed in a reverse order, to prevent turnover of the cabinet.

1. Cable connection of M+ cabinet

The battery cables are connected at the factory. When connecting batteries, pull out the heat shrinkable tube wrapped around the cable terminals and connect the battery cables to the positive and negative terminals of the batteries.

2. Cable connection of S cabinet

The battery cables of S cabinet are accessories. The cable connection procedures are as follows:

- 1) Connect one end of the negative battery cable to the upper terminal of the battery MCB. According to *Appendix 6 Wiring Diagram*, connect one end of the positive battery cable to the positive busbar. The connection terminals are shown in Figure 2-11.
- 2) Route the battery cables through top cover of the power supply system and battery cable entry holes of the battery cabinet. Bind the cables beside the battery. Wrap all the bare parts of the cable terminals with insulating tape. Do not connect the cables to the battery until the DC distribution unit is to be tested. The positions of the battery cable entry holes are shown in Figure 2-12.

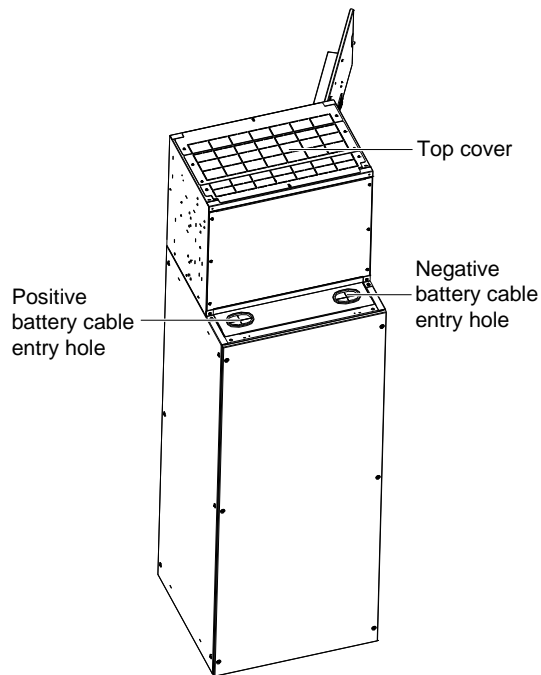

Figure 2-12 Battery cable entry hole

2.4.2 Connecting Signal Cables

All the signal cables are connected to the PCB board of the controller. The position of the PCB board is shown in Figure 2-13.

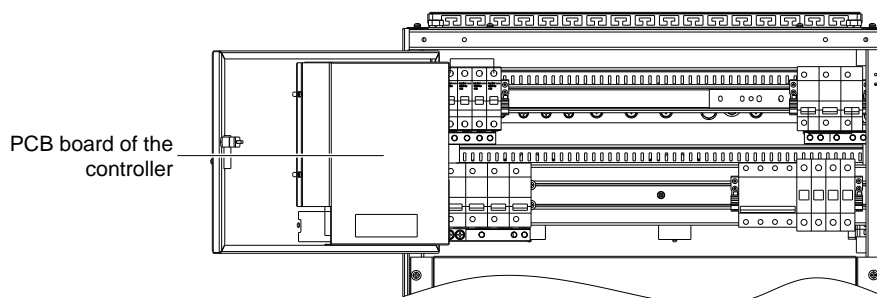

Figure 2-13 PCB board of the controller

The interfaces are shown in Figure 2-14.

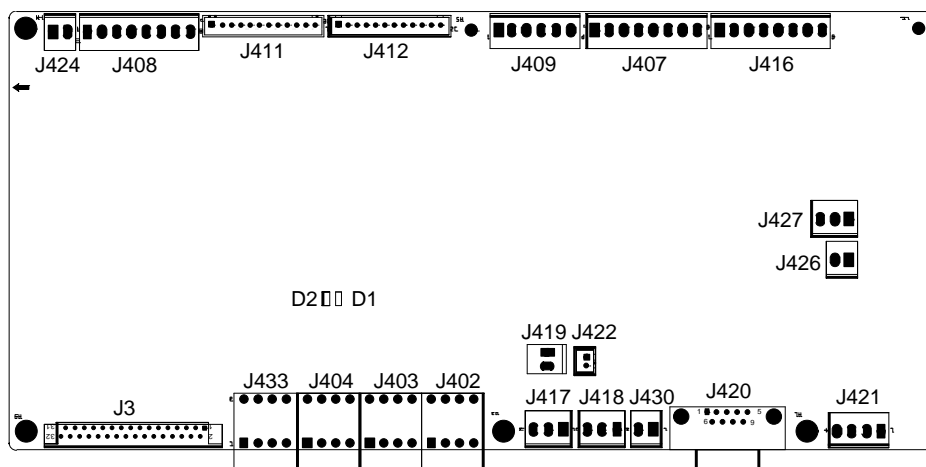

Figure 2-14 Interfaces of the controller

The functions of the interfaces are given in Table 2-4. Connect signal cables according to Table 2-4.

Table 2-4 Descriptions of interface and cable connection

Terminal	Definition	Connection description
J402 ~ J404	Eight dry contact outputs	Connected to signal cables
J433	Four wet contact inputs	Connected to signal cables
J417	Battery temperature sensor terminal	Connected to battery temperature sensor
J418	Ambient temperature sensor terminal	Connected to ambient temperature sensor
J420	RS232 port	Connected to a modem or an upstream host
J426	LLVD normally-closed contact	The port has been connected before delivery. Switching on this port gets the LLVD contactor controlled by the controller. For control condition, refer to 4.7.2 <i>Battery Settings</i>
J427	BLVD normally-closed contact	The port has been connected before delivery. Switching on this port gets the BLVD contactor controlled by the controller. For control condition, refer to 4.7.2 <i>Battery Settings</i>
J430	Providing 12V power to modem	Connected to the power cable of the modem

Connecting temperature sensor cable

The temperature sensor is an optional accessory. The operating voltage of its probe is 5V, the measurement range is -5°C ~ +100°C, the measurement precision is ± 2°C.

The installation procedures are described as follows:

1. Connect the three-core plug of the temperature sensor cable to the J417 or J418 terminal of the controller.
2. Put the temperature probe in the battery room where best represents the ambient temperature of the battery. Do not connect it to other heat-generating equipment. When the battery is outside the cabinet, the temperature probe cannot be placed in the cabinet.

Connecting dry contacts

The controller provides three pairs of dry contacts, which are J402 ~ J404 dry contacts shown in Figure 2-14.

The connection method is as follows:

Peel one end of the signal cable and insert it into the J402 ~ J404 terminals. Fasten the connection by tightening the screw on the terminal.

The functions of J402 ~ J404 dry contacts are given in Table 2-5.

Table 2-5 Dry contact functions

Terminal	Function	Terminal	Function
J402_1 (DO1)	Mains failure	J403_1/ J404_1 (DO5)	LLVD
J402_2 (DO2)	DC over/ under-voltage	J403_2/ J404_2 (DO6)	Reserved
J402_1/ J403_1 (DO3)	Rectifier failure	J404_1 (DO7)	Reserved
J402_2/ J403_2 (DO4)	BLVD	J404_2 (DO8)	Reserved
Note: The above functions are default settings. You can change them through the controller			

Chapter 3 Testing

This chapter introduces procedures of testing. The corresponding safety rules shall be adhered to in the test.

3.1 Installation Check And Startup

Before the test, inform the chief manufacturer representative. Only the trained electrical engineer can maintain and operate this equipment. In operation, the installation personnel are not allowed to wear conductive objects such as watches, bracelets, bangles and rings.

During operation, parts of this equipment carry hazardous voltage. Misoperation can result in severe or fatal injuries and property damage. Before the test, check the equipment to ensure the proper earthing. Installation check must be done before testing. Then the batteries can be charged for the first time.

Make sure that the AC input MCBs, battery MCBs and load MCBs (LLVD MCBs and BLVD MCBs) are switched off. Make sure that all the devices are properly installed.

Check the following item one by one:

Installation check

Check item	OK	Comments
Check all the MCBs and cables. Are their models correct?	<input type="checkbox"/>	
Check the input and output cable connection, and system grounding	<input type="checkbox"/>	
Check if the number and connections of the batteries are correct. Check the polarity of the battery string with a voltmeter	<input type="checkbox"/>	
Check all the connections. Make sure that the connections are firmly and reliably	<input type="checkbox"/>	
Make sure all the communication cables and alarm cables are connected to the controller. Check that the temperature sensor, if any, has been installed	<input type="checkbox"/>	

Startup preparations

Check item	OK	Comments
Make sure that all the MCBs are switched off	<input type="checkbox"/>	
Measure the AC input voltage. Make sure the input voltage is within the allowable range	<input type="checkbox"/>	Umin=___V
Check that at least one shorting copper bar disconnects to the battery string before finishing the battery installation, to prevent short circuit	<input type="checkbox"/>	
Connect the disconnected batteries to the battery string circuit	<input type="checkbox"/>	
Measure with a voltmeter across the connection points of each battery and make sure that the polarity is right. For a lead-acid battery with 24 cells, the voltmeter should read 2.0 ~ 2.1V/cell or 48 ~ 51V/battery. If the voltage of certain cell is lower than 2.0V, that cell must be replaced	<input type="checkbox"/>	Umin=___V
Check with an ohmmeter that there is no short circuit between the positive & negative distribution busbars, or between the positive & negative battery poles (Note: Pull out all rectifiers before the check, and restore them after the check)	<input type="checkbox"/>	

Startup

Check item	OK	Comments
Switch on the system AC input MCB. The controller should display the correct voltage and current	<input type="checkbox"/>	
The green LED on the rectifier will be on and the fan will start running after a certain delay. The controller will show that the output voltage is 53.5V	<input type="checkbox"/>	
Check the system voltage and busbar polarity with a voltmeter. The voltage difference between the measured value and displayed value should be less than $\pm 0.3V$	<input type="checkbox"/>	
Start and stop each rectifier of the system by inserting and unplugging the rectifier. Check their output voltages of the rectifiers	<input type="checkbox"/>	

3.2 Basic Settings

When the power supply system is put into service for the first time, the parameters of controller must be set based on the actual system configuration, such as battery number, capacity, user's charge current limit and other functional requirements. Only after that can the controller display system operation information and control the output.

Enter the main menu → Settings (password: 1) → Battery Settings → Basic Setting. Set the 'Sys Mode' parameter to 'Manual'. Return to the Settings menu to set the parameters in relative submenus. For detailed controller parameter setting method, see 4.7 *Setting*.

Check item	OK	Comments
The system model has been set correctly in factory before delivery, check that the setting agrees with the actual system (48V/SET)		
The battery string number set at the controller should be the same as the number actually connected. (Default: 4)		
Set the battery capacity according to the total capacity of all the battery connected to the system. Default: 300Ah		
Configure the temperature coefficient according to the battery manufacturer's requirement. Setting range: 0 ~ 500mV/°C. By default: 72mV/°C. (if no temperature sensor is installed, do not set this parameter)		
Set the charge current limit according to your needs. Setting range: 0.1 ~ 0.25C ₁₀ . (By default: 0.1C ₁₀)		
Set the controller according to the voltage suggested by the battery supplier. Floating Charge (FC) voltage range: 42V ~ Boost Charge (BC) voltage. Default: 53.5V. BC voltage range: FC voltage ~ 58V. By default: 56.4V. For batteries that do not need BC, set the BC voltage to FC voltage plus 0.1V		
Measure the battery voltage with a multimeter and record it. Enter Main menu → Maintenance (password: 1) → RectTrim submenu. Set the output voltage of the rectifier to the value of the battery voltage. Insert the battery fuse. Set the output voltage of the rectifier to 53.5V		
Enter the Basic Setting submenu. Set the 'Sys Mode' parameter to 'Auto'		

3.3 Alarm Check And System Operation Status Check

Alarm check

Check that all functional units can trigger alarms that can be displayed on the controller.

Check item	OK	Comments
Pull out one rectifier. The 'Rect N Com Failure' alarm should be triggered. Insert the rectifier in, the alarm should disappear. Repeat the same procedures on other rectifiers		
Pull out battery MCB 1. The 'Batt1 Failure' alarm should be triggered. Switch on the MCB, the alarm should be cleared. Repeat the same on battery MCB 2		
Switch off a load MCB connected to a load route. The alarm 'Load Fuse Failure' should be triggered. Switch on the MCB, and the alarm should be cleared. Repeat the same on the other load MCBs		
Remove all the battery MCBs. Keep only one rectifier in operation. Through the controller, adjust the rectifier FC voltage to make it lower than the alarm point. The alarm 'DC Voltage Low' should be triggered		
Keep the rectifiers in operation. Set 'Sys Mode' to 'Manual' through the controller. Enter the Maintenance menu at the controller, set 'Batt' to 'Disconnect' and confirm it. the battery protection contactor should be open, and the 'BLVD' alarm should be displayed at the controller. Test the LLVD function according to the same methods		
Pull out the varistor of the AC SPD. The 'SPD fault' alarm should be triggered. Insert the varistor, the alarm should be cleared		
Note: when the preceding alarms are generated, the controller will give alarms after approximately 3s. Refer to 4.5 <i>Querying Alarms</i> for methods of querying alarms		

System operation status check

There should be no alarms during normal system operation. The system operation status check can be conducted through the controller.

For the parameter query method, refer to 4.3 *Querying System Main Information* and 4.4 *Querying Rectifier Status*.

Check item	OK	Comments
The system model is 48V/SET	<input type="checkbox"/>	
The controller should display the correct AC voltage	<input type="checkbox"/>	
The difference between the DC voltage displayed on the controller and the actual voltage should be less than $\pm 0.3V$	<input type="checkbox"/>	
The difference between the battery current displayed on the controller and the actual battery current should be less than 1%	<input type="checkbox"/>	
Check the number of the rectifier displayed on the controller. The number should be consistent with the actual number	<input type="checkbox"/>	
Check the voltage, current, current limiting point of rectifiers displayed on the controller. They should agree with the actual parameters	<input type="checkbox"/>	
For the system configured with temperature sensor, the controller should be able to display the normal battery temperature and ambient temperature. Hold the probe of the temperature sensor with hand and watch the controller, which should display the change of temperature	<input type="checkbox"/>	

3.4 Final Steps

Check item	OK	Comments
Make sure that materials irrelevant to the equipment have been all removed	<input type="checkbox"/>	
Fill in the installation report and hand it over to the user	<input type="checkbox"/>	
Fill in the parameter table at the cabinet door	<input type="checkbox"/>	

If any defect is found in this equipment, inform the personnel responsible for the contract.

If repairing is needed, please fill in the FAILURE REPORT and send the report together with the defective unit to the repairing center for fault analysis.

Chapter 4 Use Of The Controller

This chapter introduces the indicators and functional keys of the controller panel briefly, and expounds screen contents, access method, system controlling, information querying and parameter setting.

After the controller is powered on, the language selection screen will pop up, and the controller is initialized. The default language is Chinese. After the initialization, the first system information page will appear.

4.1 Front Panel

The front panel of the controller provides backlit LCD, functional keypad, indicators and positioning pin, as shown in Figure 4-1.

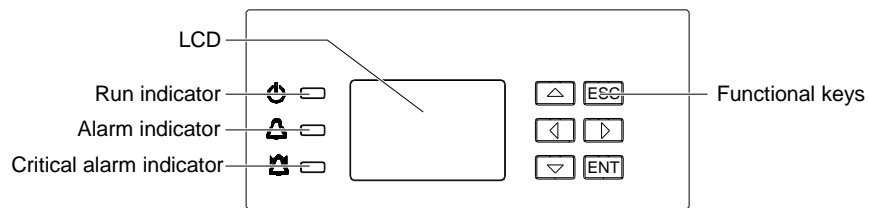

Figure 4-1 Front panel of the controller

Description of the indicators on the front panel of the controller is given in Table 4-1.

Table 4-1 Controller indicator description

Indicator	Color	Normal state	Fault state	Fault cause
Run indicator	Green	On	Off	No operation power supply
Alarm indicator	Yellow	Off	On	There are observation alarms
Critical alarm indicator	Red	Off	On	There are major or critical alarms

The controller uses a 128 × 64 LCD, and a keypad with six keys (listed in Table 4-2). The interface language is Chinese/English optional. The user interface is simply and effective. It is easy to remove and replace the controller panel.

Table 4-2 Description of controller keypad

Screenprint	Name	Function
ESC	Return key	Return to the upper level menu. When the audible alarm tone is generated, press ESC to cancel the alert
ENT	Enter key	Enter the main menu or confirm the menu operation. When changing or inputting parameters, press ENT to get into editing state. After any change is made, press ENT to validate the change
▲	Up key	Shift among parallel menus. For a character string, these two keys can be used to shift among different options
▼	Down key	
◀	Left key	Change values at a value setting interface. For a character string, these two keys can move the cursor left or right
▶	Right key	

4.2 Main LCD Pages

The following LCD pages will be referred to in this chapter for many times. This section is a centralized introduction to the displayed contents and accessing methods of these LCD pages.

4.2.1 System Information Page

When the controller is powered on, the language selection page will appear and the controller will be initialized. The default language is English. After initialization, the first page of system information will appear.

The system information page shows the main information which is displayed on five pages. You can press ▲ or ▼ repeatedly to select different system information pages. The first system information page is shown in Figure 4-2. At this page, you may press ◀ and ▶ to adjust the LCD contrast (7-level).

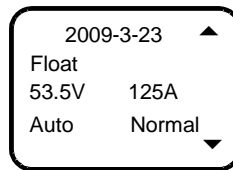

Figure 4-2 First system information page

1. After initialization, the first system information page appears.
2. At the Main Menu page, press ESC to return to the first system information page.
3. If no operation is conducted on the controller keypad for 8 minutes, the LCD will return to the first system information page. The time of that return will be recorded automatically, and can be queried through the host.
4. At any system information page, press ESC to display the serial No. of the controller, the software version and runtime.
5. At the system information page, press and hold the ESC and ENT at the same time for several seconds, the controller will be reset and restart.

4.2.2 Enter Password Page

During the operation, the system will prompt you to enter password, as shown in Figure 4-3. Only the correct password will allow you to enter the page you need.

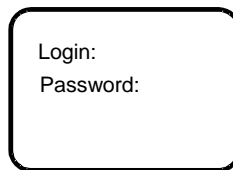

Figure 4-3 Confirming password page

1. When inputting the password, press ENT to get into editing state, use ▲ or ▼ to modify numbers, and use ◀ or ▶ to move the cursor. After the input, press ENT to confirm.
2. If the password is correct, the system will enter the following page, or the system will prompt 'Password incorrect'.
3. Press ESC to return to MAINMENU page.
4. The system has three different password levels: user level (default: 1), engineer level (default: 2) and administrator level (default: 640275).

Once you input the correct password, you never need to input the password again during the operation. While the interval time for adjacent operation is more than four minutes, the system will prompt you to input the password again. If you want to enter senior setting pages, you need to wait four minutes and cannot do any operation during waiting, and then the system will enter the senior setting pages after you input the higher level password. If the two level passwords are the same, the system will display the senior menus after you enter the password.

4.2.3 MAINMENU Page

MAINMENU page is the highest-level menu. At the sub-menus of this page, you can query the settings, controls, rectifier information and alarm information of the system, as shown in Figure 4-4.

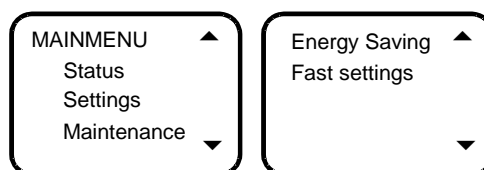

Figure 4-4 MAINMENU page

1. At any system information page, press ENT to enter the MAINMENU page.

2. At any sub-menu of the MAINMENU page, press ESC repeatedly to return to the higher-level menu, and ultimately to the MAINMENU page.

4.2.4 STATUS Page

The STATUS page is a sub-menu of the Main Menu. It contains three sub-menus, including Rectifiers, Active Alarm and History Alarm, as shown in Figure 4-5.

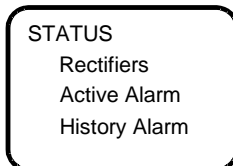

Figure 4-5 STATUS page

1. At the MAINMENU page, press ▲ or ▼ to select the STATUS menu, and press ENT to confirm.
2. At any sub-menu of the STATUS page, press ESC repeatedly to return to the higher-level menu, and ultimately to STATUS page.

4.2.5 Settings Page

Displayed in two pages, the Settings page is a sub-menu of the MAINMENU. It is used to set system parameters. The Setting page has password protection. Input the correct password to enter the Settings page, as shown in Figure 4-6.

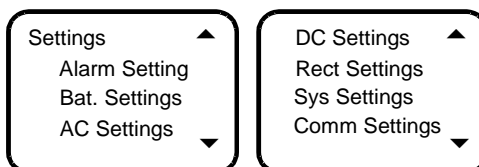

Figure 4-6 Settings page

1. At the MAINMENU page, press ▲ or ▼ to select the Settings menu, and press ENT to confirm. System will then prompt you to input the password.
2. Input the correct password and press ENT to enter the Settings page. Press ▲ or ▼ to scroll to the operation page you need.

Users with different password level have different authorities. See Table 4-3.

Table 4-3 Different password levels and relevant different authorities

Level	Authority	Default password
User	Configuration of general parameters	1
Engineer	User's authority, plus resetting system, resetting password and modifying system type	2
Administrator	Engineer's authority, plus modifying password of all levels, controlling alarm volume, browsing system parameters configured by host	640275

Once you enter the correct password, you never need to enter the password again during the operation. While the interval time for adjacent operation is more than four minutes, the system will prompt you to input the password again. If you want to enter senior setting pages, you need to wait four minutes and cannot do any operation during waiting, and then the system will enter the senior setting pages after you input the higher level password. If the two level passwords are the same, the system will display the senior menus after you enter the password.

4.2.6 Maintenance Page

Displayed in two pages, the Maintenance page is a sub-menu of the MAINMENU. It is used to control the system in real time. You can enter the Maintenance page after you input the correct password. For this menu, the user, engineer and administrator have the same authorities. The Maintenance page is shown in Figure 4-7.

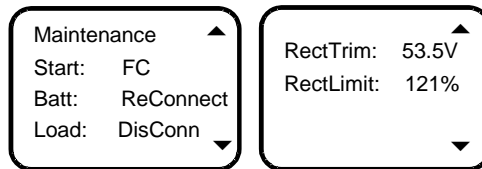

Figure 4-7 Maintenance page

1. At the MAINMENU page, press ▲ or ▼ to select the Maintenance menu, and press ENT to confirm. The system will prompt you to input the password when the battery management mode is set to Manual (see 4.7.2 *Battery Settings*).
2. Input the correct password and press ENT to enter the Maintenance page. Press ▲ or ▼ to scroll to the operation page you need.

4.2.7 Energy Saving Page

The Energy Saving page is a sub-menu of the MAINMENU, as shown in Figure 4-8. It is used to energy relevant parameters.

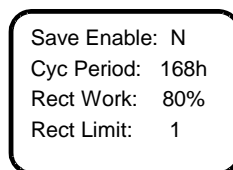

Figure 4-8 Energy Saving page

1. At the MAINMENU page, press ▲ or ▼ to select Energy Saving, and press ENT to confirm. The system will prompt you to input the password.
2. Input the correct password and press ENT to enter the Energy Saving page. Press ▲ or ▼ to select the parameters you need.

4.2.8 Fast Settings Page

The Fast Settings page is a sub-menu of the MAINMENU, as shown in Figure 4-9. It is used to set system type and battery capacity.

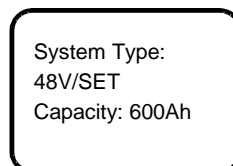

Figure 4-9 Fast Settings page

1. At the MAINMENU page, press ▲ or ▼ to select Fast Settings, and press ENT to confirm. The system will prompt you to input the password.
2. Input the correct password and press ENT to enter the Fast Settings page. Press ▲ or ▼ to select the parameters you need.

4.3 Querying System Main Information

DC, system operation state, battery state and energy management mode information.

At any system information page, press ▲ or ▼ repeatedly to select the first system information page. At other pages, press ESC repeatedly to return to the first system information page. DC voltage and current, system operation state, battery state and battery management mode are displayed in the first system information page, as shown in Figure 4-10.

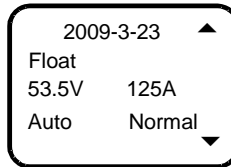

Figure 4-10 First system information page

The date and time are displayed at the interval of 2s. System operation state contains No Alarm and Alarm. Battery management mode includes Auto and Manual. Battery state includes Float charge, Temp Comp, Boost charge, Cyclic Boost, Batt. Test, ShortTest and TimeTest.

Save state, rectifier output power and Cyc BC After information

At the AC information page, press ▼ to enter the following page. The system will display the Save Stat, Sys Used and Cyc BC After information, as shown in Figure 4-11.

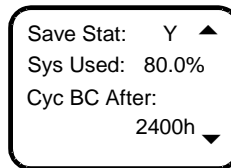

Figure 4-11 Sys Used and Cyc BC After information page

The first line displays the save state. The second line displays the percentage between the output power and rated power of the rectifier. The lower line displays the BC prompt information, they will be different for different states of the system, including:

1. Prompt the time of the next Cyclic BC according to the battery state.
2. If BC is going on or prohibited, '---' will be prompted.

Battery information

At the first system information page, press ▼ to query the battery information, as shown in Figure 4-12.

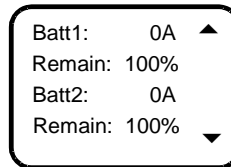

Figure 4-12 Battery information page

As shown in the preceding page, the Batt1 and the Batt2 represent respectively the current of the battery shunt 1 and shunt 2. If multi-group batteries are connected to the same shunt, the displayed current is the total current of the multi-group batteries. If the Shunt Coeff of certain battery group is set to No, the corresponding battery information page will display 'Disconnected', and the remaining capacity will not be displayed.

The remaining battery capacity can be displayed in the mode of percentage, remaining Ah or remaining time. The default is the percentage.

AC information

At the battery information page, press ▼ to display AC information page. The system will display AC voltage of the A, B and C phases, as shown in Figure 4-13.

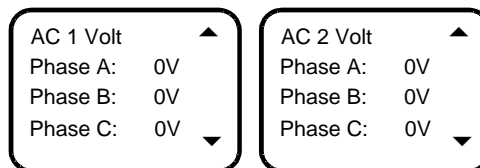

Figure 4-13 AC information page

System temperature information

At the Sys Used page, press ▼ to enter the system temperature information page. If a temperature sensor is configured, the system will display a page on Bat. Temp and Amb. Temp, as shown in Figure 4-14.

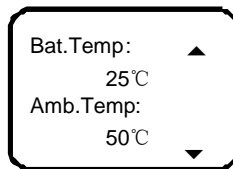

Figure 4-14 Bat. Temp and Amb. Temp page

If the temperature sensor is not connected or is faulty, the system will prompt '---', meanwhile, alarm information will be displayed. If the controller bans BC and no temperature sensor is configured, this page will not be displayed.

4.4 Querying Rectifier Status

Note

If the controller has not detected rectifiers, you cannot query the rectifier information.

The rectifier information includes the rectifier serial No., voltage, current, current limit, AC input voltage, mains situation, rectifier power limit and temperature power limit.

At the STATUS page (see Figure 4-5), press ▲ or ▼ to select the Rectifiers sub-menu, press ENT to enter the rectifier information page shown in Figure 4-15.

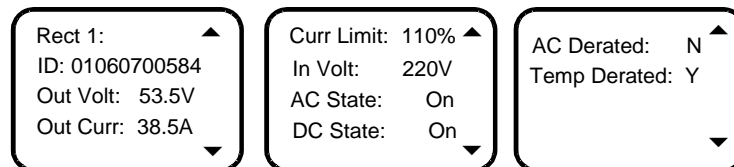

Figure 4-15 Rectifier information page

The information of every rectifier is displayed in three pages. Press ▲ or ▼ to scroll to between three pages, press ◀ and ▶ to shift between rectifiers.

At most 24 pieces of rectifier information can be displayed. When selecting one rectifier, the green indicator of the corresponding rectifier will blink. If the rectifier communication is interrupted, the information will be displayed in high light.

4.5 Querying Alarms

You can query historical alarms and active alarms through the LCD of the controller.

4.5.1 Querying Active Alarm

When a new alarm is raised, and there is no operation on controller keypad within two minutes, the LCD of the controller will prompt the active alarm automatically. Follow the procedures below to query the detailed information of the current alarms.

At the STATUS page (see Figure 4-5), press ▲ or ▼ to select Active Alarm menu. Press ENT to confirm.

1. If there is no active alarm, you cannot enter the alarm prompt screen. If there are former alarms, you can enter the active alarm page, the alarm will disappear, and 'None' will be displayed.
2. If there is any alarm, the display will be like the page shown in Figure 4-16.

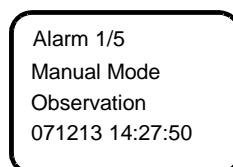

Figure 4-16 Active alarm page

The preceding page includes alarm serial No., alarm name, alarm level and time. The alarm raising time determines the sequence it is displayed, with the latest alarm displayed first. Use ▲ or ▼ to view all active alarms.

While querying rectifier alarms, press ► to view rectifier ID, and the Run indicator of the corresponding rectifier will blink.

In the case of battery test alarm or maintenance time alarm, press ► to display the prompt information, then press ENT to confirm that the alarm is cleared. The active alarms in the controller are given in Table 4-4.

Table 4-4 Active alarm

No.	Alarm type	Alarm	Description	
1	Rectifier	Rect AC Fail	Press ► to browse the fault rectifier serial No.	
2		Rect Over temp		
3		Rect Fault		
4		Rect Protect		
5		Rect Fan Fails		
6		Rect Derated		
7		Rect Not Respond		
8		Multi-Rect Alarm		-
9		Rectifr Lostie		Press ► to confirm the alarms. If the interfered rectifiers are reduced, you can clear this alarm manually
1	AC	AC SPD Fault	AC SPD fault is the alarm of Digital 1	
2		Digital Alarm	-	
3		AC High	-	
4		AC LOW	-	
5		AC PH Fail	-	
6		Mains Failure	-	
1	DC	DC Volt High+ , DC Volt High	-	
2		DC Volt Low	-	
3		DC Volt Low-	-	
4		Batt Over temp	-	
5		Batt Temp High Alarm	-	
6		Batt Temp Low Alarm	-	
7		Ambient Temp High Alarm	-	
8		Ambient Temp Low Alarm	-	
9		T1 No Probe	-	
10		T2 No Probe	-	
11		Sensor 1 Fault	-	
12		Sensor 2 Fault	-	
13		LVD	-	
14		BLVD	-	
15		Load Fuse Alarm 1	-	
16		Load Fuse Alarm 2	-	
17		Load Fuse Alarm 3	-	
18		Load Fuse Alarm 4	-	
19		Load Fuse Alarm 5	-	
20		Load Fuse Alarm 6	-	
21		Load Fuse Alarm 7	-	
22		Load Fuse Alarm 8	-	
23		Load Fuse Alarm 9	-	
24		Aux Load Fails	-	
25		Batt Fuse Alarm 1	-	
26		Batt Fuse Alarm 2	-	
27		Batt Fuse Alarm 3	-	
28		Batt Fuse Alarm 4	-	
29		Batt 1 Curr High	-	
1	Battery management	Non Float Status	-	
2		Batt Discharge	-	
3		Load share Alarm	-	

No.	Alarm type	Alarm	Description
4	Battery management	Batt Test Fail	Press ► to prompt you to clear this alarm
5		Short Test Fail	
6		Save Power	-
7		Save Power Fault	-
1	Monitoring self-detect	SelfDetect Fail	-
2		Manual Mode	-
3		Volt Discrepancy	-
4		Maintain Alarm	-
5		Alarm Block	-

4.5.2 Querying History Alarm

1. At the STATUS page (see Figure 4-5), press ▲ or ▼ to select History Alarm menu. Press ENT to confirm.
 - 1) If there is no history alarm, the system cannot enter the lower level menu.
 - 2) If there is history alarm, the page shown in Figure 4-17 will be displayed.

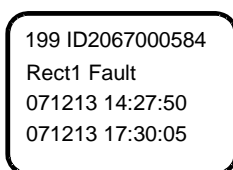

Figure 4-17 History alarm page

If the alarm is a rectifier related alarm, the first line in Figure 4-17 will display the latter 10 number of the rectifier ID. The history alarms of the controller are stored in cyclic order. Up to 200 alarms will be recorded. Above that, the earliest alarm will be cleared automatically.

2. Use ▲ or ▼ to view other history alarms.
3. At any History Alarm page, press ESC repeatedly to return to the first system information page.

4.6 Maintenance

Note

Be careful! BLVD operations may result in power interruption.

1. At the battery basic parameter setting page (see Figure 4-24), change the battery management mode from Auto to Manual. Press ENT to confirm. For the detailed procedures, see *Basic* in 4.7.2 *Battery Settings*.
2. At the MAINMENU page, press ▲ or ▼ to select the Maintenance menu. Press ENT and the system will prompt you to enter the password.
3. Input the password and press ENT to enter the Maintenance page, as shown in Figure 4-18.

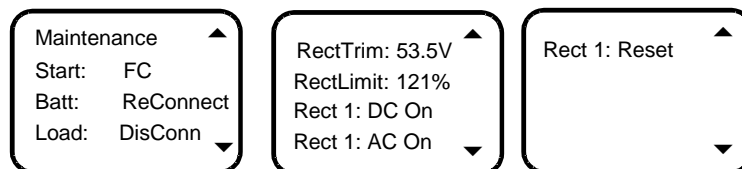

Figure 4-18 Maintenance page

4. Use ◀ or ▶ to select the needed action. After the input, press ENT to confirm or ESC to cancel.
 - 1) Start: The options include FC, BC and Test. Press ◀ or ▶ to select the needed action. If there is AC power off alarm, or the busbar voltage is too low, the BC and battery test control will not be executed by the system. No battery test control can be conducted when the rectifier communication is interrupted. Finally, after the battery test, the battery management mode will be changed from Manual to Auto automatically.
 - 2) Battery: The options include Reconnect and Disconnect. If there is a battery alarm, the battery operations will be invalid.

- 3) Load: The options include Reconnect and Disconnect.
- 4) RectTrim: Range: 42V ~ 58V. The value of this parameter cannot exceed the over-voltage alarm point, otherwise, the parameter will be invalid.
- 5) RectLimit: Range: 10% ~ 121%.
- 6) Rect N: The maintenance operations over a single rectifier include: DC ON/OFF, AC ON/OFF and Reset.

The Operation method:

- 1) Use ▲ or ▼ to select the rectifier parameter, and ◀ or ▶ to change the rectifier serial No. Then press ENT to confirm. The bottom line of the page displays the rectifier ID.
- 2) Use ▲ or ▼ to move the cursor to the maintenance operation area (that is DC On in Figure 4-18), and ◀ or ▶ to select the value.

If the rectifier voltage is too high, you can select Reset to restore the output voltage of that rectifier to normal. In this time, if the over-voltage fault is cleared, the rectifier will work normally; if the fault persists, the over-voltage protection will be occurred in the rectifier. Only in FC status, can the control order on the RectTrim, RectLomit and single rectifier be executed.

5. Press ESC to return to the MAINMENU page and change the battery management mode from Manual to Auto. And then press ESC to return to the system information page.

4.7 Setting

The system parameters are divided into seven kinds: alarm, battery, AC, DC, rectifier, system and communication parameters. Without any special needs, you only need to reset the battery group and battery capacity according to system configuration, and accept the defaults for other parameters.

4.7.1 Alarm Settings

At the Settings page, press ▲ or ▼ to select Alarm Settings menu. Then press ENT to enter the Alarm Settings page, as shown in Figure 4-19.

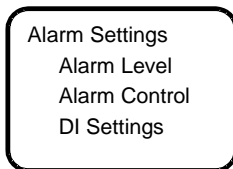

Figure 4-19 Alarm Settings page

There are three sub-menus as follows.

Setting alarm level

At the Alarm Settings page, press ▲ or ▼ to select Alarm Level menu. Then press ENT to enter the Alarm Level page, as shown in Figure 4-20.

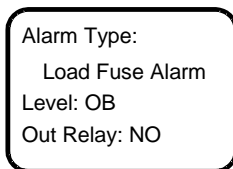

Figure 4-20 Alarm Level page

Press ▲ or ▼ to move the cursor to the needed option. Press ◀ or ▶ to select the corresponding content and press ENT to confirm.

The controller alarms are classified into four types: critical alarm, major alarm, observation and no alarm.

Critical alarm, major alarm: These two types of alarms have strong impacts on the system performance. Whenever these alarms are generated, you are supposed to handle them immediately. The alarm indicators will be on and audible indication will be given.

Observation: When this type of alarm is raised, the system maintains normal output for a while. If the alarm occurs during watch time, it should be handled immediately. If the alarm occurs during non- watch- time, handle it during watch time. The alarm indicators will be on when observation alarm occurs.

No alarm: The system will not generate a visible or audible indication.

The alarm default value of the controller is listed in Table 4-5.

Table 4-5 Alarm setting parameter description

No.	Alarm	Description	Alarm level	Related relay	Related parameter
1	SPD Fault	SPD failure	Major	None	-
2	DI	Defined the alarm name by user, at most 10 letters. In this system, eight DIs can be defined. Among which, the first DI is defined as SPD Fault, the remained seven DI can be defined freely	No alarm	None	-
3	AC Voltage High	AC input voltage higher than the setting of 'AC input over- voltage alarm point'	Major	None	Over- voltage alarm
4	AC Voltage Low	AC input voltage lower than the setting of 'AC input under- voltage alarm point'	Major	None	Low- voltage alarm
5	Mains Failure	All the AC input voltages from the rectifier are less than 80V	Critical	1	-
6	DC Volt High	DC output voltage higher than the setting of 'DC output over- voltage alarm point'	Major	2	Over- voltage alarm
7	DC Volt Low	DC output voltage lower than the setting of 'DC output low- voltage alarm point'	Major	2	Low- voltage alarm
8	DC Volt Under	DC output voltage lower than the setting of 'DC output under- voltage alarm point'	No alarm	None	Under- voltage alarm
9	Batt Over Temp	Battery temperature higher than the setting of Temp	Critical	None	Over Temp alarm point
10	Batt Temp High Alarm	Battery temperature higher than the setting of Temp	Observation	None	High Temp alarm point
11	Batt Temp Low Alarm	Battery temperature lower than the setting of Temp	Observation	None	Low Temp alarm point
12	Ambient Temp High Alarm	Ambient temperature higher than the setting of Temp	Observation	None	High Temp alarm point
13	Ambient Temp Low Alarm	Ambient temperature lower than the setting of Temp	Observation	None	Low Temp alarm point
14	T1 No Probe	Configured with temperature sensor 1 but not connected	Major	None	-
15	T2 No Probe	Configured with temperature sensor 2 but not connected	Major	None	-
16	Sensor 1 Fault	Temperature sensor 1 measures unreasonable temperature	Major	None	-
17	Sensor 2 Fault	Temperature sensor 2 measures unreasonable temperature	Major	None	-
18	LVD 1	Load low voltage disconnects	Major	5	LLVD enabled
19	LVD 2	Battery low voltage disconnects	Major	4	BLVD enabled
20	Load Fuse Alarm 1 ~ 9	Load failure caused by overload, short circuit, manual disconnect, and alarm circuit failure	Major	None	-
21	Aux Load Fails	The last load fuse failure	Major	None	-
22	Batt Fuse Alarm 1 ~ 4	Battery failure caused by overload, short circuit, manual disconnect, and alarm circuit failure	Major	None	-
23	Batt 1 Curr High	Charging current of battery string 1 higher than the setting of 'Over' (Charging over current limit)	Observation	None	Over (over current point)
24	Batt 2 Curr High	Charging current of battery string 2 higher than the setting of 'Over' (Charging over current limit)	Observation	None	Over (over current point)
25	Rect AC Fail	AC input voltage of this rectifier lower than low- voltage alarm point	Critical	3	-
26	Rect Over Temp	The internal temperature of the rectifier is higher than 90°	Observation	3	-
27	Rect Failure	The rectifier voltage is higher than upper limit voltage	Major	3	-
28	Rect Protect	Rectifier performs self- protection and has no output	Observation	3	-
29	Rect Fan Fails	Rectifier fan fails	Critical	3	-

No.	Alarm	Description	Alarm level	Related relay	Related parameter
30	Rect Derated	Rectifier limits its output power	Observation	3	-
31	Rect Not Respond	Rectifier does not communicate with the controller	Critical	3	-
32	HVSD	Rectifier shut down under high voltage		3	-
33	Multi-Rect Alarm	More than two rectifiers alarm	Major	None	-
34	Self-detect Err	Hardware Self-detect Error	No alarm	None	-
35	Manual Mode	Battery management is in manual control mode	No alarm	None	-
36	Non Float Status	Battery is not under float status	No alarm	None	-
37	Batt Discharge	Battery is discharging	No alarm	None	-
38	Load share Alarm	In the system with load current shunt, the sampled load current plus battery current differs greatly from rectifier current	No alarm	3	-
39	Batt Test Fail	Battery discharging time is shorter than expected	Observation	None	-
40	Short Test Fail	In short test, battery discharging capacity is bigger than setting value	Observation	None	-
41	Volt Discrepancy	Actual output voltage is different from both the measured DC bus voltage and different from the voltage reported by the rectifier to controller. The error is bigger than 1V	Observation	None	-
42	Maintain Alarm	Exceed the set maintain time	Observation	None	-
43	Rectifier Lost	The controller has detected a reduction in the number of running rectifiers	Major	None	-
44	Save Power	The system is running under energy saving status	No alarm	None	-

Setting alarm control

At the Alarm Settings page, press ▲ or ▼ to select Alarm Control menu. Then press ENT to enter the Alarm Control page, as shown in Figure 4-21.

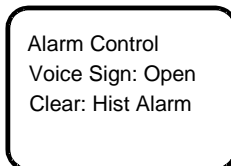

Figure 4-21 Alarm Control page

Voice Sign option: open/ off/ 3min/ 10min/ 1h/ 4h. You can set according to you requirement.

‘Clear: Hist Alarm’ option: His Alarm, Rect Lost, TestFail, ShortTest, ESaveFail and Maintain. Press ENT to clear the saved alarm information in the controller.

DI settings

Only when the costumed DI triggers alarm, the DI Setting is valid, At the Alarm Settings page, press ▲ or ▼ to select DI Settings menu. Then press ENT to enter the DI Settings page, as shown in Figure 4-22.

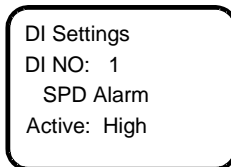

Figure 4-22 DI Settings page

Press ▲ or ▼ to select the needed option. Press ◀ or ▶ to select the parameter value and press ENT to confirm. Press ▲ or ▼ to modify the number and letter of DI name on the third line after pressing the ENT to confirm, press ◀ or ▶ to move the cursor left or right and input ‘#’ to end. Finally, press ENT to confirm.

The value description of the parameter is listed in Table 4-6.

Table 4-6 Alarm setting parameter description

Parameter	Range	Factory setting	Value description
DI No.	1 ~ 8	8	The eighth corresponding connecting terminals, queued up in the order that the hardware switches are put
DI Name	Figures or letters, 10 at most	SPD	When there are DI alarms, this parameter shows the alarm name you have actually defined
Alarm Mode	High, Low	Low	High: alarm upon high level; Low: alarm upon low level

4.7.2 Battery Settings

Battery parameters are very important, for they are related to the life of battery.

At the Settings page, press ▲ or ▼ to select Bat. Settings menu. Then press ENT to enter the BAT Settings page, as shown in Figure 4-23.

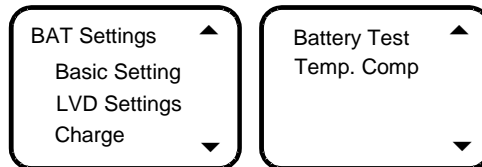

Figure 4-23 BAT Settings page

The battery parameters are divided into 5 kinds: basic, LVD, charging management, battery test and temperature coefficient parameters.

Basic setting

1. At the BAT Settings page, press ▲ or ▼ to select Basic Setting menu. Then press ENT to enter the battery basic parameter setting page, as shown in Figure 4-24.

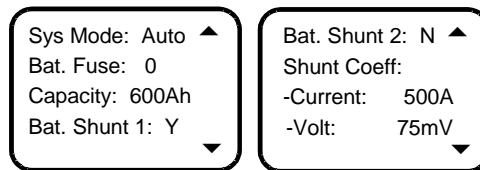

Figure 4-24 Battery basic parameter setting page

2. Press ▲ or ▼ to select one page or one of the parameters, and press ◀ or ▶ to select the parameter value. Then press ENT to confirm and save.

The value description of the basic battery parameters is listed in Table 4-7.

Table 4-7 Basic battery parameters descriptions

Parameter	Range	Factory setting	Value description
Sys Mode	Auto, Manual	Auto	In the Auto mode, you can manage the system through the controller. In the Manual mode, you can manage the system manually, as well as calculate battery BC time protection and capacity automatically. Upon the system DC under-voltage alarm, system can automatically switch to the Auto mode
Bat. Fuse	0 ~ 4	4	You should set this parameter according to the actual battery configuration
Capacity	50Ah ~ 5000Ah	300Ah	The capacity of the total battery strings. You should set this parameter according to the actual battery configuration
Bat. Shunt1	Y, N	Y	You can set shunt parameters when 'System Type' is 'SET'
Bat. Shunt2		N	
Shunt Coeff Current	1A ~ 5000A	NetSure 531 AC1-Y1: 300A; NetSure 531 AC1-Y6, NetSure 531 AC1-W6: 150A	
Shunt Coeff Volt		1mV ~ 500mV	

LVD parameters

At the BAT Settings page, press ▲ or ▼ to select LVD Setting menu. Then press ENT to enter LVD settings page, as shown in Figure 4-25.

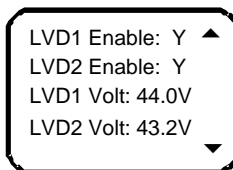

Figure 4-25 LVD settings page

Press ▲ or ▼ to select the parameter, and ◀ or ▶ to select the parameter value. Then press ENT to confirm.

LVD1 means the controller opens the LLVD contactor, so that the non-priority load will be powered off. In this way, the battery remaining capacity can sustain the priority load longer.

LVD2 means the controller opens the BLVD contactor. In this way, the battery will stop powering the load, preventing over-discharge.

The value description of the LVD parameters is listed in Table 4-8.

Table 4-8 LVD parameters description

Parameter	Range	Factory setting	Value description
LVD1 Enable	Y, N	Y	Select 'Y' to enable LVD1/ LVD2 function
LVD2 Enable		Y	Select 'N' to disable the LVD1/ LVD2 function
LVD1 Volt	40V ~ 60V	44.0V	Select Voltage, when the controller detects that the battery voltage is lower than the preset LVD1 Volt
LVD2 Volt		43.2V	Select Voltage, when the controller detects that the battery voltage is lower than the preset LVD2 Volt

Charge management parameters

At the BAT Settings page, press ▲ or ▼ to select Charge menu. Then press ENT to confirm.

There are five pages, as shown in Figure 4-26.

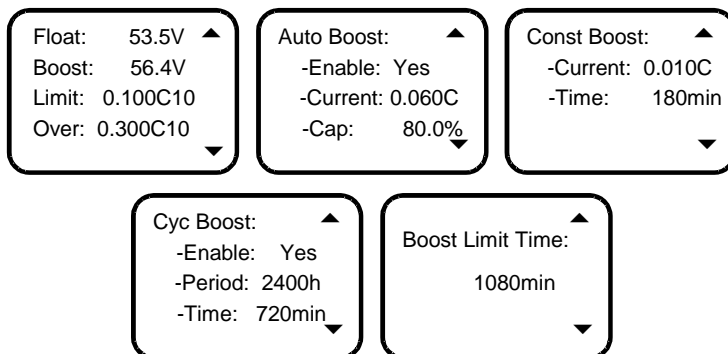

Figure 4-26 Charge management settings page

Press ▲ or ▼ to select the parameter, and ◀ or ▶ to select the parameter value. Then press ENT to confirm.

The charging management parameter value description is listed in Table 4-9.

Table 4-9 Charging management parameter value description

Parameter	Range	Factory setting	Value description
Float	42V ~ 58V	53.5V	The output voltage of the rectifier upon the FC state
Boost		56.4V	The output voltage of the rectifier upon the BC state. The Boost must be higher than the Float
Limit (current limit point)	0.1C ₁₀ ~ 0.25C ₁₀	0.1C ₁₀	Max. value of the charging current. C ₁₀ is the battery rated capacity, generally set to 10% ~ 20% of the rated capacity of one battery string
Over (over current point)	0.3C ₁₀ ~ 1.0C ₁₀	0.3C ₁₀	If the battery charging current is higher than the Over, it will raise the battery charge over-current alarm

Parameter	Range	Factory setting	Value description
Auto Boost Enable	Y, N	Y	Select 'Y' to enable this function Select 'N' to disable this function
Auto Boost Current	0.050C ₁₀ ~ 0.080C ₁₀	0.06C ₁₀	If the Automatic Boost function is enabled, the controller will control the system enter the BC state when the battery capacity decreases to the set value of Auto Boost Cap, or when the charge current reaches the Auto Boost Current. The charge voltage will be the set valut of Boost
Auto Boost Cap	10% ~ 99%	80%	
Const Boost Current	0.002C ₁₀ ~ 0.02C ₁₀	0.01C ₁₀	When the charge current decreases to the set value of Const Boost Current, the system in the BC state will still be in BC state for some time set in Const Boost Time. After that, the system in the BC state will enter the FC state
Const Boost Time	30min ~ 1440min	180min	
Cyc Boost Enable	Y, N	Y	Select 'Y' to enable this function Select 'N' to disable this function
Cyc Boost Period	48h ~ 8760h	2400h	'Cyc Boost Period' indicates the time interval between twice boost charge. The battery charging voltage is the preset Boost, and the charging time is the preset Cyclic Boost Time
Cyc Boost Time	30min ~ 2880min	720min	
Boost Limit Time	60min ~ 2880min	1080min	To ensure safety, the controller will forcefully control the power supply system to enter the FC state during the BC state when the BC time reaches the preset Boost Limit Time

The BC/FC switchover diagram is shown in Figure 4-27.

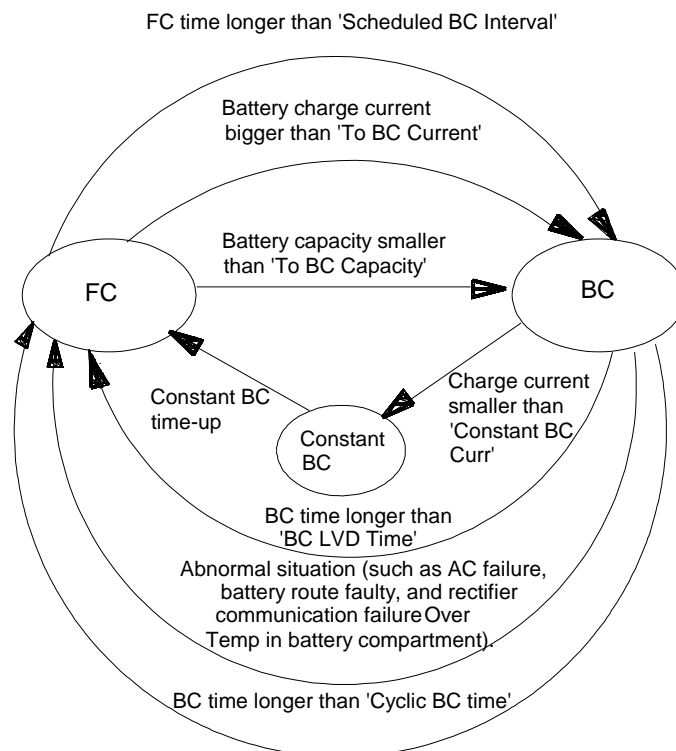

Figure 4-27 BC/FC switchover diagram

Battery test parameters

1. At the BAT Settings page, press ▲ or ▼ to select Battery Test menu. Then press ENT to confirm.

There are five pages, as shown in Figure 4-28.

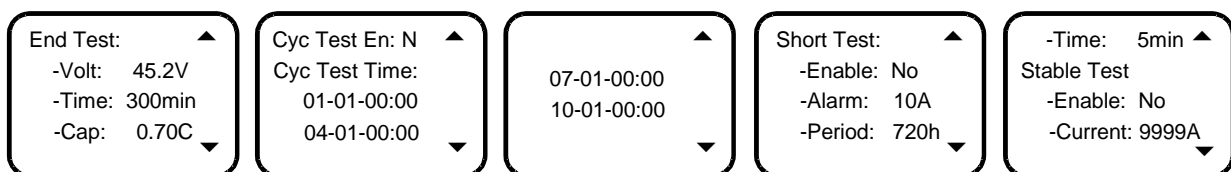

Figure 4-28 Battery test settings page

2. Press ▲ or ▼ to select one page or one of the parameters, and ◀ or ▶ to select the parameter value. Then press ENT to confirm and save.

The controller can do battery test, and record 10 sets of test data (accessible only through the host). The battery test has to be started manually, then the controller will control the rectifier output voltage, make it lower than the battery voltage, and the battery discharge will begin. The controller will stop the test if the battery voltage reaches the Battery Test Voltage, or the discharge time reaches Battery Test Time, or the battery capacity reaches Test End Cap. Afterwards, it will restore the rectifier output voltage to the normal FC voltage, begin the battery charge and switch the system to battery auto-management.

Meanwhile the test start time/voltage and end time/voltage and battery remaining capacity will be recorded. The records can be queried through the host. During the battery test, if abnormalities occur, the controller will stop the battery test automatically.

The value description of the parameters is listed in Table 4-10.

Table 4-10 Battery test parameters description

Parameter	Range	Factory setting	Value description
End Test Volt	43.1V ~ 57.9V	45.2V	The controller will stop the test and change to FC if the battery voltage reaches the End Test Volt, or the discharge time reaches End Test Time, or the battery capacity reaches End Test Cap
End Test Time	5min ~ 1440min	300min	
End Test Cap	0.01C ₁₀ ~ 0.95C ₁₀	0.7C ₁₀	
Cyc Test En	Y, N	Y	Select 'Y' to enable this function Select 'N' to disable this function
Cyc Test Time	Month, day, time	01-01-00:00	When the parameter Cyc Test En is set to Y, the power supply system will test the battery in this set time
		04-01-00:00	
		07-01-00:00	
		10-01-00:00	
Short Test Enable	Y, N	Y	Whether using Short Test function
Short Test Alarm	1A ~ 100A	10A	The Short Test is suitable for the discharge test comparison of two battery groups. If one battery group has not discharged for a long time, these parameters are reference in detecting the battery. If the battery is not discharged within the set time of ShortTest Period, the controller will start a short test, whose operation time is set by the parameter ShortTest Duration. By the end of the test, if the difference between the discharge current of two battery strings is bigger than the Short Test Alarm, the 'Short Test Abnormal' alarm will be raised
Short Test Period	24h ~ 8760h	720h	
Short Test Time	1min ~ 60min	5min	
Stable Test Enable	Y, N	N	The stable test is conducted with constant battery current. If the current load current is higher than the set value of the Stable Test Current, enter the stable test. This test is suitable for the instance that the load is bigger and the load current is stable. It is not recommended if the load is small. The current value is set through the StableTest Current parameter. If the parameter StableTest Enable is set to Y, and the test will be started once the battery satisfies the test condition
Stable Test Current	0 ~ 9999A	9999A	

The schematic diagram of the test function is shown Figure 4-29.

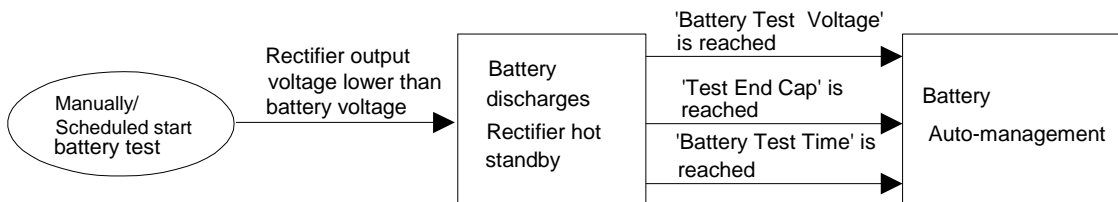

Figure 4-29 Schematic diagram of the test function

Temperature coefficient

1. At the BAT Settings page, press ▲ or ▼ to select Temp. Comp menu. Then press ENT to confirm.

There are two pages, as shown in Figure 4-30.

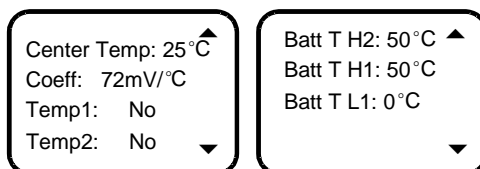

Figure 4-30 Temp. Comp settings page

2. Press ▲ or ▼ to select the parameter, and ◀ or ▶ to select the parameter value. Then press ENT to confirm and save.

The value description of the parameters is listed in Table 4-11.

Table 4-11 Temperature compensation coefficient parameters description

Parameter	Range	Factory setting	Value description
Center Temp	10°C ~ 40°C	25°C	FC = (BattTemp – Center Temp) * Temp Coeff Upon alarms such as Rect Not Respond, DC Volt High, DC Volt Low and Batt Fuse Alarm, the controller will not do temperature compensation to the battery FC voltage
Coeff	0 ~ 500mV/°C	72mV/°C	
Temp1	Ambient Temp, None, Battery Temp	None	Ambient Temp refer to the measurement of the ambient temperature sensor at the local power system.
Temp2			Battery Temp refer to the measurement of the battery temperature sensor at the local power system. None means there is no measurement input
Batt T H2	-40°C ~ 100°C	50°C	When the detected battery temperature is higher than the set value, the controller will raise an alarm.
Batt T H1	-40°C ~ 100°C	50°C	The Batt T H1 must not be higher than the Batt T H2
Batt T L1	-40°C ~ 100°C	0°C	The controller will raise an alarm when the detected battery temperature is lower than Batt T L1

4.7.3 AC Settings

At the Settings page, press ▲ or ▼ to select AC Settings menu. Then press ENT to enter the AC Settings page, as shown in Figure 4-31.

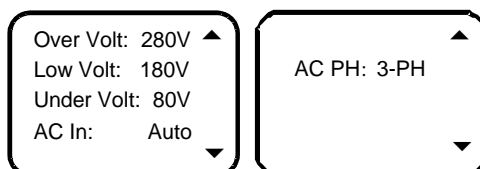

Figure 4-31 AC Settings page

Press ▲ or ▼ to select the parameter, and ◀ or ▶ to select the parameter value. Then press ENT to confirm.

The value description of the parameters is listed in Table 4-12.

Table 4-12 AC setting parameter description

Parameter	Range	Factory setting	Value description
Over Volt	50V ~ 300V	280V	The controller will raise an alarm when the AC input voltage is higher than the Over Volt
Low Volt	50V ~ 300V	180V	The controller will raise an alarm when the AC input voltage is lower than the Low Volt. The value of the Low Volt must be lower than that of the Over Volt
Under Volt	50V ~ 300V	80V	Setting according to actual requirement
AC In	Auto, No, Manual	No	Setting according to the AC input mode of AC sampling board. Choose 'No' if the AC sampling board is not configured
AC PH	1-PH, 3-PH	3-PH	Setting according to the actual configuration. Choose '1-PH' and '3-PH' if the AC sampling board is configured

4.7.4 DC Settings

At the Settings page, press ▲ or ▼ to select DC Settings menu. Then press ENT to enter the DC Settings page, as shown in Figure 4-32.

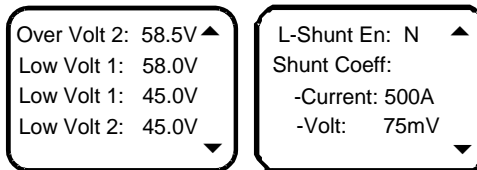

Figure 4-32 DC Settings page

Press ▲ or ▼ to select the parameter, and ◀ or ▶ to select the parameter value. Then press ENT to confirm. The value description of the parameters is listed in Table 4-13.

Table 4-13 DC setting parameter description

Parameter	Range	Factory setting	Value description
Over Volt	40V ~ 60V	58.5V	The DC Over Voltage alarm will be raised when the system DC output voltage is higher than the value of Over Volt
Low Volt 1		45.0V	The DC low voltage alarm will be raised when the system DC output voltage is lower than the value of Low Volt 1. The value of the Low Volt 1 must be lower than that of the Over Volt
Low Volt 2		45.0V	The DC under voltage alarm will be raised when the system DC output voltage is lower than the value of Low Volt 2. The value of the Low Volt 2 must be lower than that of the Low Volt 1
L-Shunt En	Y, N	N	Setting according to the actual instance
Shunt Coeff Current	1A ~ 5000A	-	They can be reset when the shunt options are 'SET' in the system with load shunt
Shunt Coeff Volt	1mV ~ 500mV	-	

4.7.5 Rectifier Settings

At the Settings page, press ▲ or ▼ to select Rect Settings menu. Then press ENT to confirm. There are three pages, as shown in Figure 4-33.

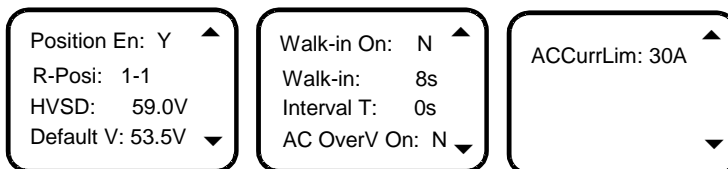

Figure 4-33 Rect Settings page

Press ▲ or ▼ to select the parameter, and ◀ or ▶ to select the parameter value. Then press ENT to confirm. The value description of the parameters is listed in Table 4-14.

Table 4-14 Rectifier parameter description

Parameter	Range	Factory setting	Value description
Position En	Y, N	Y	'Y': The controller will prompt you to set rectifier position before the rectifier and controller are powered on. 'N': You need not to set rectifier position
R-Posi	1 ~ 30	-	R-Posi: represented in two figures, the first figure represents the rectifier number, the next figure represents position number. Press ENT to select the rectifier, press ◀ or ▶ to change position number. When the controller communicates with the rectifier, the green indicator on the corresponding rectifier will blink
HVSD	56V ~ 59V	59V	The rectifier over voltage alarm will be raised when the rectifier output voltage is higher than the HVSD voltage
Default V	48V ~ 58V	53.5V	Default output voltage when communication interrupted. Must be lower than this value

Parameter	Range	Factory setting	Value description
Walk-in On	Y, N	N	The output soft start function means the rectifier voltage will rise from 0V to the Default Volt after the Walk-in time
Walk-in	8s ~ 128s	8s	
Interval T	0s ~ 10s	0s	Set the DCDC Interval Start of the rectifiers. Start time = rectifier address × interval time
AC OverV On	Y, N	N	If you set AC OverV On to 'Y', the rectifier can start forcibly when the AC input overvoltage occurs in the rectifier. The rectifier with least address has this function. If the overvoltage persist for 60s, the function will be canceled automatically
ACCurrLim	1A ~ 50A	30A	The controller limits the input current of the rectifier in the AC current limiting point

4.7.6 System Settings

At the Settings page, press ▲ or ▼ to select Sys Settings menu, then press ENT to enter the password interface. Enter the Basic setting page after inputting the correct password.

After inputting the user level password (by default: 1), three pages as shown in Figure 4-34 are displayed.

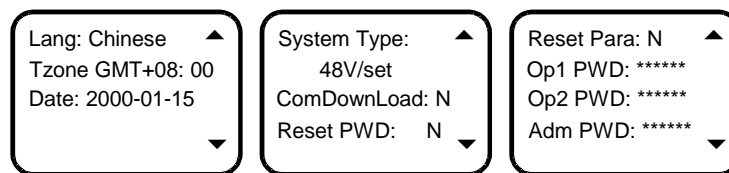

Figure 4-34 Settings page upon user level

If the 'Reset Para' is set to 'Y', press ENT and prompt a page shown in Figure 4-35.

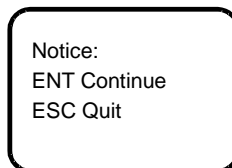

Figure 4-35 Prompt page about resetting system

Press ESC to cancel the resetting. Press ENT to confirm the resetting, in this time, all the parameters will resume the default value. It is recommended to power off or reset the controller when the controller cannot work normally; if the controller still cannot work normally, perform the system resetting.

Press ▲ or ▼ to select the parameter, and ◀ or ▶ to select the parameter value. Then press ENT to confirm.

The value description of the parameters is listed in Table 4-15.

Table 4-15 System setting parameter description

Parameter	Range	Factory setting	Value description
Lang	Chinese, English	Chinese	Set according to your need
Tzone	-	-	Set according to actual instance
Date	2000 ~ 2099	-	Set the time according to the current actual time, regardless of whether it is a leap year or not
System Type	24V/100 24V/300 24V/500 24V/1000 24V/SET 48V/100 48V/300 48V/500 48V/1000 48V/SET	48V/SET	The system type of the controller has been set according to the actual instance before the controller is delivered with power supply system. You need not to change the value except that the controller is replaced with a new one. After changing the type, the controller will restart automatically and the other parameters will resume the default. You need to reset and change some parameters according to the battery and equipment configured with system
ComDownLoad	Y, N	N	-
Reset PWD	Y, N	N	Whether resetting the password to the default
Reset Para	Y, N	N	Whether resetting the parameters to the default

Parameter	Range	Factory setting	Value description
Op1 PWD	-	-	The password can be 6 digits long at most. If it is shorter than 6 digits, end it with a #. Use ▲ or ▼ to change the number, and ◀ or ▶ to move the cursor left or right. Press ENT to confirm. You should input the same number twice to complete the setting
Op2 PWD	-	-	
Adm PWD	-	-	

4.7.7 Communication Settings

At the Settings page, press ▲ or ▼ to select Comm Settings menu. Then press ENT to enter the Communication Settings page, as shown in Figure 4-36.

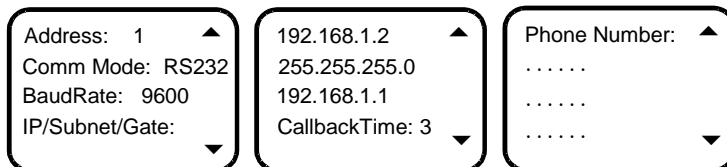

Figure 4-36 Communication Settings page

When the Comm Mode is 'MODEM', the CallbackTime and Phone Number should be set. Use ◀ or ▶ to change the Phone Number or move the cursor left or right. And then press ENT to confirm. The communication parameter settings list is given in Table 4-16.

Table 4-16 Communication parameter settings list

Parameter	Range	Factory setting	Value description
Address	1 ~ 254	1	The addresses of power supply systems that are at the same monitored office should be different
Comm Mode	MODEM	RS232	The system only supports RS232 mode communication MODEM: use the Modem to communicate in telecom protocol
BaudRate	1200bps ~ 9600bps	9600bps	Make sure the baud rates of both the sending and receiving parties are the same
IP/Subnet/Gate	-	-	Set according to actual instance
CallbackTime	-	-	
Phone Number	-	-	

4.8 Setting Energy Saving

The Energy Saving is a sub-menu of the MAINMENU. At the MAINMENU, press ▲ or ▼ to select Energy Saving, then press ENT to confirm. After you input the correct password, the page shown in Figure 4-37 is displayed.

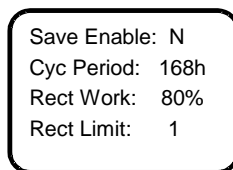

Figure 4-37 Energy Saving page

If you want the system operating under energy saving mode, set 'Save Enable' to 'Y', otherwise, set it to 'N'. Set 'Cyc Period' according to actual instance. The saving operating theory of the system is described as follows:

1. Operating theory

Under energy saving mode, the controller will switch off some rectifiers, the power-on rectifiers will be charged with all loads. Each power-on rectifier works on the best efficiency to improve utilization ratio of the rectifier and save energy consumption. After certain time (that is 'Cyc Period' in Figure 4-37), the power-off rectifiers will work, meanwhile the power-on rectifiers will stop work. Two states circulate, so as to make sure that the working hours of the rectifiers in the system approach. If the battery current and load current change, the controller will switch off some power-on rectifiers or switch on some power-off rectifiers. In any case, the system guarantees at least one rectifier to work.

2. Prerequisite

If the battery is configured and load current without instantly shocks, the system will operate under energy saving mode, that is, 'Save Enable' is set to 'Y'.

3. Advantage

- Working on the best efficiency to save energy.
- Balancing working hours of the rectifiers to prolong the lifetime of the rectifier.
- In shutdown state, preventing rectifiers from damaged about AC inrush to reduce lightning fault.

4. Abnormal situation treatment

- Switch off all the rectifiers when busbar voltage fails (DC over- voltage or low- voltage).
- Switch on all the rectifiers when a rectifier alarm (Rect Not Respond) is generated.
- Switch on all the rectifiers when an AC alarm (Mains Failure) is generated.
- Switch on all the rectifiers automatically when the system has no controller or the communication is interrupted between the rectifier and controller.
- Delay implementation when the rectifier receives shutdown command, immediately execute when the rectifier receives startup order.

The parameters of the energy saving are listed in Table 4-17.

Table 4-17 Energy saving parameters

Parameter	Range	Factory setting	Value description
Save Enable	Y, N	N	It can be set to 'Y' when the battery is configured and load current without instantly shocks
Cyc Period*	1h ~ 8760h	48h	Time of rectifier under power-on state and power-off state, it can be set according to actual requirement
Rect Work	30% ~ 90%	80%	Output capacity percentage. More rectifiers will startup to work when larger than this setting percentage
Rect Limit	1 ~ 30	1	Minimum number of the rectifier
Note*: Cyc Period, Rect Work and Rect Limit are available only when 'Save Enable' is set to 'Y'			

4.9 Fast Settings

The Fast Settings is a sub-menu of the MAINMENU. At the MAINMENU page, press ▲ or ▼ to select Fast Settings, then press ENT to confirm. After you input the correct password, the page shown in Figure 4-38 is displayed.

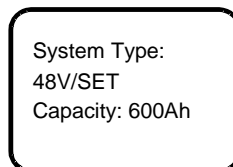

Figure 4-38 Fast Settings page

At the Fast Settings page, you can set the system type and battery capacity, as listed in Table 4-18.

Table 4-18 List of fast settings

Parameter	Range	Factory setting	Value description
System Type	24V/100 24V/300 24V/500 24V/1000 24V/SET 48V/100 48V/300 48V/500 48V/1000 48V/SET	48V/SET	The system type of the controller has been set according to the actual instance before the controller is delivered with power supply system. You need not to change the value except that the controller is replaced with a new one. After changing the type, the controller will restart automatically and the other parameters will resume the default. You need to reset and change some parameters according to the battery and equipment configured with system
Capacity	50Ah ~ 5000Ah	300Ah	The capacity of the total battery strings. You should set this parameter according to the actual battery configuration

Chapter 5 Rectifier

This chapter introduces the R48-2000A3 rectifier on its model description, structure description, functions & features, and technical parameters.

5.1 Model Description

The model description of the rectifier is shown in Figure 5-1.

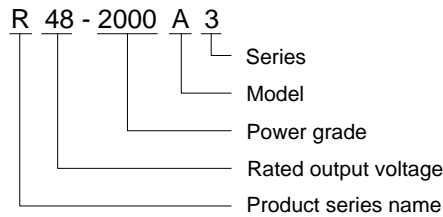

Figure 5-1 Model description

5.2 Structure Description

The rectifier has three indicators on its front panel, as shown in Figure 5-2.

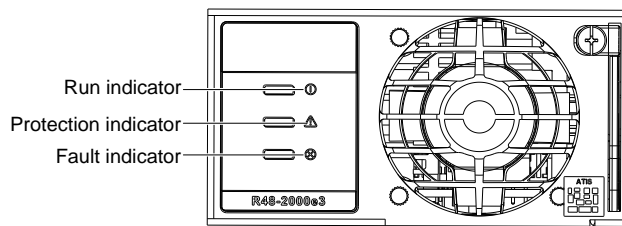

Figure 5-2 Front panel of the rectifier

The functions of the indicators are given in Table 5-1.

Table 5-1 Functions of indicators

Indicators	Color	Normal state	Fault state	Fault reason
Power indicator	Green	On	Off	There is no input and output power supply
			Blinking	The background makes operation to the rectifier
Protection indicator	Yellow	Off	On	AC input over/under voltage, rectifier PFC output over/under voltage, over temperature. Unevenload sharing of the rectifier
			Blinking	The rectifier communication is interrupted
Fault indicator	Red	Off	On	Output over voltage, rectifier output fuse blown, conflict of rectifier address
			Blinking	The rectifier fan is faulty

The input and output of the rectifier connect with the rear panel of the rectifier through the gold finger. The rear panel of the rectifier is shown in Figure 5-3. The functions of the pins are listed in Table 5-2.

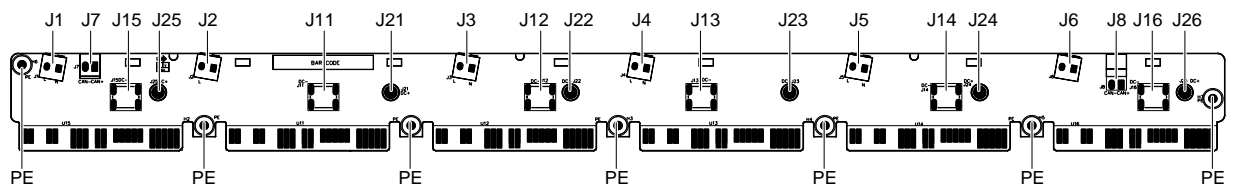

Figure 5-3 Rear panel of the rectifier

Table 5-2 Pin function

Socket	Pin	Function
AC input socket	J1	Rectifier 1 AC input
	J2	Rectifier 2 AC input
	J3	Rectifier 3 AC input
	J4	Rectifier 4 AC input
	J5	Rectifier 5 AC input
	J6	Rectifier 6 AC input
	PE	Rectifier AC earthing
DC output socket	J11 ~ J16	DC output -
	J21 ~ J26	DC output +
	J7	CAN/ matched resistance
	J8	Matched resistance /CAN

5.3 Functions & Features

1. Hot plugging

The rectifier uses hot plugging technology. There is soft-start unit in the input end and output end of the rectifier. When the rectifier is inserted into the power supply system, the output voltage of the power supply system will not be disturbed. It takes less than one minute to replace the rectifier.

2. Digital load-sharing

The rectifier uses advanced digital load-sharing technology. There is no need to share the loads through the controller, they can automatically share the loads between the rectifiers. The imbalance degree of the load-sharing is less than $\pm 3\%$.

3. Input power limiting

Based on the change of the input voltage, the rectifier uses advanced power limiting method. The change point is 215V (the return difference is less than 3V). When the input voltage is within 154Vac ~ 300Vac, the rectifier can output the maximal power.

4. Temperature limiting power

In the normal input status of the rectifier, the rectifier can work normally and output the maximum power (1740W) under the temperature of $-40^{\circ}\text{C} \sim +45^{\circ}\text{C}$.

5. Fan control

When the input voltage of the rectifier is within the normal range, the rotation speed of the fan will increase with the rise of the rectifier internal temperature until the fan runs at full speed.

When the AC input is too high or too low, the fan will stop running.

5.4 Fault Protection

1. Input over/under-voltage protection

When the input voltage is lower than $80\text{Vac} \pm 5\text{Vac}$ or higher than $305\text{Vac} \pm 5\text{Vac}$, the protection indicator (yellow) illuminates, the rectifier will shut down and stop output. When the input voltage returns to the normal range of $95\text{Vac} \sim 295\text{Vac}$, the rectifier will resume work automatically.

When an over-voltage protection event occurs, the rectifier will report it to the controller.

2. Output over-voltage protection

The rectifier has two optional over-voltage protection methods: hardware protection and software protection.

The hardware over-voltage protection point is $58.5\text{V} \sim 60\text{V}$. After the hardware over voltage protection occurs, it requires manual resetting to restore operation.

The software over-voltage protection point can be set by the controller, the setting range is $56\text{V} \sim 59\text{V}$, which must be at least 0.5Vdc higher than the output voltage. The factory default setting is 59V .

The software over-voltage protection mode can be selected by the controller.

1) Lock out at the first over-voltage

When the rectifier encounters software over-voltage, the rectifier will shut down and stay off. It can only be started manually.

2) Lock out at the second over-voltage

After the rectifier software over-voltage protection occurs, the rectifier will restart automatically within five seconds after shutdown. If a second over-voltage occurs within the set time (five minutes by default, it can be set by the controller), the rectifier will shut down and stay off. It can only be started manually.

Manual startup:

- Restore the rectifier by the controller.
- Restore the rectifier by releasing the rectifier from the power supply system.

3. Over-temperature protection

The temperature control switch on the rectifier monitors the temperature of the power conversion circuit. When the temperature of the power conversion circuit exceeds the set upper value of +85°C, the rectifier will stop working. When the temperature drops to or under the safety value of +82°C, the rectifier will work automatically.

4. Short circuit protection

When the short circuit fault occurs, the rectifier uses the constant current output. The current is not bigger than 55A. When the fault is cleared, the rectifier will restore operation automatically.

5. Fan failure protection

When a fan fails, the rectifier will generate a fan failure alarm, the fault indicator (red) on the rectifier panel will blink, the rectifier shuts down and stops output. After the fault is cleared, the rectifier can resume normal operation automatically.

When a fault occurs, the rectifier will report it to the controller for corresponding handling.

6. Imbalanced output current

The rectifier imbalanced output current means that the average current of the rectifier is bigger than 6A (20% of rated current), and the error between the rectifier current and the average current is bigger 4.8A (16% of rated current). In this point, the protection indicator (yellow) turns on.

When the load current of the rectifier on the power supply system is less than 0.6A (2% of rated current), and the average load current of the rectifier is not less than 6A (20% of rated current), the serious imbalanced output current fault occurs, the fault indicator (red) turns on. After the fault is cleared, the rectifier can restore operation automatically or manually, and the fault indicator (red) will turn off.

When the failure event occurs, the rectifier will report the alarm signal to the controller for corresponding handling.

7. Communication interrupted

When a communication failure occurs to the rectifier, the protection indicator (yellow) on the rectifier panel blinks. When the communication recovers, the rectifier will resume normal operation automatically, and the protection indicator (yellow) also resumes normal operation.

To protect the battery, the rectifier output voltage becomes 53.5V (default value, which can be set by the controller) after the communication failure occurs.

8. Power factor correction equipment fault

If the power factor correction equipment fails, that is, the voltage is bigger or lower than the internal DC busbar voltage, the rectifier will shut down, and the protection indicator (yellow) turns on. When the rectifier restores operation automatically, the protection indicator (yellow) turns off.

9. DC/DC converter fault

If the DC/DC converter fails, and results in HVSD or serious imbalanced current, the rectifier will shut down, the fault indicator (red) turns on. After the fault is cleared, the rectifier will resume operation automatically or manually, and the fault indicator (red) turns off. If the serious imbalanced current is generated, and the system average load current is bigger than the 10% of the rated current (the rated current is 30A), the fault indicator (red) turns on.

5.5 Technical Parameters

The technical parameters of the rectifier are listed in Table 5-3.

Table 5-3 Technical parameters of the rectifier

Parameter type	Parameter name	Value	
Ambient conditions	Operating temperature	-40°C ~ +75°C	
	Storage temperature	-40°C ~ +70°C	
	Relative humidity	≤ 90%RH, non-condensing	
	Altitude	0 ~ 2000m (detating is needed above 2000m)	
	Cooling mode	Forced air cooling	
AC input	Input voltage standard	Single-phase, 3-line	
	Input voltage range	85Vac ~ 300Vac	
	Rated input voltage	200Vac ~ 250Vac	
	Input voltage range in power derating	85Vac ~ 154Vac	
	Max. static voltage in non-working condition	415Vac	
	Max. input current	< 13A	
	Allowable input grid frequency	45Hz ~ 65Hz	
	Rated input grid frequency	50Hz/60Hz	
DC output	DC output voltage range	42V ~ 58V	
	Output DC current	0 ~ 36.25A	
	Total regulation	≤ ±0.5%	
	Load regulation	≤ ±0.5%	
	Voltage regulation	≤ ±0.1%	
	Surge current in startup	≤ 20A	
	Output limiting character	Stepless current limiting	
Power factors and THD	Power factors	> 0.98	
		> 0.99	
		> 0.99	
THD	< 5%		
Noise index	Peak-peak noise	Reference standard: YD/T7314.4.3.4	
	Phone sophomorically weighted noise	Reference standard: YD/T731-2002 4.4.3.1	
	Wide frequency noise	Reference standard: YD/T731_2002 4.4.3.2	
	Discrete noise	Reference standard: YD/T731 4.4.3.3	
		Reference standard: YD/T731 4.4.3.3	
		Reference standard: YD/T731 4.4.3.3	
Reference standard: YD/T731 4.4.3.3			
EMC index	Surge	Reference standard: EN61000-4-5	
	EFT	Reference standard: EN 61000-4-4	
	ESD	Reference standard: EN 61000-4-2	
	Immunity to continuous conducted interference	Reference standard: EN 61000-4-6	
	Immunity to radiated electric fields	Reference standard: EN 61000-4-3	
	Immunity to voltage dip, interrupted and slowness change	Reference standard: EN 61000-4-11	
	Input Harmonic current emission	Reference standard: EN61000-3-2	
	Immunity to power frequency magnetic field	Reference standard: EN 61000-4-8	
	Input voltage fluctuation and flash	Reference standard: EN61000-3-3	
	Conducted emission	Class A (DC side)	Reference standard: EN300386:2012
		Class A (DC side)	Reference standard: EN55022
		Class A (AC side)	Reference standard: EN55022
	Radiated emission	Class A	

Parameter type	Parameter name	Value
Safety	Safety	UL/EN/IEC60950
Protection characteristics	Over/under-voltage protection	Input under-voltage protection point: 80V ± 5V
		Input over-voltage protection point: 305V ± 5V
		Output over-voltage hardware protection point: 58.5V ~ 60V
	Output over-voltage software protection point: 56V ~ 59V (it can be configured through the controller)	
Over-temperature protection	The rectifier will shut down, owing to over-temperature	
Mechanical parameters	Size (Height × Width × Depth)	43.6mm × 85.1mm × 252.5mm
	Weight	≤ 2.0kg
Others	Efficiency	> 95.5% (peak value)
	Current sharing	The current sharing error of the rectifier is smaller than ±0.9A
	Temperature coefficient (1/°C)	0.01%
	Dynamic response	Response time: ≤ 200µs; Overshoot: ≤ 5%
	Start-up time (select the startup mode through the controller)	Normal startup: the time delay from AC power-up to rectifier output is less than 5s
		Gradual onset of output: The start-up time can be set through the controller. The settable range is 8s ~ 124s, and the precision is not bigger than ±10%
	Noise	≤ 50dB (A)
	Surge protection	EN61000-4-5
	Cooling method	The fan uses the the stepless temperature control to adjust the fan speed. The speed increases with the rise of the temperature
	Insulation resistance	Apply a test voltage of 500Vdc. The insulation resistances between DC circuit and earth, AC circuit and earth, and AC and DC circuits are all not less than 5MΩ
	Insulation strength	AC input terminal to enclosure: 2121Vdc. AC input terminal to DC output terminal: 4242Vdc. DC output terminal to enclosure: 707Vdc. For all the three tests above, there should be no breakdown within 1min, with steady state leakage current no bigger than 1mA
MTBF	≥ 120000 hours	

Chapter 6 Alarm Handling

This chapter describes the handling of alarms, as well as the preventive maintenance of the system during system daily operation.

The maintenance personnel must have adequate knowledge about the power system.

Note

1. The maintenance must be conducted under the guidance of related safety regulations.
2. Only the trained personnel with adequate knowledge about the power system can maintain the inner part of the cabinet.

6.1 Handling Alarms

The controller alarms are classified in four types: critical alarm, major alarm, observation and no alarm.

Critical alarm, major alarm: these two types of alarms have strong impacts on the system performance. Whenever these alarms are generated, users are supposed to handle them immediately. The alarm indicators will be on and audible indication will be given.

Observation: when this type of alarm is raised, the system maintains normal output for a while. If the alarm occurs during watch time, it should be handled immediately. If the alarm occurs during non-watch-time, handle it during watch time. The alarm indicators will be on when observation alarm occurs.

No alarm: if alarms are set as 'no alarm' by the users, when these alarms occur, no visible or audible indication will be generated and the system works normally.

The handling methods of normal alarms are given in Table 6-1.

Table 6-1 System setting parameter description

No.	Alarm	Handling method
1	Mains Failure	If the failure does not last long, the battery will power the load. If the cause is unknown or the failure lasts too long, a diesel generator is needed. Before using the generator's power, it is suggested to run the generator 5 minutes to stabilize the power output
2	AC Voltage High	Check if the AC Over-voltage point is too low. Reset the value if too low A mild over-voltage does not affect the system operation. However, the rectifier will stop operation when the mains voltage is more than 305V. Therefore, if the power supply is constantly over-voltage, the mains power network should be improved
3	AC Voltage Low	Check if the AC Under-voltage point is too high. Reset the value if too high When the mains voltage is lower than 176V, the output power of the rectifiers will be derated. The rectifier will stop working if the mains voltage is lower than 80V. If the power supply is constantly under-voltage, the main power network should be improved
4	DC Volt High	1. Check the system DC output voltage and value of 'Over' set on the controller. If the set value is improper, correct it. 2. Find out the rectifier that has caused the alarm. First of all, ensure that the batteries can operate normally. Then switch off the AC input MCBs of all rectifiers. Power on the rectifiers one by one. If the over-voltage protection is triggered when a certain rectifier is powered on, that rectifier is the faulty one. Replace the fault rectifier
5	DC Volt Low	1. Check the system DC output voltage and value of 'Under' set on the controller. If the set value is improper, correct it 2. If the alarm is caused by mains failure, check if certain loads can be disconnected to prolong the operation of the whole system 3. If the alarm is due to rectifier fault, find out the faulty rectifier and replace it 4. Compare the total load current with the rectifier current, and the former should not be bigger than the later at FC voltage, otherwise partial loads must be disconnected to ensure the safe operation of the whole system. Add several rectifiers to make the total rectifier current bigger than 120% of the total load current. In addition, there must be at least one rectifier for redundancy standby
6	Load Fuse Alarm/ Batt Fuse Alarm	Check if the MCB or fuse of the route is switched off. If the MCB is open, find out the fault and remove it. Or check the voltage at the alarm fuse. If the voltage is almost 0V, the fuse is normal Otherwise, the alarm loop is faulty. Please contact Vertiv

No.	Alarm	Handling method
7	LVD2	1. Check if there is mains failure, or the battery voltage is lower than the 'BLVD' value, or the battery discharge time is more than the 'BLVD Time' 2. The battery is disconnected from the system manually
8	Rect Failure	The red LED on the rectifier will turn on 1. Reset the rectifier by powering it off and then on again 2. If the rectifier still causes this alarm, replace it
9	Rect Protect	Check if the mains is outside the range of 80V ~ 305V (between the AC under-voltage point and over-voltage point) If the power supply is constantly over/under-voltage, the mains power network should be improved
10	Rect Fan Fails	1. Check whether the rectifier fan is still working. 2. If the fan stands still, pull out the rectifier to check whether the fan is blocked or not. If yes, clean it and push the rectifier back. However, if the fan still does not move after the rectifier is powered on, replace it (see <i>Replacing rectifier fan</i> of 6.2 <i>Handling Rectifier Fault</i>)
11	Rect Not Respond	Check if the communication between rectifier and controller fails. If the communication is normal, reset the rectifier by pulling it out and pushing back in. If the alarm persists, replace the rectifier
12	Batt Over Temp	1. Check if there is battery internal fault. If yes, replace the fault battery 2. Check if the battery room temperature is too high. If yes, cool down the battery room

6.2 Handling Rectifier Fault

Fault estimation

The symptoms of usual rectifier faults include: green indicator (run indicator) off, yellow indicator (protection indicator) on, yellow indicator blink, red indicator (fault indicator) on and red indicator blink.

The indicators are shown in Figure 6-1 and the indicator descriptions are given in Table 6-2.

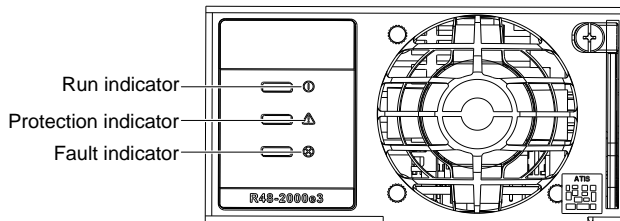

Figure 6-1 Rectifier indicator

Table 6-2 Indicator fault description

Symptom	Controller alarms	Causes	Handling method	
Run indicator off	No alarm	No input/output voltage	Make sure there is input/output voltage	
		Assistant power source of the rectifier fails	Replace the recitifier	
Run indicator blinks	No alarm	The controller performs operations upon the rectifier		
Yellow indicator on	Rect Over Temp	AC input voltage abnormal	Make sure the AC input voltage is normal	
		Over-temperature protection due to:	Fan blocked	Remove the object that blocks the fan
			Ventilation path blocked at the inlet or vent	Remove the object at the inlet or vent
	Ambient temperature too high or the inlet close to a heat source	Decrease the ambient temperature or remove the heat source		
	Rect Protect	Current sharing imbalance	Check whether the rectifier communication is normal. If not, check whether the communication cable is in normal connection. If the communication is normal while the yellow indicator is on, replace the rectifier	
		Power factor compensation (PFC) internal under-voltage or over-voltage	Change the fault rectifier position with the normal rectifier. If the fault rectifier cannot work still, replace the rectifier	
		AC input voltage exceeds the normal range	Make sure the AC input voltage is within the normal range	

Symptom	Controller alarms	Causes	Handling method
Yellow indicator blinks	Rect Not Respond	Rectifier communication interrupted	Check whether the communication cable is in normal connection
Red indicator on	Rect Failure	Rectifier over-voltage	Reset the rectifier. If the protection is triggered again, replace the rectifier
		Two or more rectifiers have the same ID number	Contact Vertiv for maintenance
	System current imbalance	Serious current sharing imbalance (When the rectifier current is larger than 3.5A, the current imbalance between the rectifiers is larger than $\pm 1.2A$)	Check whether the rectifier communication is normal. If not, check whether the communication cable is in normal connection. If the communication is normal while the red indicator is on, replace the rectifier
Red indicator blinks	Rect Fan Fails	Fan fault	Replace the fan

Replacing rectifier fan

Abide by the following to replace the fan, when the rectifier fan fails:

- Performing this procedure may activate external system alarms. Do one of the following.
 - If possible, disable these alarms.
 - If these alarms cannot be easily disabled, notify the appropriate personnel to disregard any alarms associated with this system.
- Refer to *Replacing rectifier* in the following section to remove the rectifier from the rack.
- Place the rectifier on a static-safe work surface. Connect an approved ESD wrist-strap to your wrist.
- As shown in Figure 6-2, loosen the two screws of the rectifier to remove the panel.
- Pull out the fan of the rectifier carefully until the fan power cables can be touched.
- Take off the fan power cables from the PCB board, and remove the fan.
- Plug the power cable of the new fan into the connector on the PC board.
- Place the fan in its cavity in the rectifier, and make sure that the airflow direction of the fan points toward the rear of the rectifier.
- Reinstall the panel on the rectifier. Ensure that no fan cable is pinched. Secure panel with the two removed screws.
- Reinstall the rectifier into the rack according to 2.3.2 *Installing Rectifier*.
- When the fans start, check to ensure that the fan airflow is directed from front to back. If airflow direction is wrong, immediately remove the rectifier from the rack. Repeat preceding steps to check fan orientation, and correct as necessary. Reinstall the rectifier and again check for proper airflow.
- Enable the external alarms, or notify appropriate personnel that this procedure is finished.
- Ensure that there are no local or remote alarms active on the system.

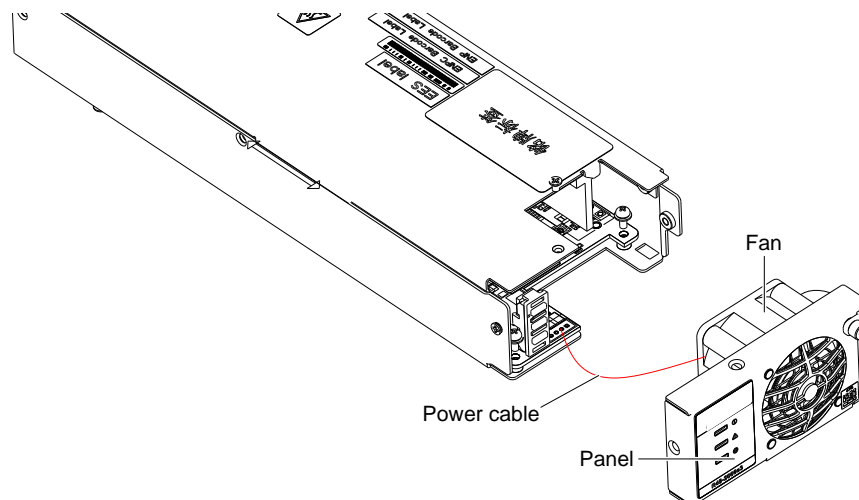

Figure 6-2 Rectifier fan Replacement

Replacing rectifier

1. Take a new rectifier and check it for any damage.
2. Loosen the fixing screw of the handle of the rectifier.
3. Pull the fixing screw of the handle with hand to pull out the handle, and then pull out the faulty rectifier from the rack by grabbing its handle.

Be careful with the rectifier just pulled out from the system, as it could be very hot due to long-term operation. Do not let it slip away and get damaged.

4. Holding the new rectifier handle, push the new rectifier into the slot and make sure the connection is good.

After a brief delay, the rectifier RUN indicator will turn on and the fan will start running.

5. Check that the new rectifier works normally.

You should make sure that:

- 1) The controller recognizes the new rectifier.
- 2) The new rectifier shares current with other rectifiers.
- 3) When this new rectifier is pulled out, there is a corresponding alarm and the controller displays the alarm.

If the new rectifier passes all the above tests, the replacement is a success.

6. Push the handle back into the front panel to lock the rectifier.
7. Fix the fixing screw of the handle of the rectifier.

6.3 Handling Controller Fault

Fault estimation

The fault phenomena of the controller are LCD failure or displayed contents incorrect. Users should take the following procedures to estimate fault causes:

1. Remove the fixing screws of the cover plate of the PCB board.
2. Estimate fault causes according to the indicator status of the PCB board, as listed in Table 6-3.

Table 6-3 controller fault causes and handling methods

Phenomenon	Fault cause	Handling method
Watchdog indicator and power indicator off	PCB board has no auxiliary power supply	Check if J421 terminal is connected reliably. If the connection is reliable and the terminal voltage is normal (approximately the busbar voltage of the power supply system), the PCB board is faulty, replace it
Watchdog indicator on or off, power indicator on	Software not running	Replace the PCB board
Watchdog indicator flashing, LCD display incorrect	Signal cable incorrect connection or PCB board faulty	Check if the signal cable connection is correct and reliable. If not, reconnect it. If yes, the PCB board is faulty and needs replacement
Watchdog indicator flashing, LCD no display	PCB board faulty or LCD faulty	Replace the LCD according to the next section <i>Replacing LCD</i> . check if the LCD displays normally. If yes, the fault handling is over. If not, the PCB board is faulty, replace it
Power indicator on, watchdog indicator on or off, Lcd displays 'Bootloader is Running'	The program enters firmware upgrade interface	Wait about 5min, the controller will switch back to the main program automatically. If it fails to switch after 5min, the application program fails to program, or the application program is damaged. At this point, you need to program the applicable program again. If it still fails, the CPU is damaged

The indicators and terminals of the PCB board are shown in Figure 6-3.

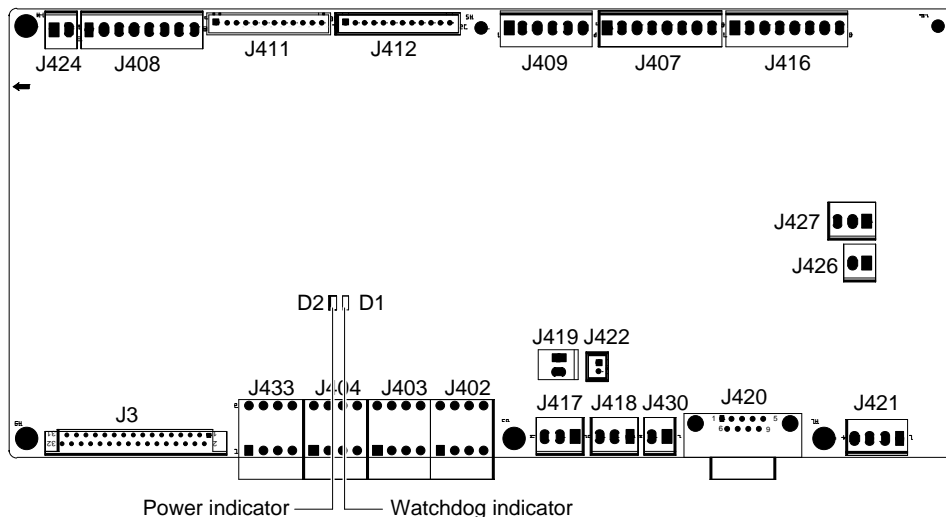

Figure 6-3 Indicators and terminals of the PCB board

Replacing PCB board

Note

Care should be taken when replacing components of the controller. Unplugging terminals optionally may result in system shut down. Carry out the replacement sequentially according to the following procedures.

1. Unplug J426, J427 and J421 terminals to prevent shutting down of the power supply system.
2. Unplug the J421 power supply terminal to power off the PCB board.
3. Unplug other terminals and DI/DO cables.
4. Wrap the DI/DO cable terminals with insulating tape. Keep the unconnected terminals and cables insulate from components of the power supply system and the PCB board to prevent short circuit.
5. Remove the fixing screws of the PCB board and replace the PCB board. Note that the screwdriver should be prevented from touching the bare parts of the signal cables to prevent short circuit.
6. Connect the signal cables in reverse sequence, that is, reconnect signal cables other than J421, J426, J427 terminal cables and DI/DO cables.
7. Check the cable connections. If the connections are correct, reconnect J421 terminal. If the watchdog indicator blinks and the power indicator is on, the PCB board works normally.
8. Check the voltages of J426 and J427 terminals with a multimeter. Make sure that they output low voltage. Connect J426 and J427 terminals.
9. Set the parameters of the controller according to 4.7 *Setting*.

Replacing LCD

The procedures of replacing LCD are described as follows:

1. Unplug J426, J427 and J421 terminals of the PCB board.
2. Unplug the J3 terminal tape cable connected to the LCD.
3. Replace the LCD. Restore the J3 terminal tape cable. Pay attention not to short the LCD with the power supply system or the LCD with the PCB board.
4. Connect J421 terminal.
5. Check the voltages of J426 and J427 terminals with a multimeter. Make sure that they output low voltage.
6. Connect J426 and J427 terminals. The replacement is complete.

Appendix 1 Technical Parameter

Table 1 Technical data

Parameter category	Parameter	Description
Environmental	Operating temperature	-5°C ~ +40°C
	Storage temperature	-40°C ~ +70°C
	Relative humidity	5%RH ~ 90%RH
	Altitude	≤ 2000m (derating is necessary above 2000m)
	Others	No conductive dust or erosive gases. No danger of explosion
AC input	Input voltage	220Vac ~ 240Vac
	Input voltage range	85Vac ~ 300Vac
	Input AC voltage frequency	45Hz ~ 65Hz
	Max input current	50A (when the AC output is present in the user end)
	Power factor	≥ 0.99
DC output	Rated output voltage	-53.5Vdc
	Output DC voltage	-42.3Vdc ~ -57.6Vdc
	Output DC current	Max. output current ≥ 360A, max. load current: 300A
	Voltage set-point accuracy	≤ ±1%
	Efficiency	≥ 93.5%
	Noise (peak-peak)	≤ 200mV
	Weighted noise	≤ 2mV
AC input alarm and protection	AC input over-voltage alarm point	Default: 280Vac ± 5Vac, configurable through controller
	AC input over-voltage alarm recovery point	Default: 270Vac ± 5Vac, 10Vac lower than the AC input over-voltage alarm point
	AC input over-voltage protection point	Default: 305Vac ± 5Vac, configurable through controller
	AC input over-voltage protection recovery point	10Vac ~ 20Vac lower than the AC input over-voltage protection point
	AC input under-voltage alarm point	Default: 180Vac ± 5Vac, configurable through controller
	AC input under-voltage alarm recovery point	Default: 190Vac ± 5Vac, 10Vac higher than the AC input under-voltage alarm point
	AC input under-voltage protection point	Default: 80Vac ± 5Vac, configurable through controller
	AC input under-voltage protection recovery point	10Vac ~ 20Vac higher than the AC input under-voltage protection point
DC output alarm and protection	DC output over-voltage alarm point	Default: 58.5Vdc ± 0.2Vdc, configurable through controller
	DC output over-voltage recovery point	Default: 58.0Vdc ± 0.2Vdc, 0.5Vdc lower than the over-voltage alarm point
	DC output under-voltage alarm point	Default: 45.0Vdc ± 0.2Vdc, configurable through controller
	DC output under-voltage recovery point	Default: 45.5Vdc ± 0.2Vdc, 0.5Vdc higher than the under-voltage alarm point
	BLVD	Default: 43.2Vdc ± 0.2Vdc, configurable through controller
Rectifier	Current sharing	The rectifiers can work in parallel and share the current. The imbalance is better than ±3% rated output current. Test current range: 10% ~ 100% rated current
	Derate by input (45°C)	The max. output power of the rectifier is 100% rated power (1740W) with input voltage of 176Vac ~ 290Vac
	Output delay	Output voltage can rise slowly upon rectifier start up. The rise time is configurable
	Fan speed adjustable	Rectifier fan speed can be set to auto or full speed

Parameter category	Parameter	Description	
Rectifier	Over-voltage protection	The rectifier has two optional over-voltage protection methods: hardware protection and software protection. The hardware over-voltage protection point is 59.5Vdc \pm 0.5Vdc, and it requires manual resetting to restore operation. The software over-voltage protection point can be set by the controller, the setting range is 56V ~ 59V, which must be at least 0.5Vdc higher than the output voltage. The factory default setting is 59Vdc	
	Temperature derating	Temperature between -20°C ~ +45°C, outputs full power: 1740W	
EMC	Conducted emission (CE)	Class A EN55022	
	Radiated emission (RE)		
	Immunity to EFT	Level 3 EN61000-4-4	
	Immunity to ESD	Level 3 EN61000-4-2	
	Immunity to Surges	Level 4 EN61000-4-5	
Others	Safety	IEC60950	
	Surge protection	The AC input side can withstand five times of simulated lightning surge current of 20kA at 8/20 μ s, for the positive and negative polarities respectively. The test interval is not smaller than 1min. It can also withstand one event of simulated lightning surge current of 40kA at 8/20 μ s	
	Acoustic noise	\leq 60dB(A) (When the ambient temperature is lower than 25°C)	
	Insulation resistance	At temperature of 25°C \pm 5°C and relative humidity not bigger than 90%RH, apply a test voltage of 500Vdc. The insulation resistances between AC circuit and earth, DC circuit and earth, and AC and DC circuits are all not less than 10M Ω	
	Insulation strength	AC to DC circuits: 50Hz, 3000Vac (RMS). AC circuit to earth: 50Hz, 2500Vac (RMS). DC circuit to earth: 50Hz, 1000Vac (RMS). Assistant circuit (not directly connected to the host circuit): 50Hz, 500Vac (RMS). For all the tests above, there should be no breakdown or flashover within 1min, with leakage current not bigger than 10mA	
	MTBF	200000h	
	ROHS	Compliant with R5 standard	
Mechanical	Size (W xD xH) (mm)	Cabinet	NetSure 531 AC1-Y1, NetSure 531 AC1-Y6: 600 x 600 x 2000 NetSure 531 AC1-W6: 600 x 500 x 400
		Rectifier	85.1 x 252.5 x 43.6
		Battery compartment	540 x 545 x 350 (accommodating 4 x 165Ah battery) 540 x 545 x 280 (accommodating 4 x 100Ah battery)
	Weight (kg)	Cabinet (excluding rectifiers, controller and batteries)	\leq 140
		Rectifier	\leq 2.0

Appendix 2 Engineering Diagram

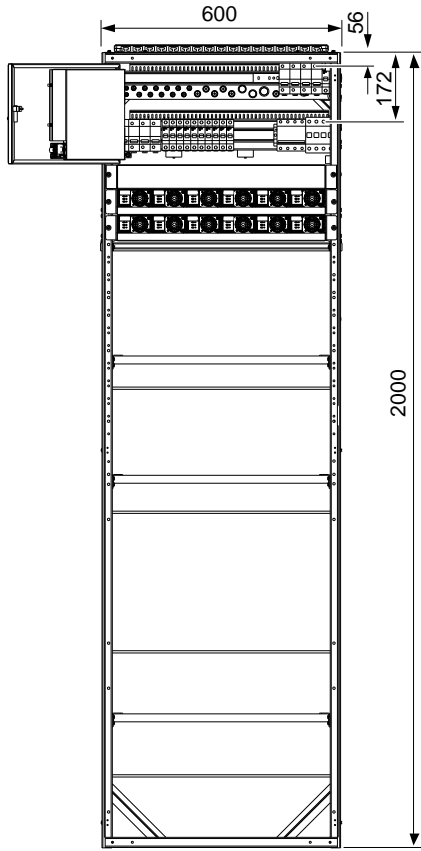

Figure 1 Engineering diagram of NetSure 531 AC1-Y1 (unit: mm)

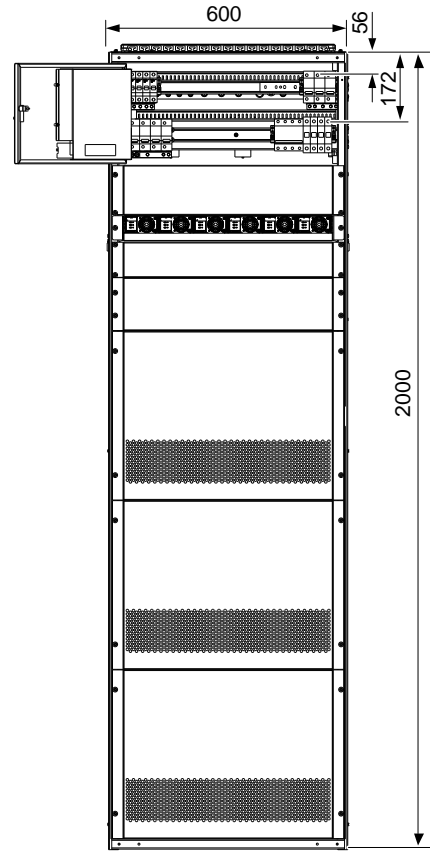

Figure 2 Engineering diagram of NetSure 531 AC1-Y6 (unit: mm)

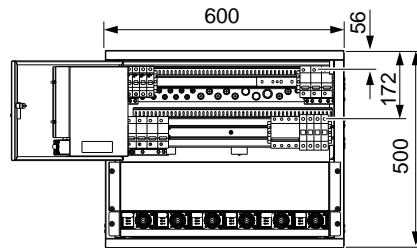

Figure 3 Engineering diagram of NetSure 531 AC1-W6 (unit: mm)

Appendix 3 Parameter Setting Of The Controller

This chapter gives the description of the controller parameter setting. The detailed information and operating method are given in *Chapter 4 Use Of Controller*. Refer to 4.7.1 *Alarm Settings* for the alarm setting.

Table 2 Parameter setting of the controller

Item	Parameter	Range	Factory setting	Value description		
Alarm	DI No.	1 ~ 8	1	Correspond with eight connection terminals, and arrange in terminal No. aequence		
	DI Name	-	SPD	Figures or letters, 10 at most		
	Alarm Mode	High, Low	Low	Alarm upon high level or upon low level		
Battery	Basic	Sys Mode	Auto, Manual	Auto	Managing the system through the controller or manually	
		Bat. Fuse	0 ~ 4	4	Set according to the actual battery configuration	
		Capacity	50Ah ~ 5000Ah	300Ah	The capacity of the each battery strings. You should set this parameter according to the actual battery configuration	
		Bat. Shunt1	Y, N	Y	You can set this parameters only when 'System Type' is 'SET'	
		Bat. Shunt2		N		
		Shunt Coeff Current	1A ~ 5000A	NetSure 531 AC1-Y1: 300A; NetSure 531 AC1-Y6, NetSure 531 AC1-W6: 150A		
	Shunt Coeff Volt	1mV ~ 500mV	25mV			
	LVD	LVD1 Enable	Y, N	Y		Select 'Y' to enable LVD1/ LVD2 function
		LVD2 Enable		Y		Select 'N' to disable the LVD1/ LVD2 function
		LVD1 Volt	40V ~	44.0V	Taking the battery voltage as standard, when the battery voltage drops to the set value, the loads and the batteries will be disconnected	
		LVD2 Volt	60V	43.2V		
	Charge management	Float	42V ~	53.5V	Battery float charging voltage	
		Boost		58V	56.4V	Battery boost charging voltage. The 'Boost' must be higher than the 'Float'
		Limit (current limit point)	0.1C ₁₀ ~ 0.25C ₁₀	0.1C ₁₀	Maximum battery charging current	
		Over (over current point)	0.3C ₁₀ ~ 1.0C ₁₀	0.300C ₁₀	Battery charge over-current alarm point	
Auto Boost Enable		Y, N	Y	Select 'Y' to enable this function Select 'N' to disable this function		
Auto Boost Current		0.050C ₁₀ ~ 0.080C ₁₀	0.06C ₁₀	If the Automatic Boost function is enabled, the controller will control the system enter the BC state when the battery capacity decreases to the set value of Auto Boost Cap, or when the charge current reaches the Auto Boost Current. The charge voltage will be the set valut of Boost		
Auto Boost Cap		10% ~ 99%	80%			
Const Boost Current		0.002C ₁₀ ~ 0.02C ₁₀	0.01C ₁₀	When the charge current decreases to the set value of Const Boost Current, the system in the BC state will still be in BC state for some time set in Const Boost Time. After that, the system in the BC state will enter the FC state		
Const Boost Time		30min ~ 1440min	180min			
Cyc Boost Enable		Y, N	Y	Select 'Y' to enable this function Select 'N' to disable this function		
Cyc Boost Period	48h ~ 8760h	2400h	'Cyc Boost Period' indicates the time interval between twice boost charge. The battery charging voltage is the preset Boost, and the charging time is the preset Cyclic Boost Time			
Cyc Boost Time	30min ~ 2880min	720min				

Item	Parameter	Range	Factory setting	Value description	
Battery	Charge management	Boost Limit Time	60min ~ 2880min	1080min	To ensure safety, the controller will forcefully control the power supply system to enter the FC state during the BC state when the BC time reaches the preset Boost Limit Time
	Battery test	End Test Volt	43.1V ~ 57.9V	45.2V	The controller will stop the test if the battery voltage reaches the End Test Volt, or the discharge time reaches End Test Time, or the battery capacity reaches End Test Cap
		End Test Time	5min ~ 1440min	300min	
		End Test Cap	0.01C ₁₀ ~ 0.95C ₁₀	0.7C ₁₀	
		Cyc Test En	Y, N	Y	Select 'Y' to enable this function Select 'N' to disable this function
		Cyc Test Time 1	Month, day, time	01-01-00:00	When the parameter Cyc Test En is set to Y, the power supply system will test the battery in this set time
				04-01-00:00	
				07-01-00:00	
				10-01-00:00	
		Short Test Enable	Y, N	N	Whether using Short Test function
		Short Test Alarm	1A ~ 100A	10A	If the battery is not discharged within the set time of Short Test Period, the controller will start a short test, whose operation time is set by the parameter Short Test Time. By the end of the test, if the difference between the discharge current of two battery strings is bigger than the Short Test Alarm, the 'Short Test Abnormal' alarm will be raised
		Short Test Period	24h ~ 8760h	720h	
		Short Test Time	1min ~ 60min	5min	
		Stable Test Enable	Y, N	N	Whether using Stable Test function
	Stable Test Current	0 ~ 9999A	9999A	Battery discharging current under stable test	
	Temperature coefficient	Center Temp	10°C ~ 40°C	25°C	FC = (BattTemp – Center Temp) × Temp Coeff Upon alarms such as Rect Not Respond, DC Volt High, DC Volt Low and Batt Fuse Alarm, the controller will not do temperature compensation to the battery FC voltage
		Coeff	0 ~ 500mV/°C	72mV/°C	
		Temp1	Ambient Temp, None, Battery Temp	None	Measurement of ambient temperature, battery temperature, non measurement
		Temp2			
		Batt T H2	-40°C ~ 100°C	50°C	When the detected battery temperature is higher than the set value, the controller will raise an alarm. The Batt T H1 must not be higher than the Batt T H2
Batt T H1		-40°C ~ 100°C	50°C		
Batt T L1		-40°C ~ 100°C	0°C	When the detected battery temperature is lower than the set value, the controller will raise an alarm	
AC	Over Volt	50V ~ 300V	280V	System AC input over-coltage alarm point	
	Low Volt	50V ~ 300V	180V	System AC under-voltage alarm point. The value must be lower than the set value of Over Volt	
	Under Volt	50V ~ 300V	80V	Setting according to actual requirement	
	AC In	Auto, No, Manual	No	Setting according to the AC input mode of AC sampling board. Choose 'No' if the AC sampling board is not configured	
	AC PH	1-PH, 3-PH	3-PH	Setting according to the actual configuration. Choose '1-PH' and '3-PH' if the AC sampling board is configured	
DC	Over Volt	40V ~ 60V	58.5V	DC over-voltage alarm point	
	Low Volt 1		45.0V	DC low-voltage alarm point, must be lower than DC over-voltage alarm point	
	Low Volt 2		45.0V	DC under-voltage alarm point, must be lower than DC low-voltage alarm point	
	L-Shunt En	Y, N	N	Setting according to the actual instance	

Item	Parameter	Range	Factory setting	Value description
DC	Shunt Coeff Current	1A ~ 5000A	-	They can be reset when the shunt options are 'SET' in the system with load shunt
	Shunt Coeff Volt	1mV ~ 500mV	-	
Rectifier	Position En	Y, N	Y	'Y': The controller will prompt you to set rectifier position before the rectifier and controller are powered on. 'N': You need not to set rectifier position
	R-Posi	1 ~ 30	-	R-Posi: represented in two figures, the first figure represents the rectifier number, the next figure represents position number. Press ENT to select the rectifier, press ◀ or ▶ to change position number. When the controller communicates with the rectifier, the green indicator on the corresponding rectifier will blink
	HVSD	56V ~ 59V	59V	Rectifier over-voltage alarm point
	Default V	48V ~ 58V	53.5V	Default output voltage when communication interrupted. Must be lower than the HVSD voltage
	Walk-in On	Y, N	N	The output soft start function means the rectifier voltage will rise from 0V to the Default Volt after the Walk-in time
	Walk-in	8s ~ 128s	8s	
	Interval T	0 ~ 10s	0s	The controller can set the DCDC Interval Start of the rectifiers. Start time = module address x interval time
	AC OverV On	Y, N	N	If you set AC OverV On to 'Y', the rectifier can start forcibly when the AC input overvoltage occurs in the rectifier. The rectifier with least address has this function. If the overvoltage persist for 60s, the function will be canceled automatically
	ACCurrLim	1A ~ 50A	30A	The controller limits the input current of the rectifier in the AC current limiting
System	Lang	Chinese, English	Chinese	Set according to your need
	Tzone	-	-	Set according to actual instance
	Date	2000 ~ 2099	-	Set the time according to the current actual time, regardless of whether it is a leap year or not
	System Type	24V/100 24V/300 24V/500 24V/1000 24V/SET 48V/100 48V/300 48V/500 48V/1000 48V/SET	48V/SET	The system type of the controller has been set according to the actual instance before the controller is delivered with power supply system. You need not to change the value except that the controller is replaced with a new one. After changing the type, the controller will restart automatically and the other parameters will resume the default. You need to reset and change some parameters according to the battery and equipment configured with system
	ComDownLoad	Y, N	N	
	Reset PWD	Y, N	N	Whether resetting the password to the default
	Reset Para	Y, N	N	Whether resetting the parameter to the default
	Op1 PWD	-	-	The password can be 6 digits long at most. If it is shorter than 6 digits, end it with a #
	Op2 PWD	-	-	
	Adm PWD	-	-	
Communication	Address	1 ~ 254	1	The addresses of power systems that are at the same monitored office should be different
	Comm Mode	MODEM	RS232	The system only supports RS232 mode communication MODEM: use the Modem to communicate in telecom protocol

Item	Parameter	Range	Factory setting	Value description
Communication	BaudRate	1200bps ~ 9600bps	9600bps	Make sure the baud rates of both the sending and receiving parties are the same
	IP/Subnet/Gate	-	-	Set according to actual instance
	CallbackTime	-	-	
	Phone Number	-	-	
Energy saving	Save Enable	Y, N	N	It can be set to 'Y' when the battery is configured and load current without instantly shocks
	Cyc Period*	1h ~ 8760h	48h	Time of rectifier under power-on state and power-off state, it can be set according to actual requirement
	Rect Work	30% ~ 90%	80%	Output capacity percentage. More rectifiers will startup to work when larger than this setting percentage
	Rect Limit	1 ~ 30	1	Minimum number of the rectifier
Fast settings	System Type	24V/100 24V/300 24V/500 24V/1000 24V/SET 48V/100 48V/300 48V/500 48V/1000 48V/SET	48V/SET	The system type of the controller has been set according to the actual instance before the controller is delivered with power supply system. You need not to change the value except that the controller is replaced with a new one. After changing the type, the controller will restart automatically and the other parameters will resume the default. You need to reset and change some parameters according to the battery and equipment configured with system
	Capacity	50Ah ~ 5000Ah	300Ah	The capacity of the total battery strings. You should set this parameter according to the actual battery configuration
Note*: Cyc Period, Rect Work and Rect Limit are available when 'Save Enable' is set to 'Y'				

Appendix 4 Menu Structure Of The Controller

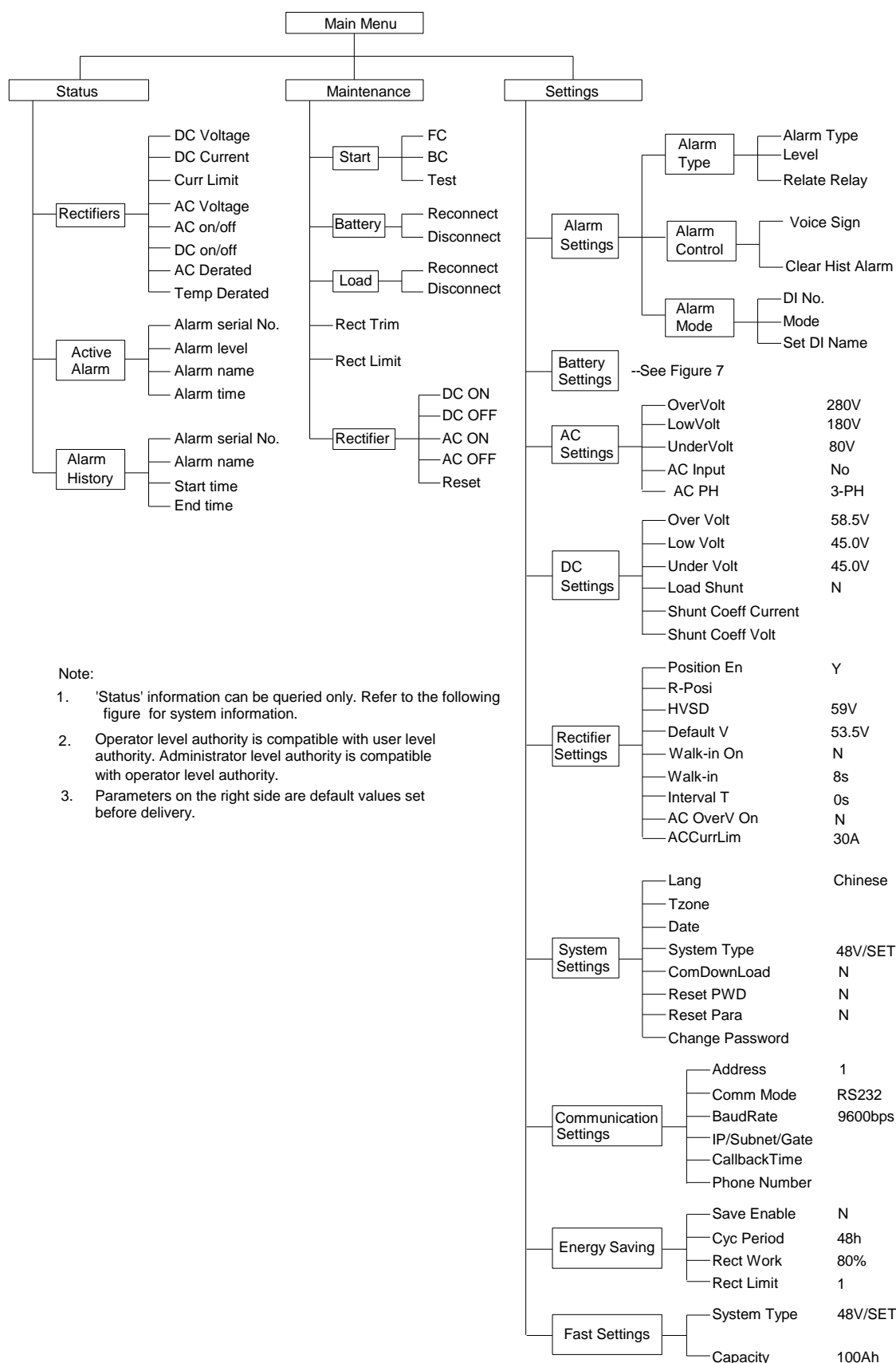

Figure 4 Menu structure of the controller (1)

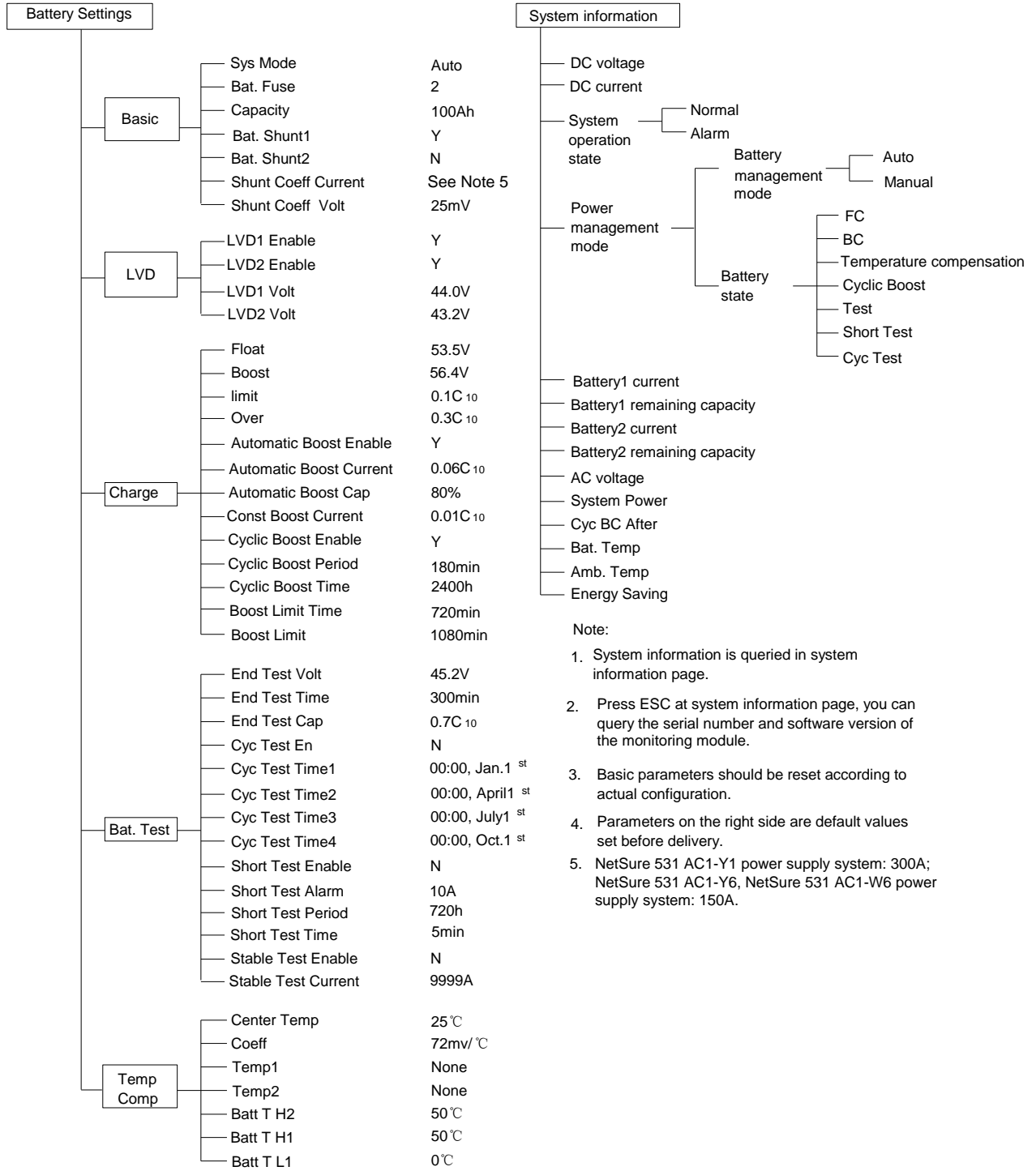

Figure 5 Menu structure of the controller (2)

Appendix 5 Schematic Diagram

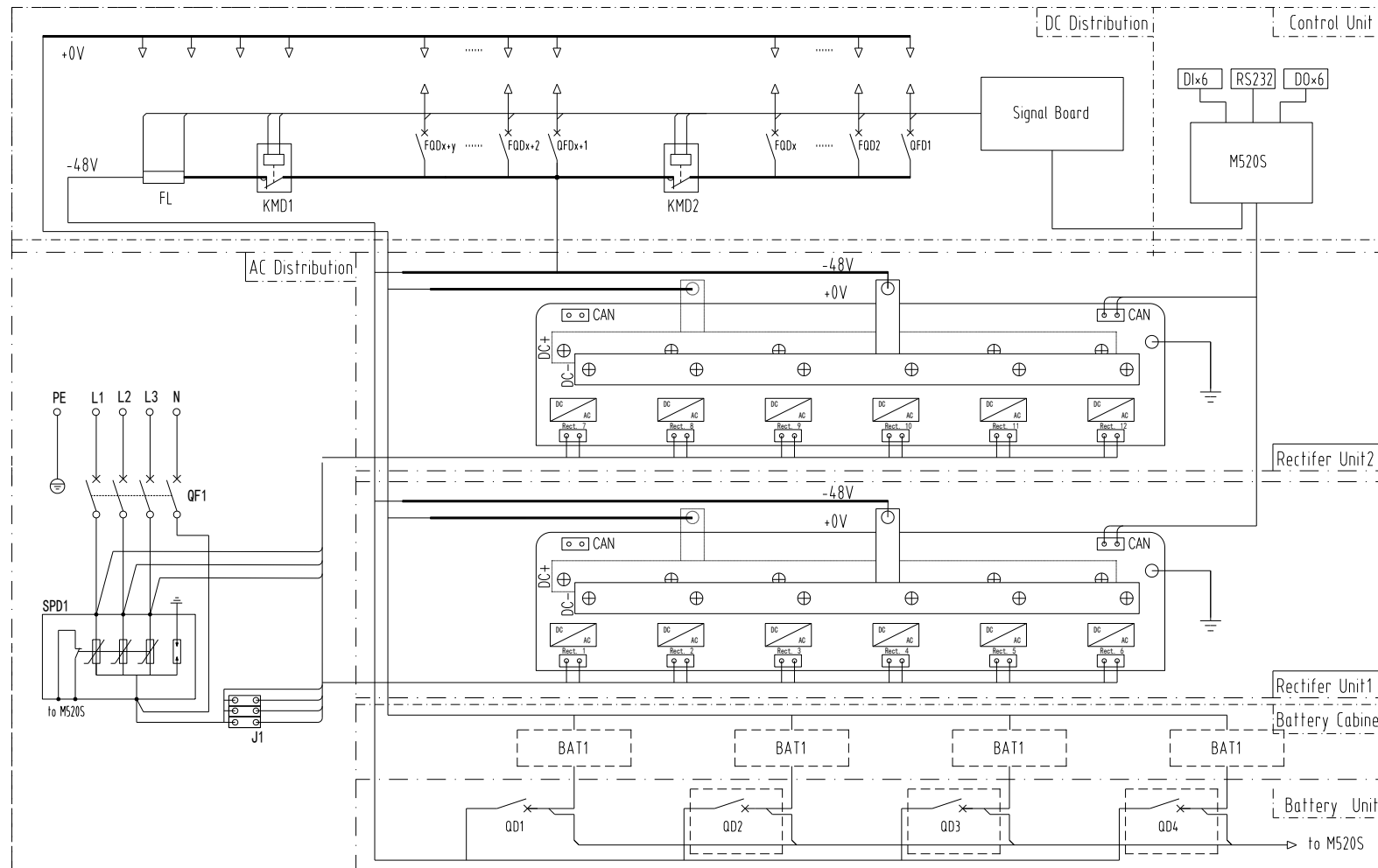

Figure 6 Schematic diagram of NetSure 531 AC1

Appendix 6 Wiring Diagram

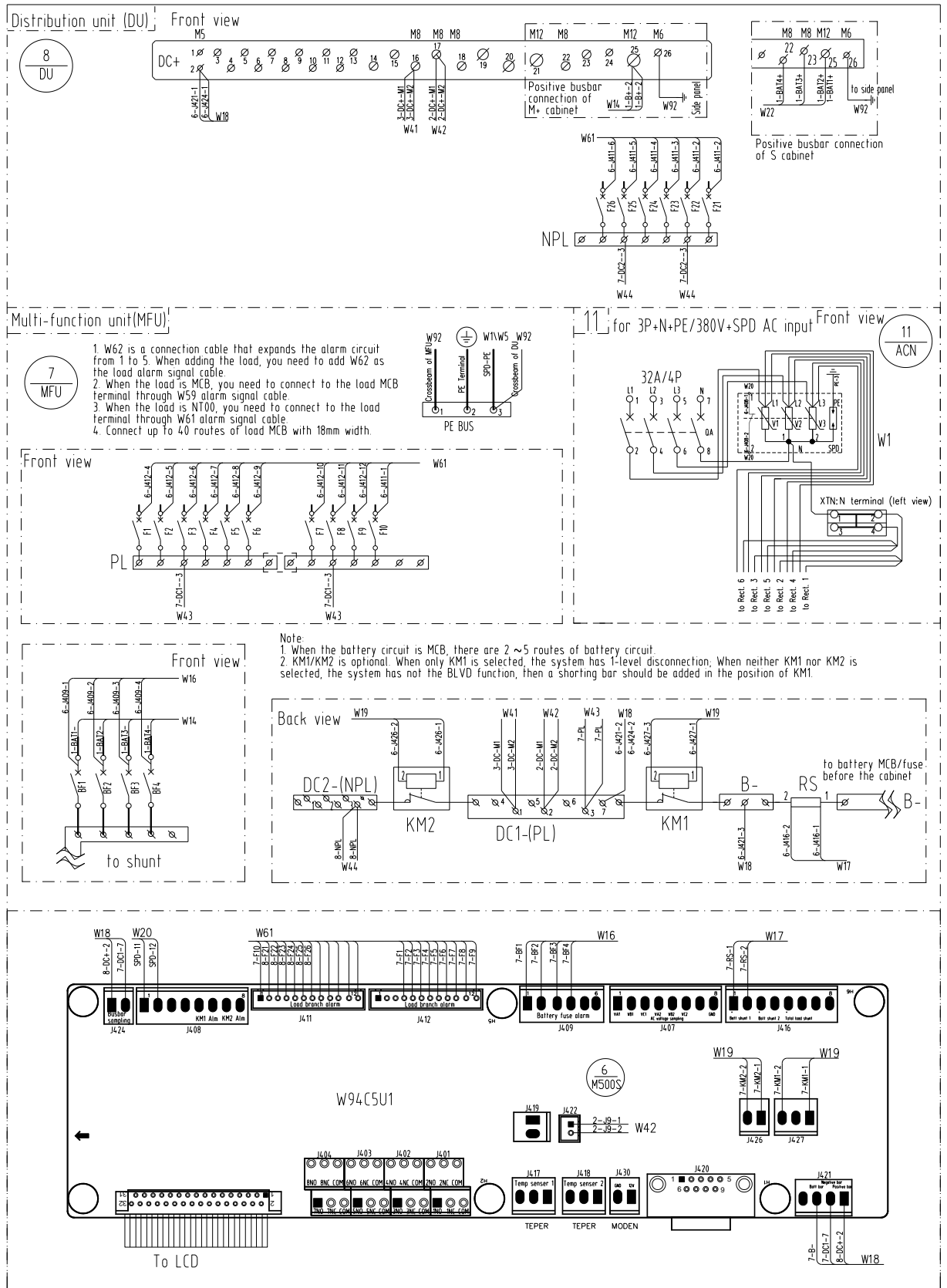
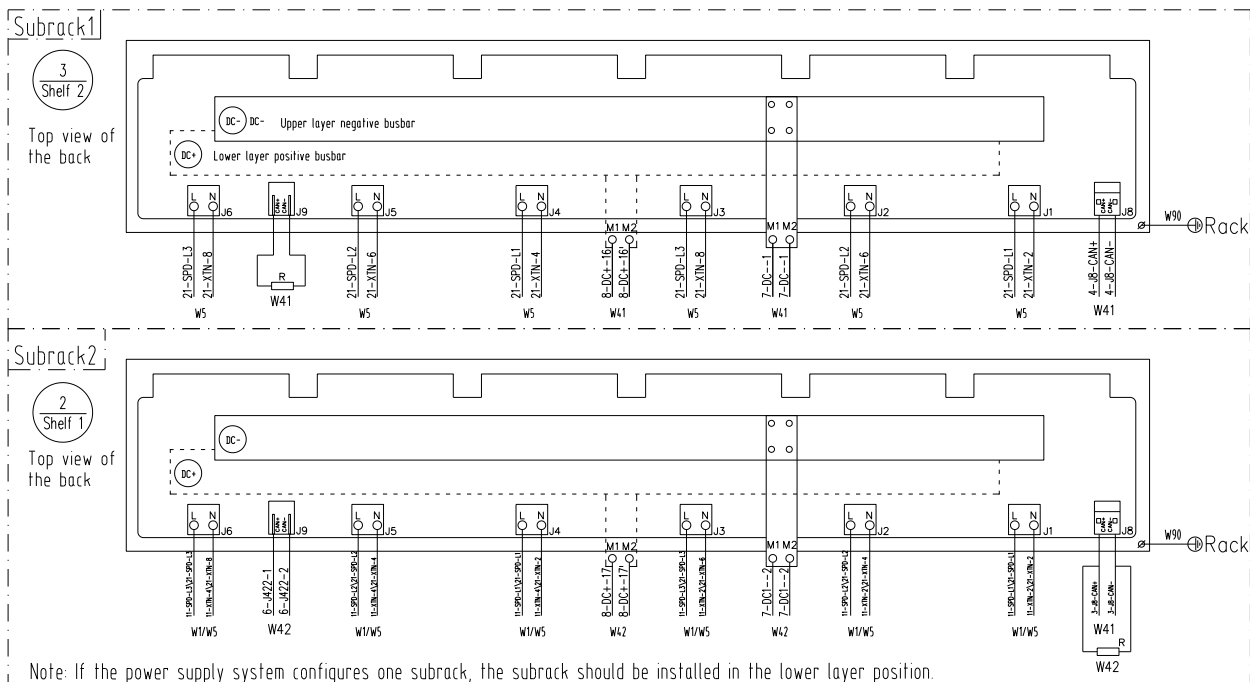
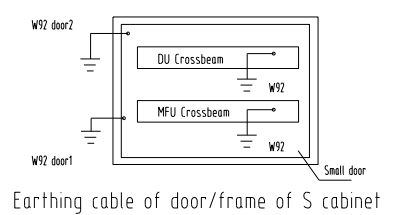
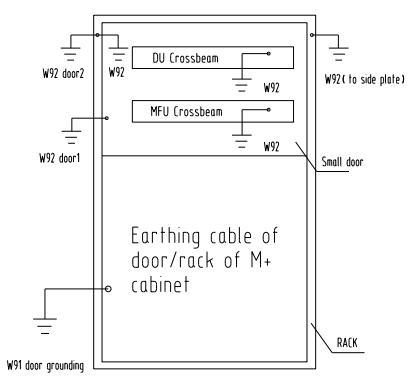
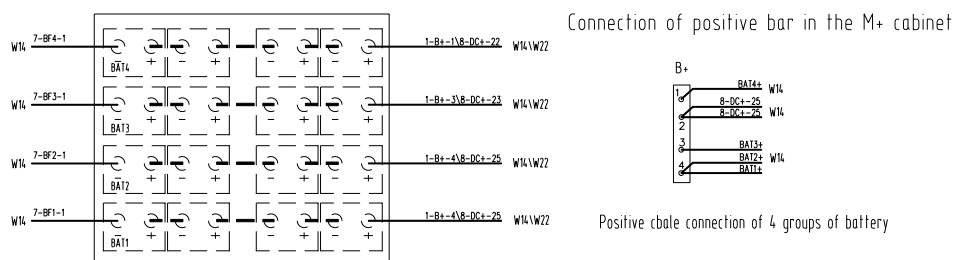

Figure 7 Wiring diagram 1 of NetSure 531 AC1



Battery
1 Battery

Note: 1. The battery cables of the M+ cabinet is W12; The positive busbar cable W14 goes through the B+ bar in the middle of the cabinet, and is connected to the top of the cabinet.
2. The battery cables of the S cabinet is W22, you need to connect the cable by yourself.



Note: The S cabinet has not front door frame, therefore, the RACK earthing cable W92 is not connected in the S cabinet.

Wiring diagram 2 of NetSure 531 AC1

180A system AC input (front view):

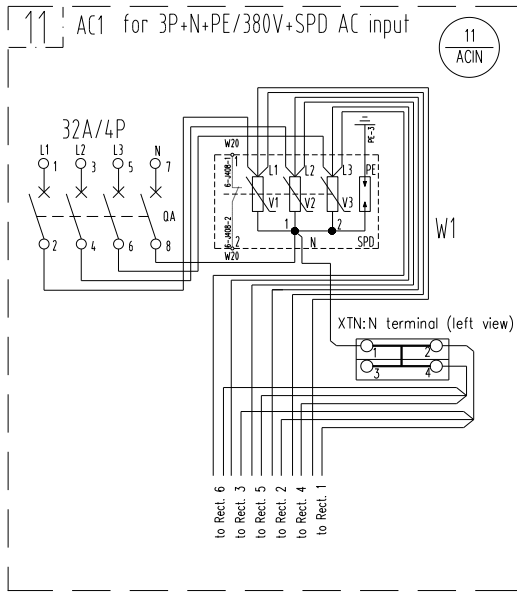

360A system AC input (front view):

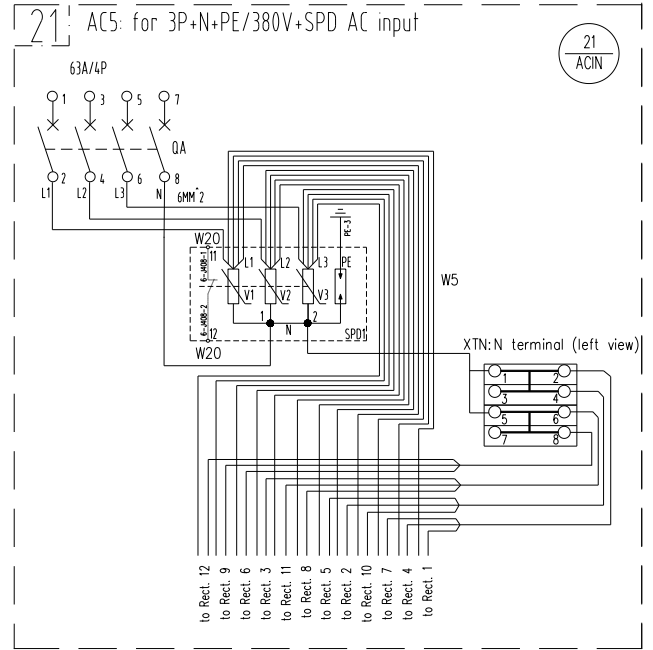

Wiring diagram 3 of NetSure 531 AC1

Appendix 7 Glossary

Abbreviation	Full word
Amb.Temp	Ambient Temperature
Batt	Battery
BC	Boost Charging
BLVD	Battery Lower Voltage Disconnection
Cap	Capacity
CommMode	Communication Mode
CurrLimit	Current Limit
CycBC	Cyclic Boost Charging
Con Alarm Voice	Control Alarm Voice
Hist Alarm	Historical alarm
HVSD	High Voltage Shutdown
InitParam	Initialize Parameters
InitPWD	Initialize Password
LLVD	Load Low Voltage Disconnection
LVD	Low Voltage Disconnection
MCB	Miniature Circuit Breaker
Ph-A	Phase A
PWD	Password
Rect	Rectifier
Shunt coeff	Shunt Coefficient
SPD	Surge Protection Device
SW Version	Software Version
Sys	System
Temp	Temperature
Temp Comp	Temperature Compensation
Volt	Voltage