

Alber Universal Xplorer Telecom Monitor (UXTM) Battery Monitor

Installation Guide

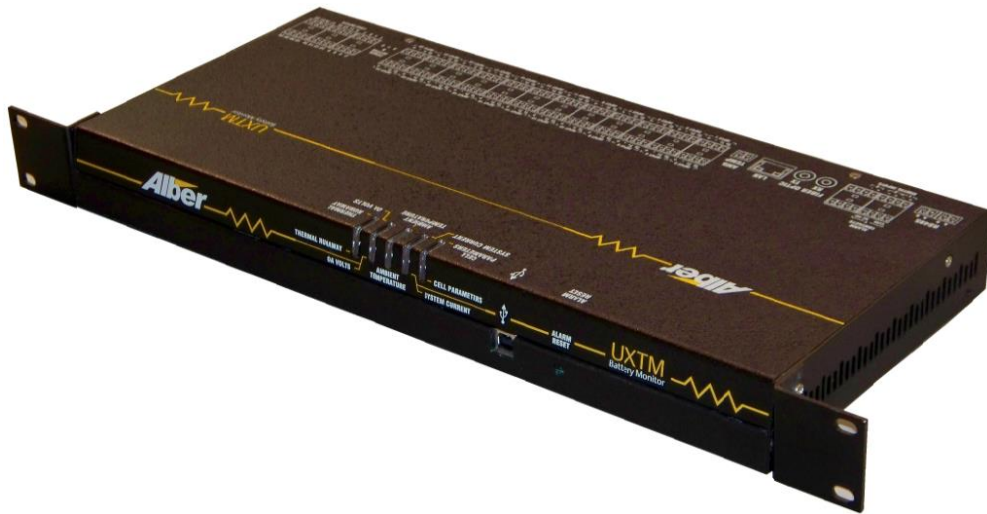

Vertiv Corporation
1050 Dearborn Drive
Columbus, OH 43085
Tel: (954) 623-6660
www.vertivco.com
590-2105-501A/SL-29420/4200-097

The information contained in this document is subject to change without notice and may not be suitable for all applications. While every precaution has been taken to ensure the accuracy and completeness of this document, Vertiv assumes no responsibility and disclaims all liability for damages resulting from use of this information or for any errors or omissions. Refer to other local practices or building codes as applicable for the correct methods, tools, and materials to be used in performing procedures not specifically described in this document.

The products covered by this instruction manual are manufactured and/or sold by Vertiv. This document is the property of Vertiv and contains confidential and proprietary information owned by Vertiv. Any copying, use or disclosure of it without the written permission of Vertiv is strictly prohibited.

Notice to Users

Vertiv Corporation reserves the right to make changes to this document without notice to any user or reseller of this product. Vertiv Corporation also reserves the right to substitute or terminate distribution of this document, with no obligation to notify any person or party of such substitutions or terminations.



EUROPEAN UNION CUSTOMER NOTICE: Disposal of Old Appliances*

This product uses components that are dangerous for the environment, such as electronic cards and other electronic components. Any component that is removed must be taken to specialized collection and disposal centers. If this unit must be dismantled, this must be done by a specialized center for collection and disposal of electric and electronics appliances or other dangerous substances. This product has been supplied from an environmentally aware manufacturer that complies with the Waste Electrical and Electronic Equipment (WEEE) Directive 2002/96/EC. The "crossed-out wheeled bin" symbol to the left is placed on this product to encourage you to recycle wherever possible.

Please be environmentally responsible and recycle this product through your recycling facility at its end of life. Do not dispose of this product as unsorted municipal waste. Follow local municipal waste ordinances for proper disposal provisions to reduce the environmental impact of waste electrical and electronic equipment (WEEE) Directive 2012/19/EU.

For information regarding the scrapping of this equipment, go to www.eu.emersonnetworkpower.com ("Products" or "Contact us" sections) or call Emerson's worldwide technical support at: **00 80011554499 (Toll free number)** or **+39 0298250222 (Toll number based in Italy)**

**This notice only applies to 50Hz units placed on the European Union market.*

Vertiv Customer Service

Vertiv Customer Service is available Monday to Friday, 8:00AM to 4:30PM Eastern Time.

Telephone: (954) 377-7101

Email: alber-service@vertivco.com

Website: www.vertivco.com

Corporate Office Address:

Vertiv Corporation

1050 Dearborn Drive

Columbus, OH 43085

Table of Contents

1.	Safety Information.....	1-1
1.1	General	1-1
1.2	Document Symbols	1-1
1.3	Safety Symbols.....	1-1
1.4	Product Safety Practices.....	1-2
2.	Preventive Maintenance	2-1
2.1	Visual Inspection.....	2-1
2.2	System Component Cleaning.....	2-1
2.3	Sense Lead and Ring Terminal Cleaning.....	2-1
2.4	Internal Component Replacement.....	2-1
3.	System Overview.....	3-1
4.	System Installation	4-1
5.	Materials Received List.....	5-1
6.	System Installation Considerations	6-1
6.1	Disconnect Device.....	6-1
6.2	Equipment Location	6-1
6.3	Rack Mounting.....	6-1
6.4	Mounting Options	6-1
6.5	Wire Length.....	6-1
6.6	Battery String Isolation	6-2
6.7	Cell/Monobloc Number 1 Identification	6-2
7.	Installation of Tab Washers.....	7-1
8.	Unit Configuration.....	8-1
8.1	Digital Input Configuration.....	8-1
8.2	RS-485 Termination.....	8-2
8.3	Power Setting Selection	8-3
9.	Equipment Mounting.....	9-1
9.1	Rack Mounting.....	9-1
9.2	Wall Mounting	9-1
10.	Sense Lead Harness Connection.....	10-1
10.1	System without Cell Temperature	10-1
10.2	System with Cell Temperature	10-3

10.3	System with Dual or Multiple Positive and Negative Posts	10-5
11.	Fused Load Lead Harness Connection	11-1
12.	Ambient Temperature Sensor Connection.....	12-1
13.	Digital Inputs Connection	13-1
14.	RS-485 Communication Connection	14-1
15.	Fiber Optic Communication Connection	15-1
16.	Network Communication Connection	16-1
16.1	Network Protocols Supported.....	16-1
17.	Alarm Contact Connection	17-1
18.	Installing Strain Relief Kit.....	18-1
19.	Drawings	19-1
20.	Index	20-1

List of Figures

Figure 1 - Typical System Connection	3-1
Figure 2 - Exposed Post Tab Washer Assembly.....	7-1
Figure 3 - Recessed Post Tab Washer Assembly.....	7-1
Figure 4 - Digital Input Jumper Locations.....	8-2
Figure 5 - RS-485 Jumper Locations	8-2
Figure 6 - Power Settings Switch Location	8-4
Figure 7 - 19” Rack Mount View	9-1
Figure 8 - Wall Mount View.....	9-1
Figure 9 - Exposed Post with Standard Tab Washers without Cell Temperature Sensor.....	10-1
Figure 10 - Recessed Post with Ring Terminal Washers without Cell Temperature Sensor	10-2
Figure 11 - Exposed Post with Wired Tab Washers with Cell Temperature Sensor.....	10-3
Figure 12 - Recessed Post with Ring Terminal Washers with Cell Temperature Sensor.....	10-4
Figure 13 - Exposed Dual or Multiple Posts with Wired Tab Washers without Cell Temperature Sensor.....	10-5
Figure 14 - Single Post Design	10-6
Figure 15 - Double Post Design.....	10-7
Figure 16 - Triple Post Design.....	10-8
Figure 17 - Fused Load Lead.....	11-1
Figure 18 - Load Input Connections	11-1
Figure 19 - 12’, 25’ or 50’ Temperature Harness	12-1
Figure 20 - Ambient Temperature Input.....	12-1
Figure 21 - Digital Inputs.....	13-1
Figure 22 - RS-485 Connections.....	14-1
Figure 23 - Minimum Fiber Optic Bend Radius.....	15-1
Figure 24 - Network Connection	16-1
Figure 25 - Alarm Contacts.....	17-1
Figure 26 - Installed Strain Relief Kit with Wires Running through Strain Relief Bracket.....	18-1

List of Tables

Table 1 - Installation Task List 4-1
Table 2 - Inventory List 5-2
Table 3 - Digital Input Modes..... 8-1
Table 4 - Digital Input Jumper Settings 8-1

1. Safety Information

1.1 General



The protective features of this product may be compromised if it is used in a manner not specified in this guide and/or related operation or installation instructions. This manual describes general installation of the system. If the system has features or accessories not described in this manual, contact Vertiv.

The following general safety precautions must be observed during all phases of operation, service, and repair of this product. Failure to comply with these precautions or with specific warnings elsewhere in this manual violates safety standards of design, manufacture, and intended use of the product. Vertiv assumes no liability for the customer's failure to comply with these requirements.

 Note	<ul style="list-style-type: none"> • Use safety equipment when working in and around the batteries. • Never energize the UXTM until after the installation is complete. • Never exceed equipment voltage, power ratings or capabilities.
--	---



1.2 Document Symbols

The symbols below appear in this manual or are affixed to the Vertiv device. It is important to review these symbols and to understand the type of instructional information they convey.

 Warning	<p>Highlights areas related to user safety.</p> <p>Calls attention to a procedure, practice, or condition which, if not correctly followed, could result in personal injury. Do not proceed beyond a Warning symbol until the indicated conditions are fully understood and met. Always observe safety information when installing, setting up or operating this product.</p>
 Caution	<p>Highlights areas related to product or data safety.</p> <p>Calls attention to an operating procedure or condition which, if not correctly followed, could result in damage to the product or permanent loss of data. Do not proceed beyond a Caution symbol until the indicated conditions are fully understood and met.</p>
 Note	<p>The Note symbol calls attention to important information.</p> <p>Describes additional information to help the user.</p>

1.3 Safety Symbols

The following symbols may appear on the system or individual equipment.

	Caution. Risk of danger.
	Equipment protected throughout by double insulation or reinforced insulation.

1.4 Product Safety Practices

The following describe safety practices particular to the installation or operation of the product.

Equipment Service

Proper installation and testing are essential to the correct functioning of the system. If you have questions, contact Vertiv and request monitor assistance. Except as explained in this manual, do not attempt to service Vertiv equipment.

Any adjustment, maintenance or repair of this product must be performed by qualified personnel. Contact a Vertiv customer service engineer and request assistance. Only qualified and trained personnel may perform the operations described in this manual. All safety information must be read, understood, and strictly adhered to before installing, powering up or using the equipment or software (the "system".)

Equipment Grounding

To minimize shock hazard, the system chassis must be connected to an electrical protective earth ground when required. When AC mains are used for the power source, the system must be connected to the AC power mains through a grounded power cable, with the ground wire firmly connected to an electrical safety ground at the power outlet.

Fuses

For continued protection, fuses with the required rated current, voltage, and type, such as normal, slow blow, fast blow or time delay, must be used.

Equipment Access

Operating personnel must not remove equipment covers, shields or panels. Component repair, replacement, and internal adjustments must be made only by qualified service personnel.

Operating Damaged Equipment

Do not operate damaged equipment. Equipment that appears damaged or defective must be made inoperative and secured against unintended operation until repaired by qualified service personnel. Whenever it is possible that the safety protection features built into this product have been impaired, either through physical damage, excessive moisture or any other reason, remove power and do not use the product until safe operation can be verified by qualified service personnel. If necessary, contact Vertiv to ensure the safety features are maintained.

Servicing and Adjusting

Do not service or adjust alone. While in the battery circuit, do not attempt internal service or adjustment of this equipment unless another person, capable of calling for or rendering first aid and resuscitation, is present.

Substituting Parts or Modifying Equipment

Do not substitute parts or modify equipment. Due to the possibility of introducing additional hazards, do not substitute parts or perform any unauthorized modification to the product. If necessary, contact Vertiv to ensure the safety features are maintained.

Safety Information

Insulation Rating For Wires

Use only wire supplied with the installation kit.

Ventilation

Never block equipment ventilation ports or openings. The equipment must have adequate ventilation to prevent overheating. Ensure equipment is operated within specified temperature and humidity ranges.

2. Preventive Maintenance

This section describes preventive maintenance for the UXTM system.

2.1 Visual Inspection

Visually inspect all monitor system components for damaged or frayed power cords and cables and for damaged component panels, controls, and connectors. When damage is detected, remove the equipment from service until the damage is repaired.

2.2 System Component Cleaning

Clean system components using a soft cloth. Do not use commercial or industrial cleaners that may attack the computer display and housing. Never expose the computer or system components to water, high humidity or dampness.



Warning: Before cleaning equipment, ensure the system is disconnected and power to the units has been shut off. You must disconnect the system components and the monitor system cabinet, if a cabinet is being used, from AC and/or DC power sources.

2.3 Sense Lead and Ring Terminal Cleaning

On some applications, cleaning the sense leads where they connect to the battery may be necessary. This is normally needed when monitoring flooded batteries because electrolyte can drip or splash onto the sense lead connections. Sense leads exposed to electrolyte must be neutralized. Follow the battery manufacturer's recommendations for cleaning battery connections.

2.4 Internal Component Replacement

The monitor system has no user replaceable components. Since high voltage exists in most of the system components, only knowledgeable users should remove the covers from components. Failure to comply with this restriction could pose a safety hazard and/or void the product warranty.

3. System Overview

The Vertiv Universal Xplorer Telecom Monitor (UXTM) Battery Monitor Diagnostic and Acquisition Module is a stationary battery monitor designed for use in telecommunications or DC powered data centers. The system architecture is a flexible design that allows for monitoring virtually any battery configuration using VLA, VRLA or NiCd technologies in 24 to 48VDC applications. What sets Vertiv monitors apart from others is the ability to provide early warning of potential battery problems. The monitor checks the state of health of each cell and its associated connections by performing a proactive, patented resistance test, a proven technology to predict battery performance reliably.

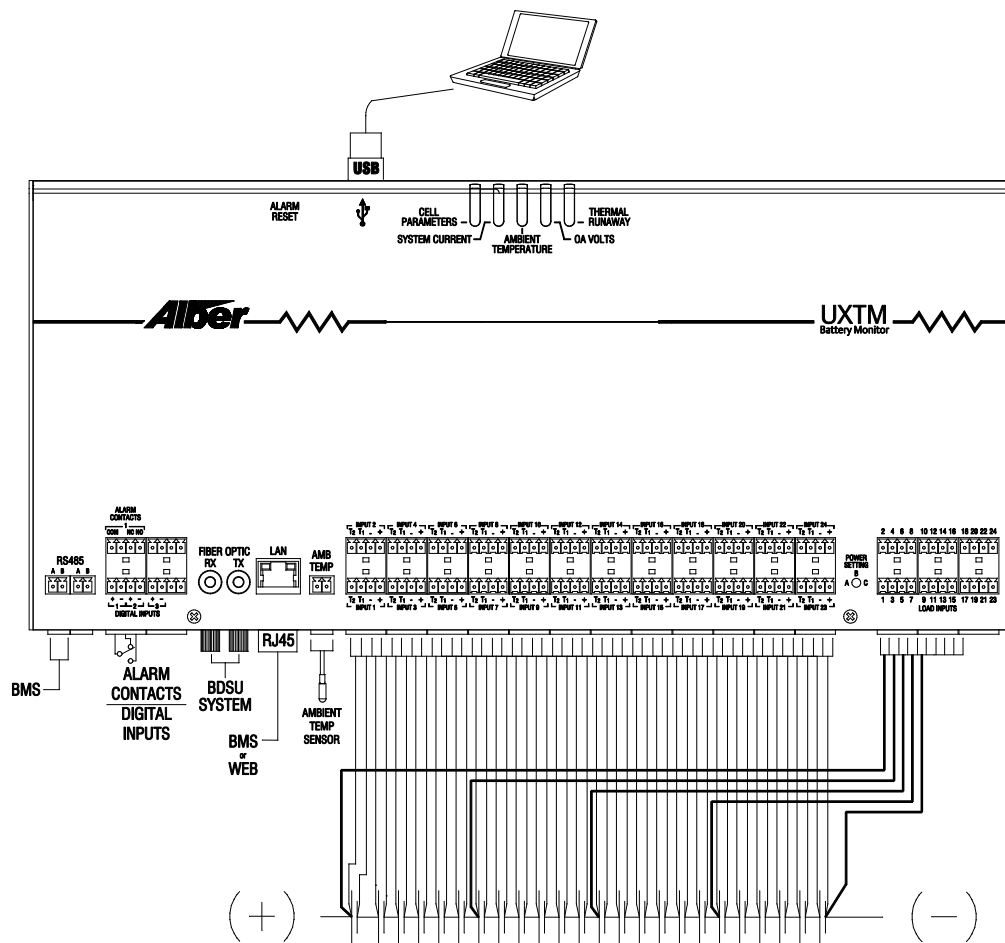

Figure 1 - Typical System Connection

4. System Installation



Note: The UXTM must be installed in a restricted access location.

UXTM installation requires nothing more than standard hand tools, cutters, strippers and screwdrivers. If the unit is to be wall mounted, a drill will also be required.









The following is a list of the steps required for successful UXTM system installation. Some items may not apply due to system requirements.

Installation Task	Refer to Section
Verify materials ordered and received	Materials Received List, page 5-1
Items to consider before system installation	System Installation Considerations, page 6-1
Isolate the battery string	Battery String Isolation, page 6-2
Identify cell/monobloc Number 1	Cell/Monobloc Number 1 Identification, page 6-2
Properly install the tab washers	Installation of Tab Washers, page 7-1
Configure the unit	Unit Configuration, page 8-1
Mount the equipment	Equipment Mounting, page 9-1
Connect the sense lead harnessing	Sense Lead Harness Connection, page 10-1
Connect the fused load lead harnessing	Fused Load Lead Harness Connection, page 11-1
Connect the ambient temperature sensor	Ambient Temperature Sensor Connection, page 12-1
Connect the digital inputs	Digital Inputs Connection, page 13-1
Connect RS-485 communications if applicable	RS-485 Communication Connection, page 14-1
Fiber Optic Communication Connection if applicable	Fiber Optic Communication Connection, page 15-1
Network Communication Connection if applicable	Network Communication Connection, page 16-1
Connect the alarm contacts if applicable	Alarm Contact Connection, page 17-1
Install the wire strain relief kit	Installing Strain Relief Kit Alarm Contact Connection, page 18-1

Table 1 - Installation Task List

5. Materials Received List

The following is a list of material that may have been received with your shipment. Refer to the packing slip delivered with the equipment for a complete list of materials supplied. Vertiv suggests you inventory all materials to ensure the order is complete. Report any shortages to Vertiv immediately.

Part Number	Photo/Drawing	Description
1007-XXX		UXTM module
1102-153-12 1102-153-25 1102-153-50		12', 25' or 50' sense lead harness with quick connect terminal
1102-160-12 1102-160-25 1102-160-50		12', 25' or 50' fused load lead with quick connect terminal
1102-161-12 1102-161-25 1102-161-50		12', 25' or 50' sense lead harness with ring terminal connection
1102-162-12 1102-162-25 1102-162-50		12', 25' or 50' fused load lead with ring terminal connection
2900-047-12 2900-047-25 2900-047-50		12', 25' or 50' harness with ring terminal temperature sensor
2900-048-12 2900-048-25 2900-048-50		12', 25' or 50' harness with quick connect temperature sensor
3703-006		25' Fiber Optic Cable Communication link between units

Materials Received List

Materials Received List (Continued)

Part Number	Photo/Drawing	Description
KIT-3703-015		Fiber Optic Polishing Kit The kit provides the user with polishing materials to terminate the ends of plastic optical fiber correctly.
1102-154-12 1102-154-25 1102-154-50		12', 25' or 50' harness with quick connect ambient temperature sensor
4301-015		15 AMP SB fuse. One for each fused lead
2140-047		4 pin connector for terminating harnesses
2025-108		USB cable
2120-066B		5/16" dual tab washer for sense/load lead connections
2120-030B		5/16" single tab washer for sense/load lead connections
2027-029		Software installation CD
6004-001		Cable number labels
KIT-1200-376		Rack mounting kit
KIT-1200-377		Wall mounting kit
KIT-1200-378		Strain relief kit

Table 2 - Inventory List

6. System Installation Considerations

This section describes items that should be considered before installing the UXTM system.

6.1 Disconnect Device

The first load connector which plugs into load inputs 1, 3, 5 and 7 is the primary disconnect device. Unplug this connector to disconnect power from the UXTM.

6.2 Equipment Location



Note: Consider the placement of the equipment in the event service is required. For example, access to the rear of the equipment or visual access to the status lights may be needed. The equipment is convection cooled and no cooling fans are used. To maintain proper operating temperature, the equipment must not be enclosed in another cabinet without proper ventilation.

6.3 Rack Mounting

If installed in a closed or multi-unit rack assembly, the operating ambient temperature of the rack environment may be greater than room ambient. Therefore consideration should be given to installing the equipment in an environment compatible with the maximum ambient temperature specified in the Product Description Guide.

Installation of the equipment in a rack should be such that the amount of air flow required for safe operation of the equipment is not compromised.

Mounting of the equipment in the rack should be such that a hazardous condition is not achieved due to uneven mechanical loading.

6.4 Mounting Options

The equipment can accommodate two types of mounting: 19" rack mount or wall mount. If the rack mount option is used, brackets (included) will need to be installed.

6.5 Wire Length



Note: All sense lead harnesses come prefabricated to a 12', 25' or 50' length and, in most cases, should not require additional lengths. In fact, the sense leads are un-terminated on one end so they may easily be shortened for a cleaner installation. The resistance load test-wiring limits this length to the maximum distance the UXTM can be mounted from the battery string. This manual describes all harnesses at the standard 12', 25' or 50' length.

6.6 Battery String Isolation



Warning: Isolate the battery string prior to installing the system.

Important!: Never attempt installation on a battery string that is in service and not fully isolated from the DC bus and load circuits.

6.7 Cell/Monobloc Number 1 Identification

When referring to any material in this installation guide and reference is made to an actual cell number, always consider Number 1 as the most positive end of the battery with respect to the battery charger. As the cells increment toward the negative end of the string, increment the cell numbers as well.

7. Installation of Tab Washers

Tab washers allow connection of the monitoring system to the battery. Some tab washers are supplied with single or double tabs. These types are for use on cells that have exposed connections not restricted by safety covers. The tab washer style, location and quantity depend on whether the system is monitoring cell temperature. The actual placement of these tab washers in relation to the battery post and existing hardware is critical. In instances where a single tab washer is required, this should be placed closest to the cell post and underneath the double tab washer. The following figures illustrate some common applications.

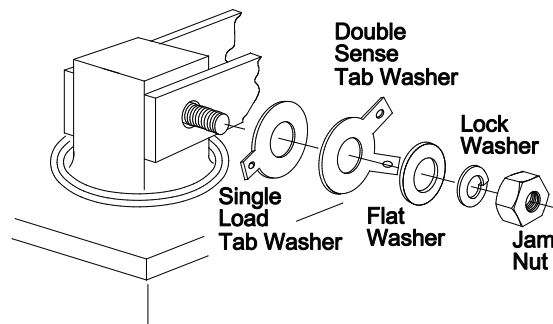

Figure 2 - Exposed Post Tab Washer Assembly

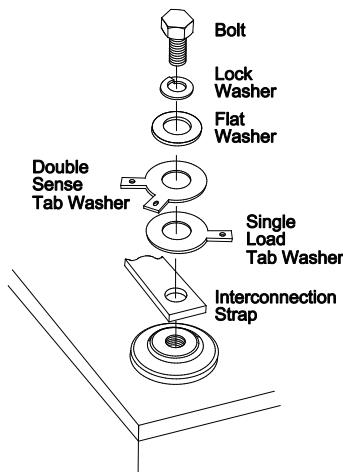

Figure 3 - Recessed Post Tab Washer Assembly

To determine tab washer placement, refer to the Configuration Connection Diagram at the back of this manual. Locate the desired configuration that will be installed and refer to the appropriate row of tabs: "for optional Cell Temperature" or "for no Cell Temperature." There is an actual image of the tab washer required. Using the wiring diagram above the tab washer image, install the appropriate tab on each required post.

8. Unit Configuration

8.1 Digital Input Configuration

Each digital input can be configured either for a voltage or contact closure input. Refer to the table below.

Note: Digital input configuration should be only performed by a qualified technician. Contact Technical Support for details.

Mode	Acceptable Input Range
Voltage	> 4V = False < 1V = True Maximum nondestructive input: 60Vdc
Open/Close Contact	< 2K = True

Table 3 - Digital Input Modes

Seven Jumpers are supplied with the UXTM for configuration. There is a pair of 2-pin jumpers associated with each digital input, which must be set according to the mode desired. The cover of the unit must be removed to gain access to these jumpers. Refer to the following table and drawing to identify what mode is required and where the jumpers are.

Channel	Mode	Jumpers
Digital Input 1	Voltage	JP24 & 25 Not Installed
	Open/Close Contact	JP24 & 25 Installed (default)
Digital Input 2	Voltage	JP26 & 27 Not Installed
	Open/Close Contact	JP26 & 27 Installed (default)
Digital Input 3	Voltage	JP28 & 29 Not Installed
	Open/Close Contact	JP28 & 29 Installed (default)

Table 4 - Digital Input Jumper Settings

The location of the jumpers is shown in the figure below.

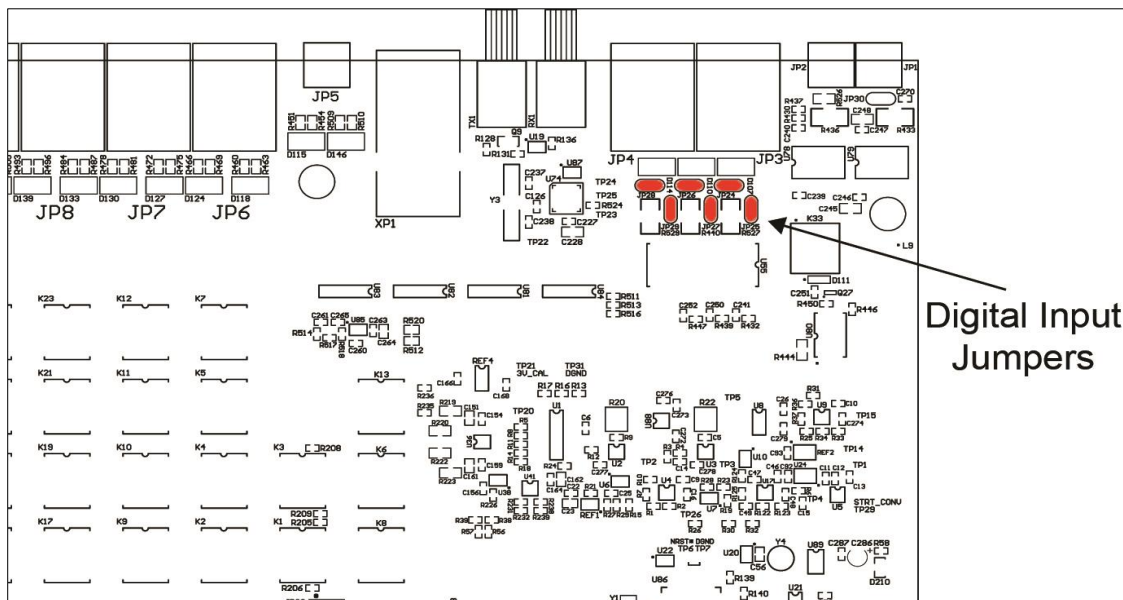

Figure 4 - Digital Input Jumper Locations

8.2 RS-485 Termination

A jumper on the circuit board is used for selecting a termination resistor for RS-485 connection. In most cases, RS-485 termination is not necessary because maximum baud rate is 19200 bps (default is 9600). RS-485 termination is recommended when intermittent communications occur. RS-485 termination is enabled when the jumper is across Pins 1 and 2 (default). It is disabled when the jumper is not inserted across Pins 1 and 2. The location of the jumper is shown in the figure below.

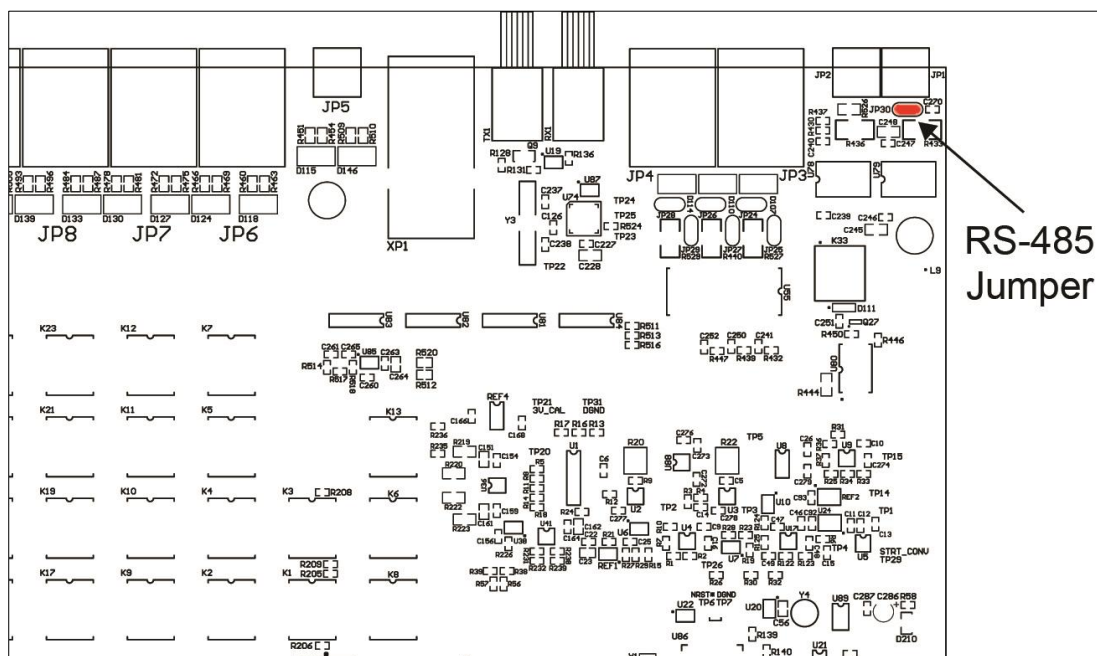

Figure 5 - RS-485 Jumper Locations

8.3 Power Setting Selection

The power setting identifies what load input wires will provide power to the equipment. There are three possible settings described in the chart below. In the chart, the battery configuration is defined as Number of Strings x Number of Jars/Cells x Voltage of each Jar/Cell.

Battery Configuration	Power Setting
1X18X1V	B
1X12X2V	B
2X12X2V	B
1X24X2V	C
1X6X4V	A
2X6X4V	A
3X6X4V	A
4X6X4V	A
1X12X4V	C
2X12X4V	C
1X4X6V	C
2X4X6V	C
3X4X6V	C
4X4X6V	C
1X8X6V	C
2X8X6V	C
3X8X6V	C
1X3X8V	B
2X3X8V	B
3X3X8V	B
4X3X8V	B
1X6X8V	B
2X6X8V	B
3X6X8V	B
4X6X8V	B
1X2X12V	A
2X2X12V	A
3X2X12V	A
4X2X12V	A
1X4X12V	C
2X4X12V	C
3X4X12V	C
4X4X12V	C

Battery Configuration	Power Setting
1X3X16V	B
2X3X16V	B
3X3X16V	B
4X3X16V	B

Table 5 - Configuration List (Continued)

The power setting switch is located on the rear of the UXTM and is shown below. Use a small screwdriver to set this switch to A, B or C.

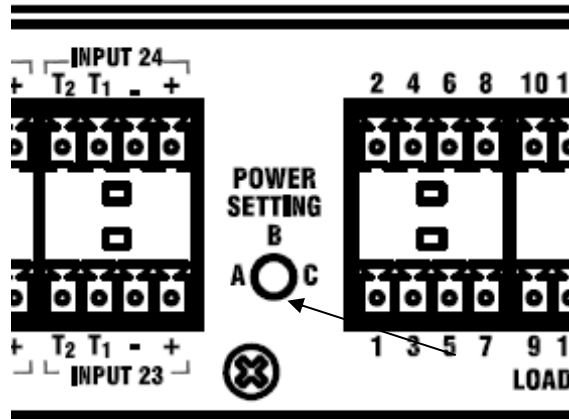

Figure 6 - Power Settings Switch Location

9. Equipment Mounting

The equipment can accommodate two types of mounting: 19" rack mount or wall mount.

9.1 Rack Mounting

If the rack mount option is used, optional angle brackets (included) will need to be installed on each side of the unit. To connect the rack mount brackets to the unit, align the screw holes of the brackets with the sides of the unit. Remove the upper flat head screws on each side and secure the rack mount brackets to the unit using the supplied screws. Mount the equipment in the 19" rack using appropriate screws and washers.

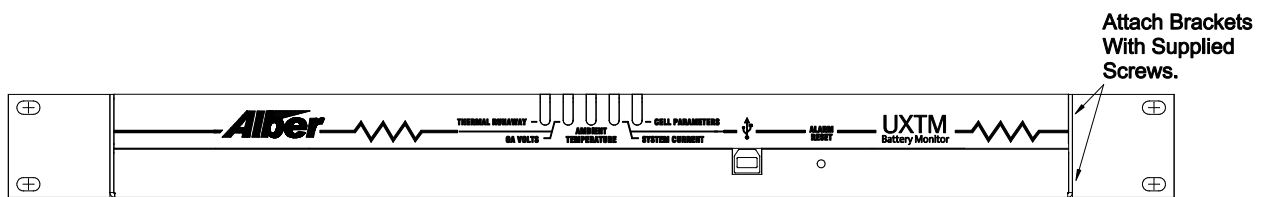

Figure 7 - 19" Rack Mount View

9.2 Wall Mounting

If wall mounting is used, optional right angle brackets are required (ordered separately) and must be attached to the unit using the supplied screws. To mount the unit on the wall, special consideration should be given to determine the best method for securing the unit. There are several types of anchoring techniques available, depending on the type of structure the mount is being attached to. The best anchoring technique must be determined by the installer at the time of installation.

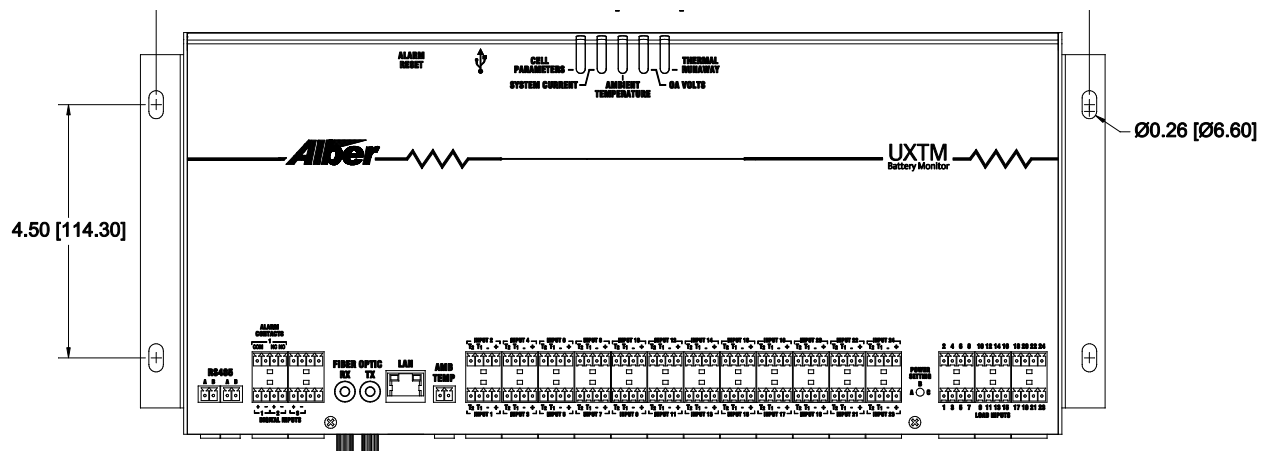

Figure 8 - Wall Mount View

10. Sense Lead Harness Connection

The type of battery and whether cell temperature is monitored determines what sense lead cable is used. Refer to the following sections to determine which applies to the installation being performed.

10.1 System without Cell Temperature

Systems that do not monitor the cell temperature will have only one sense lead attached to each terminal of the battery. There is one sense lead assembly with either a 12', 25' or 50' of cable for each cell being monitored. This cable is factory terminated on the end that attaches to the battery. The other end must be cut to length, stripped, and secured to the connector with the connector's set screws. After terminating the cable to the connector, be sure to place a wire marker at the connector end to identify which cell it is monitoring for connector placement.



Warning: Connect the wires at the terminated end (UXTM) first, then terminate the sense leads to the appropriate cell/unit. Be sure to, measure the potential across leads and connectors for correct voltage before connecting the UXTM to the battery. Once the load cables and sense lead connections are verified with a DMM, the wires can then be connected to the UXTM. Do not install fuses to the UXTM until it is appropriate. Follow the order to terminate the sense leads. The potential for shorting the circuits here is significant.

The following illustrations show this scenario and must be duplicated for each cell.

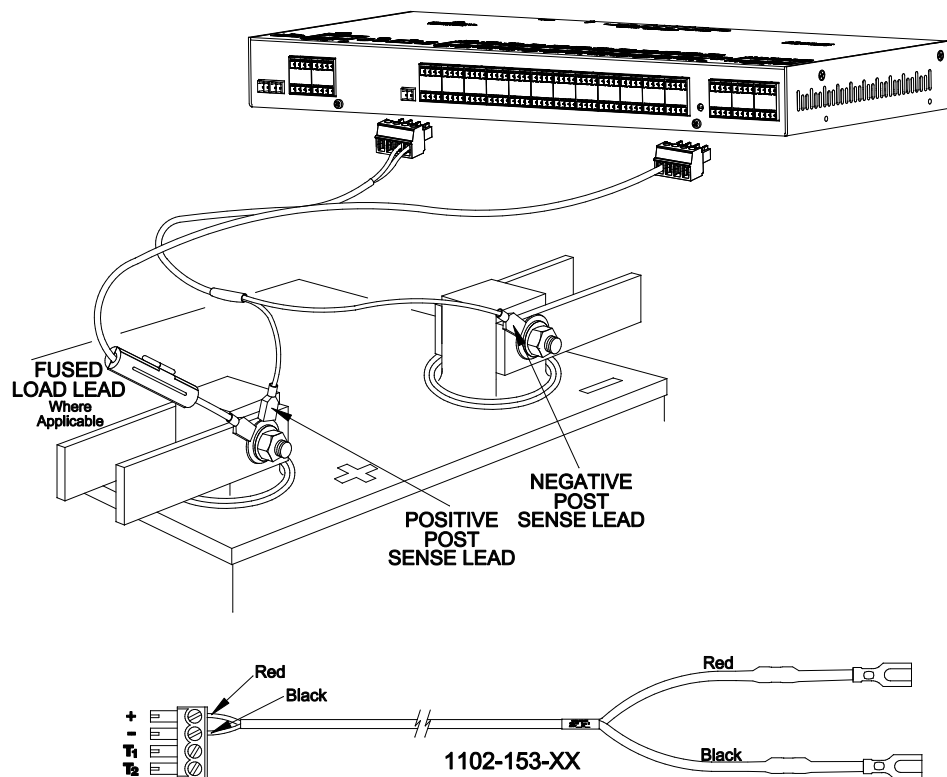

Figure 9 - Exposed Post with Standard Tab Washers without Cell Temperature Sensor

Sense Lead Harness Connection

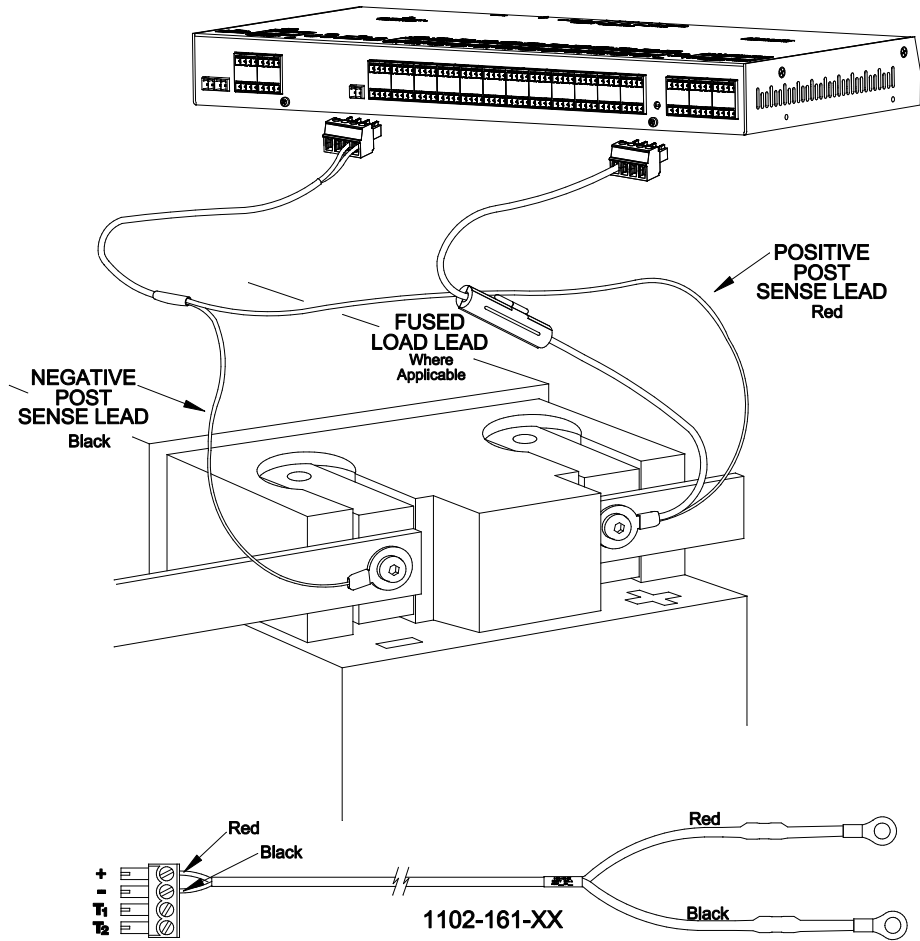

Figure 10 - Recessed Post with Ring Terminal Washers without Cell Temperature Sensor

10.2 System with Cell Temperature

Systems that monitor the cell temperature will have a choice of two types of sense lead harnesses. The first harness uses a quick connect for the temperature sensor, and the second harness uses a ring terminal for the temperature sensor. In either case, the red and black leads of the harness attach to the corresponding terminals of the battery (red-positive, black-negative). The temperature sensor will either connect to a tab washer quick connect or be secured under the bolt for the intercell connector, depending on the type of cell being monitored. This cable is factory terminated on the end that attaches to the battery. The other end must be cut to the desired length, stripped, and attached to the connector with the connector's set screws. After terminating the cable to the connector, be sure to place a wire marker at the connector end to identify which cell it is monitoring for connector placement. The following illustrations show this scenario and must be duplicated for each cell.

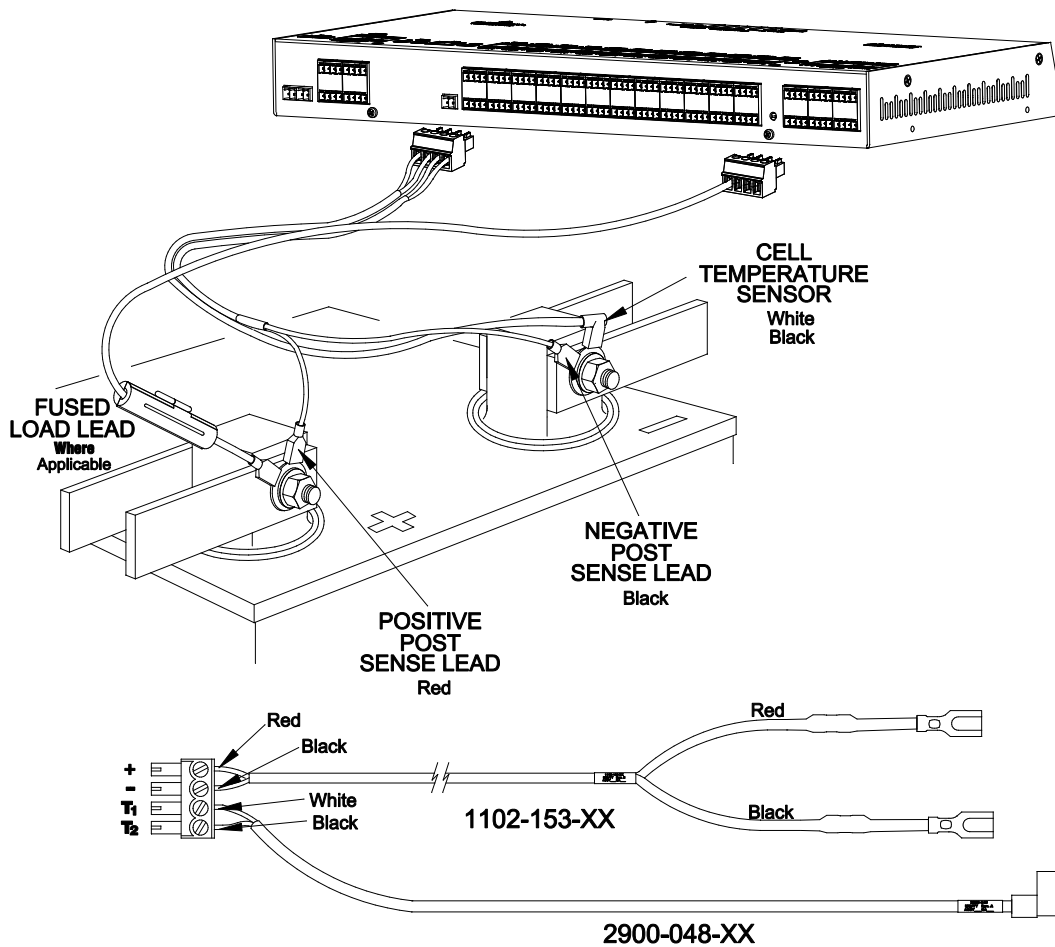

Figure 11 - Exposed Post with Wired Tab Washers with Cell Temperature Sensor

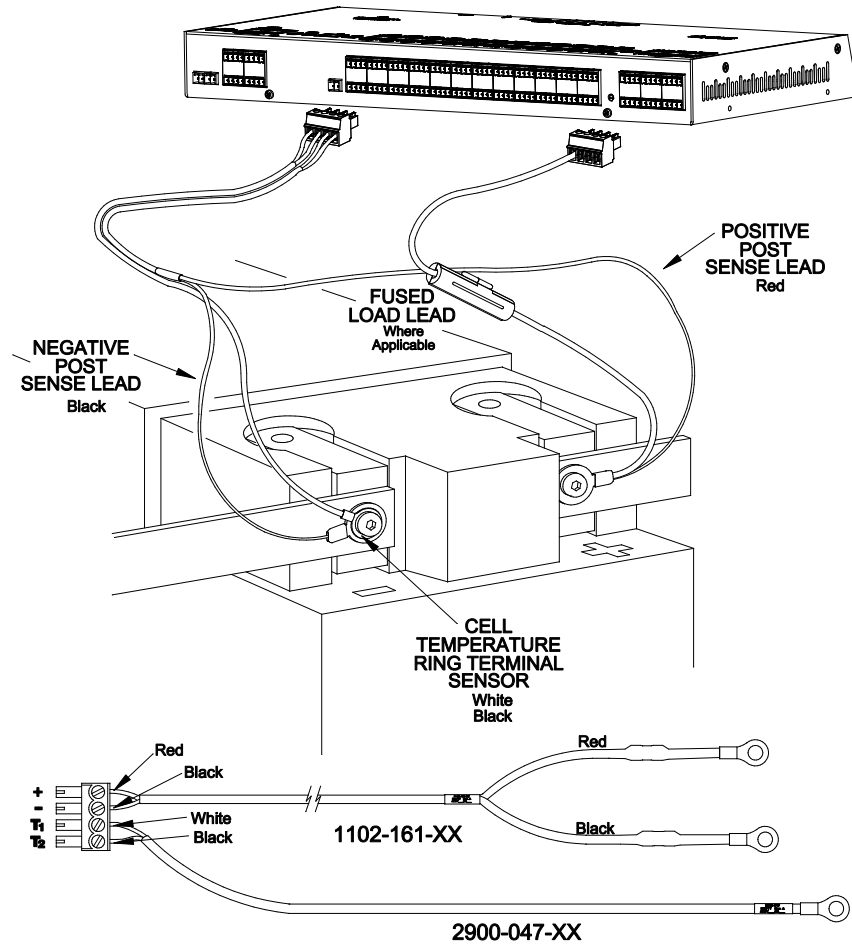

Figure 12 - Recessed Post with Ring Terminal Washers with Cell Temperature Sensor

10.3 System with Dual or Multiple Positive and Negative Posts

Systems may have dual or multiple positive and negative posts to connecting to sense lead harnesses. The red and black leads of the harness attach to the corresponding terminals of the battery (red-positive, black-negative). This cable is factory terminated on the end that attaches to the battery. The other end must be cut to the desired length, stripped, and attached to the connector with the connector's set screws. After terminating the cable to the connector, be sure to place a wire marker at the connector end to identify which cell it is monitoring for connector placement. The following illustrations show a scenario of dual or multiple positive and negative posts and must be duplicated for each cell.

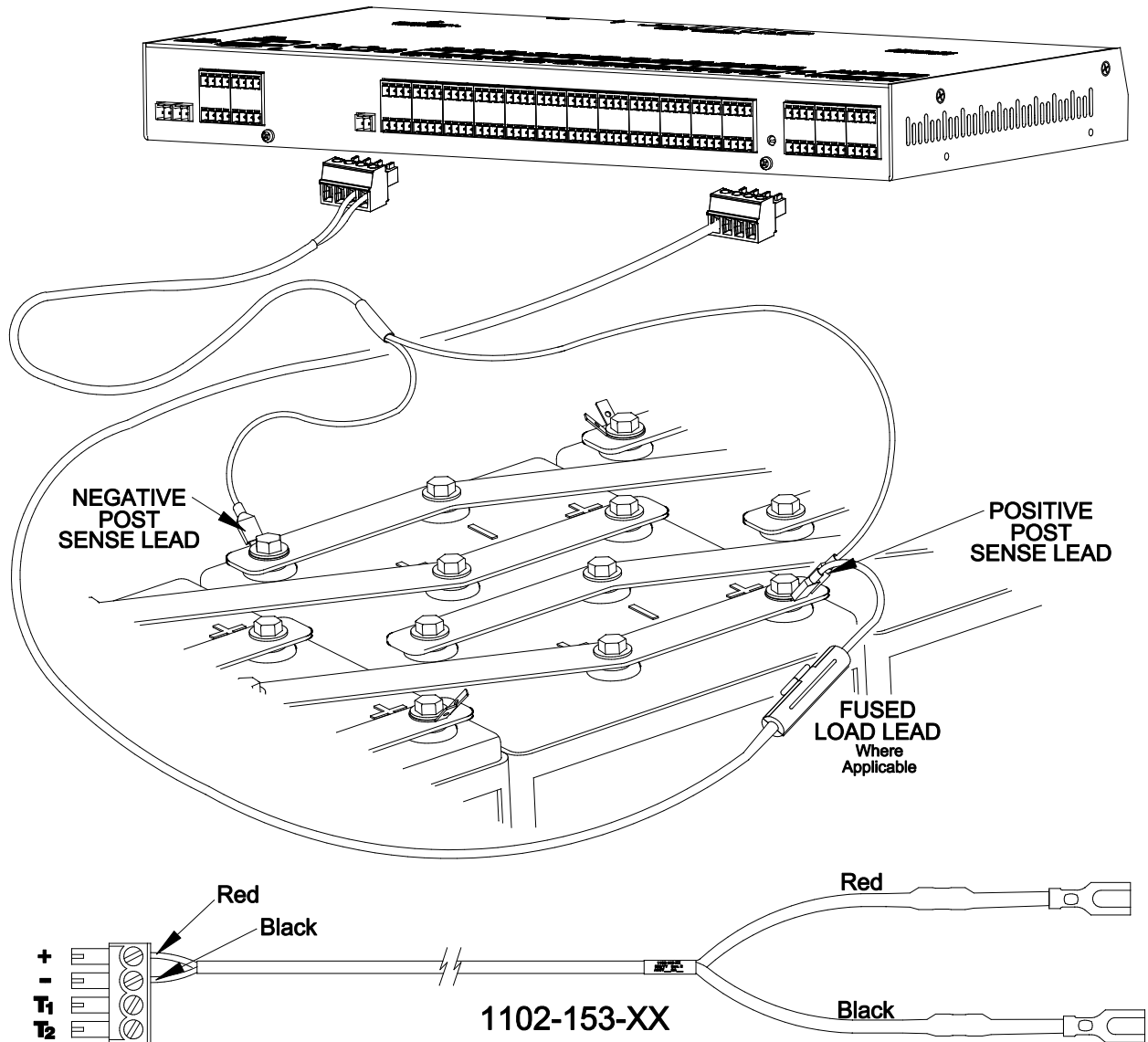

Figure 13 - Exposed Dual or Multiple Posts with Wired Tab Washers without Cell Temperature Sensor

Sense Lead Harness Connection

Depending on the battery design, there could be single, double or triple post per polarity. Below is an illustration of how to position the wires for each of these configurations. Establishing the best cross section of the battery for the sense lead placement is the best scenario. In any case, when attaching the leads, being consistent across the installation is most important and will yield the most uniform reading when observing the internal and intercell resistance measurements.

If a load lead is required to be attached, it should be landed on the same position as the sense lead, however, actual placement should adhere to the instructions in [Section 7 – Installation of Tab Washers](#).

If a temperature sensor is required, then place this on one of the open double tabs as illustrated in [Section 10.2 - System with Cell Temperature](#).

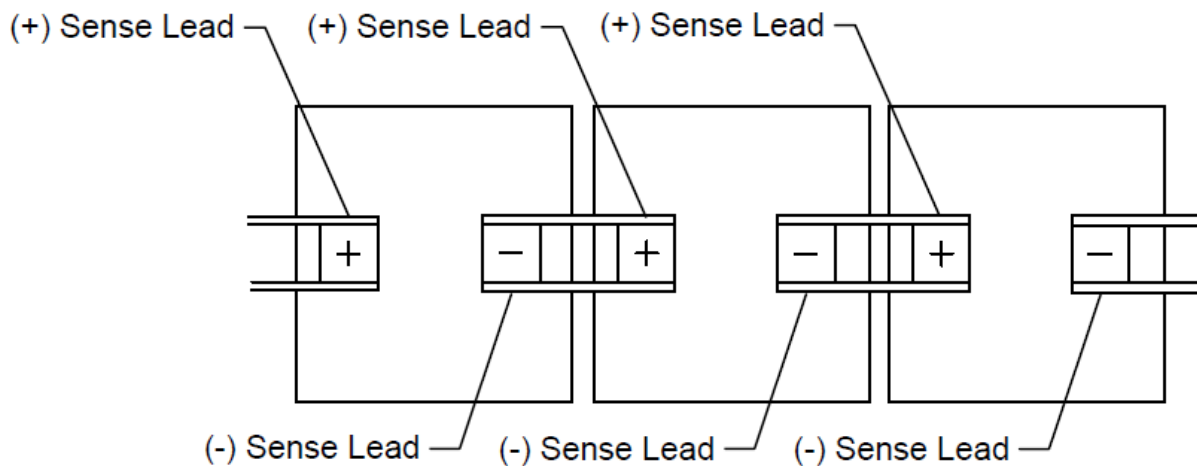

Figure 14 - Single Post Design

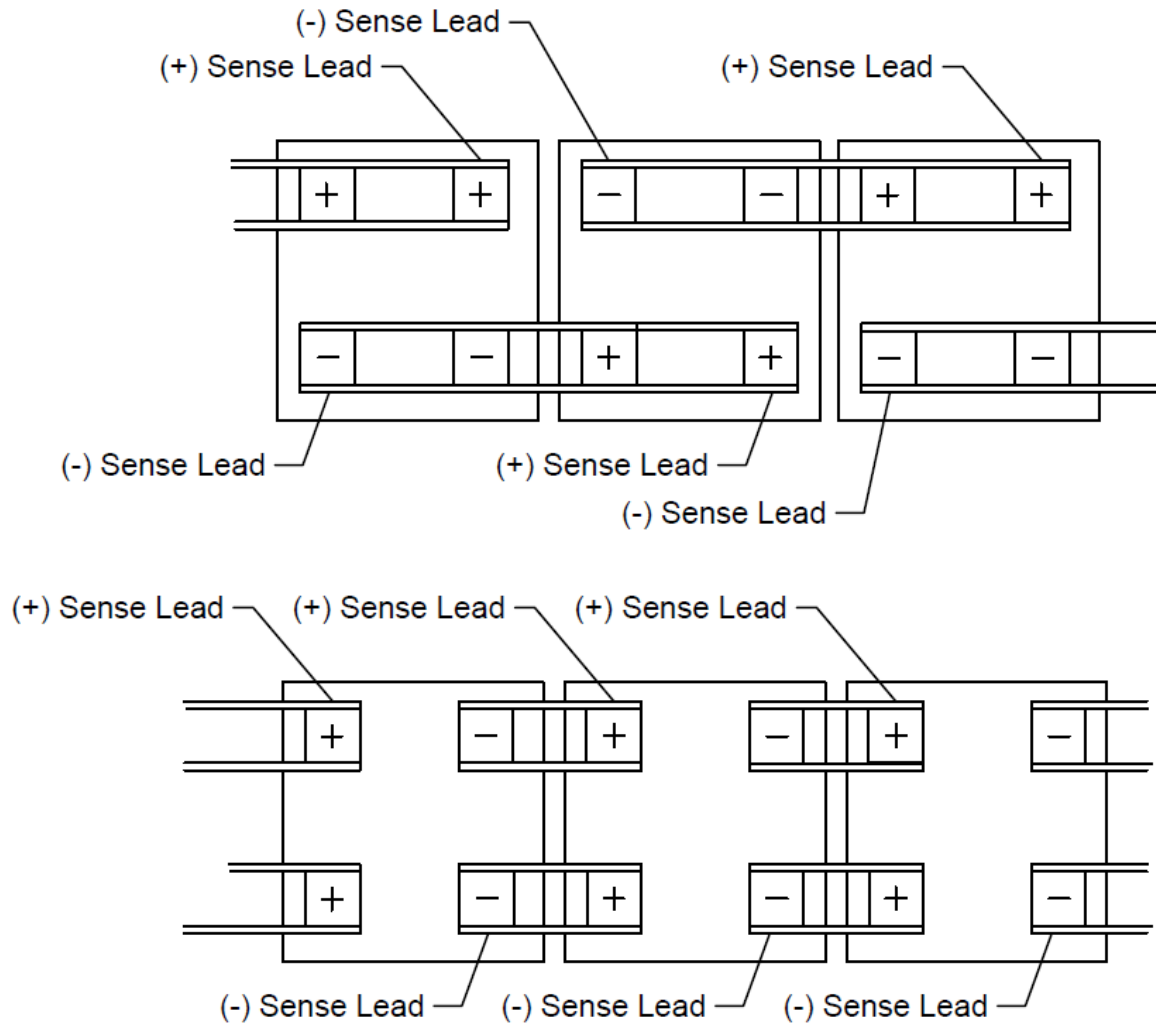

Figure 15 - Double Post Design

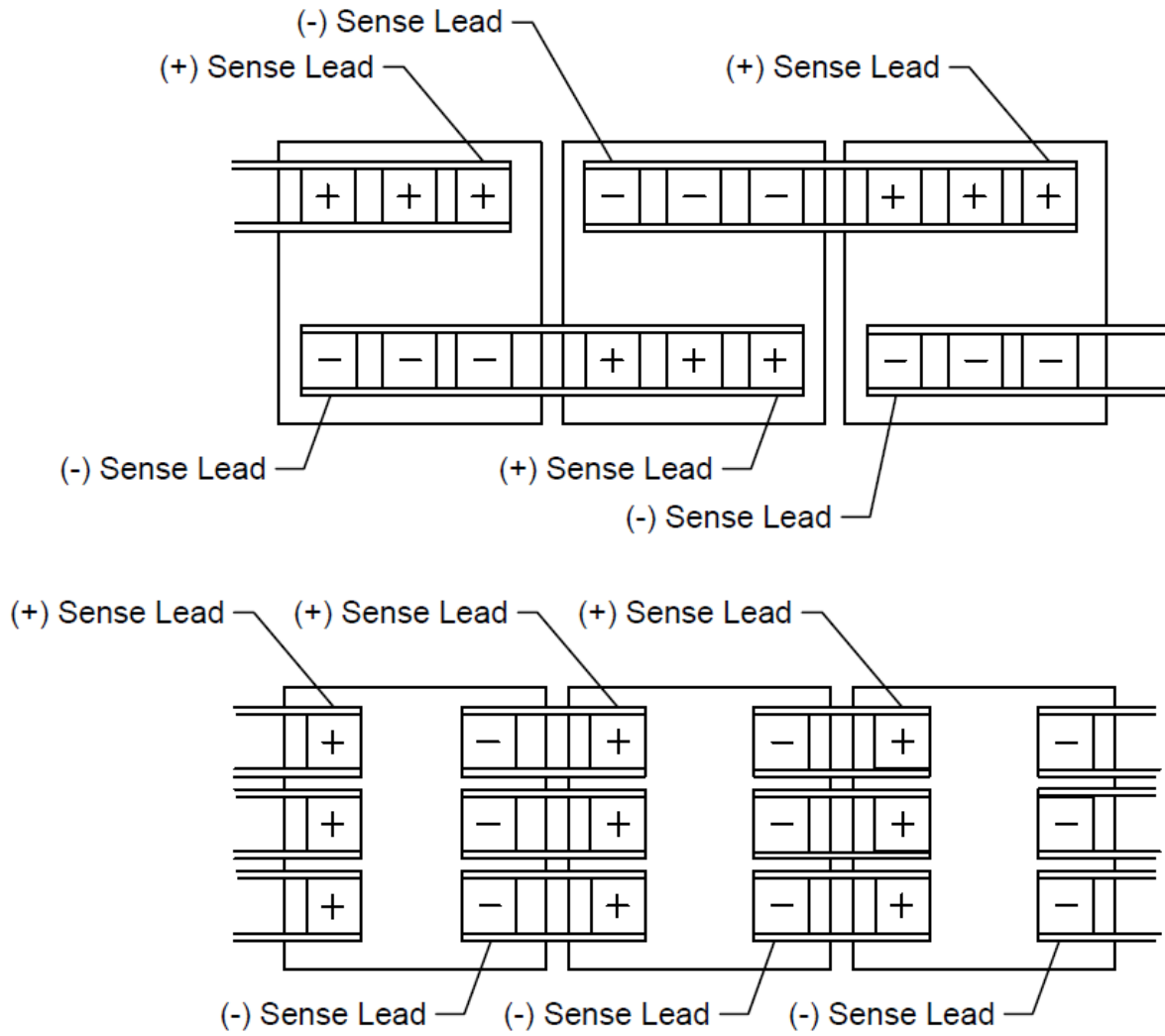



Figure 16 - Triple Post Design

11. Fused Load Lead Harness Connection

There is a maximum of 20 load connections available. The quantity used is dependent on the battery configuration. The installation kit will include the appropriate quantity of harnesses for the configuration ordered. Depending on the configuration, as few as three or as many as twenty load connections will be required. To identify quantities and connection locations, refer to the Load Inputs section of the Configuration Connection Diagram at the back of this manual. Each configuration on this drawing shows exactly where these cables connect to the battery. Sometimes this connection will be made on one of the tabs of a double tab washer and, at other times, it will be positioned on a single tab. It is critical in cases where it is used on a single tab that the load connection be placed closest to the battery post.

Before installation, verify that the fuse is not installed. The fuse will be installed at time of startup. As the cables are routed and inserted into the connector on the rear of the unit, apply a number label that associates the cable to the proper Load Input connection. Proper location and termination of these cables is critical and could cause equipment failures if done improperly.

 **Note:** When installing load lead cables, cut them to the appropriate length. Do not coil these cables. Failure to cut cables to the correct length could result in inaccurate readings.

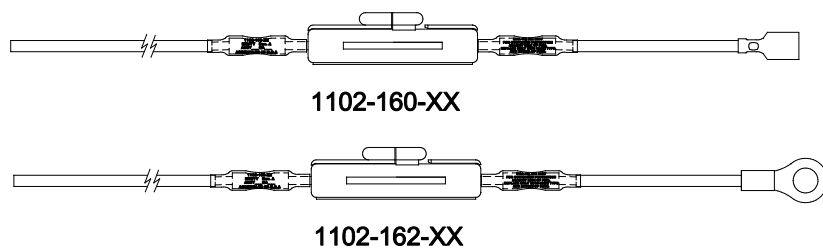

Figure 17 - Fused Load Lead

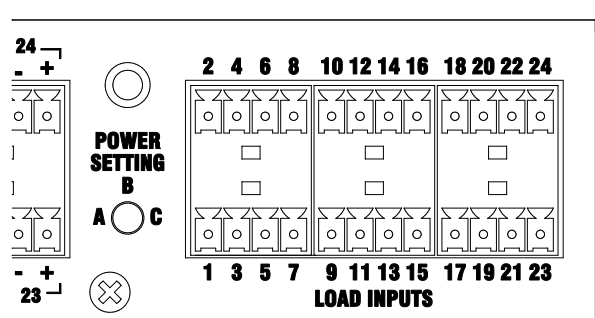





Figure 18 - Load Input Connections

 **Note:** It is very important that the load connection is the closest connection to the post if two tab washers are used. Failure to do this could result in inaccurate resistance readings.

 **Caution:** Connecting the load wires incorrectly could cause an equipment failure if a resistance test is performed. Such failures are not covered under warranty.

 **Warning:** Do not install load lead fuses until instructed to do so in the Getting Started Guide.

12. Ambient Temperature Sensor Connection

There is one ambient temperature sensor included with each unit. This sensor comes with a prefabricated harness with 12', 25' or 50' of cable. Route the cable to the desired location and plug the connector into the rear of the unit.

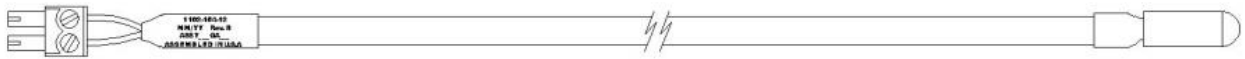

1102-154-XX

Figure 19 - 12', 25' or 50' Temperature Harness

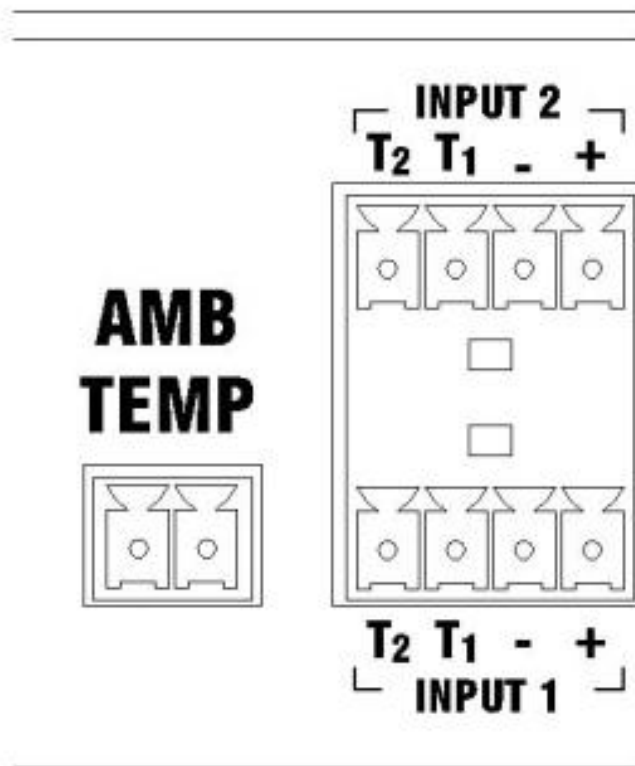

Figure 20 - Ambient Temperature Input

13. Digital Inputs Connection

There are provisions for three separate digital inputs. These can be configured to operate in two different ways. Refer to Digital Input Configuration section on page 8-1 for configuration details. To connect the device monitored, connect to one of the three inputs located on the rear of the unit. If only a switch "open/close contact" mode is being used, then polarity is not important. However, if a voltage source is being used, then the polarity will need to be correct.

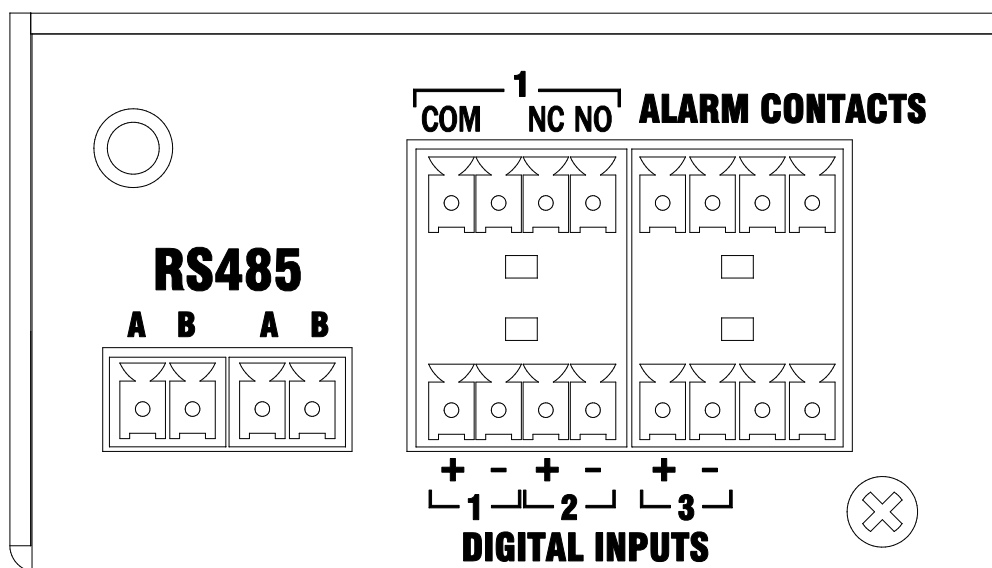

Figure 21 - Digital Inputs



Caution: Pay close attention to polarity and voltage when making these connections. Connecting the digital inputs polarity backwards or exceeding 60Vdc in voltage mode will damage the equipment.

14. RS-485 Communication Connection

Communication between the UXTM and remote controllers is accomplished through the RS-485 port. The unit has four RS-485 terminals. When multiple units are used together or with another remote controller, these modules can be networked together using the RS-485 terminals.

Note: Each slave device on the RS-485/Modbus network must have a unique address. This address is set from the General tab under Setup in the UXTM Configurator application.

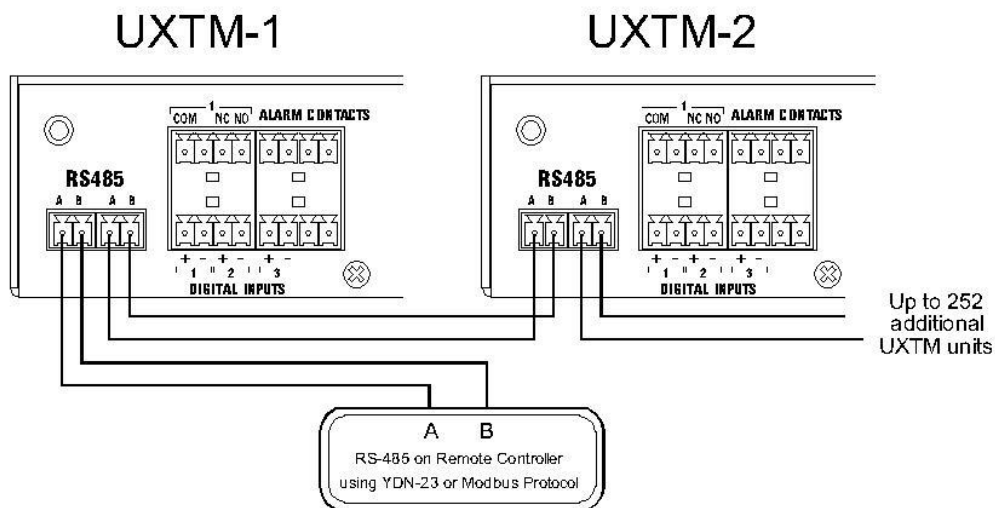

Figure 22 - RS-485 Connections

The recommended baud rate of 9600 should work in most cases. If intermittent communications are experienced, using a lower baud rate usually will correct this. Available baud rates are 1200, 2400, 4800, 9600, and 19200. If intermittent communications still exist after adjusting the baud rate, the termination jumper must be inserted on the last unit on the bus. By default, these jumpers are installed and therefore must be removed on units connected previous to the last unit on the bus. Refer to Unit Configuration, section 8.2 for additional details.

15. Fiber Optic Communication Connection

The Fiber Optic ports are an optional communications port used to connect to a BDSU Linker module - UXCM. When integrated with a UXCM, the UXTM will inherit a host of advanced features outlined in the BDSU Product Description Guide.

To connect to a UXCM, use the supplied fiber optic cable (if option is installed) and connect the TX of the UXCM to the RX of the UXTM and then the TX of the UXTM to the RX of the UXCM.

When cutting the fiber optic cable to length, the ends must be properly cut and polished to achieve reliable communications. Follow the instructions supplied with the polishing kit.

When routing and terminating the fiber optic cable, the following should be considered.

- The minimum bend radius should not be less than 35mm or 1.4"
- The maximum length between modules cannot exceed 250' or 76 meters. Exceeding 250' will cause degradation in the signal which will manifest itself as intermittent or no communications.

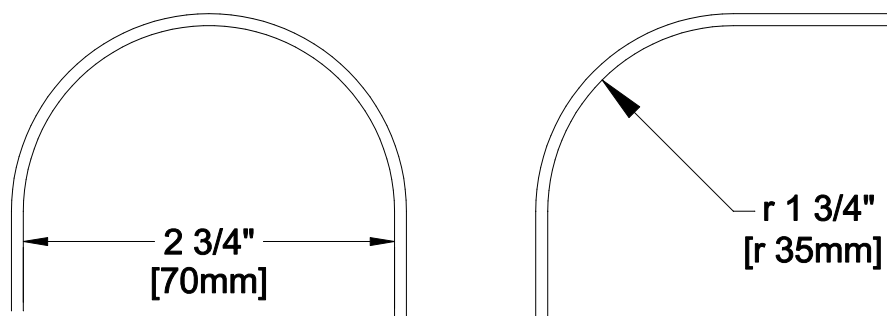
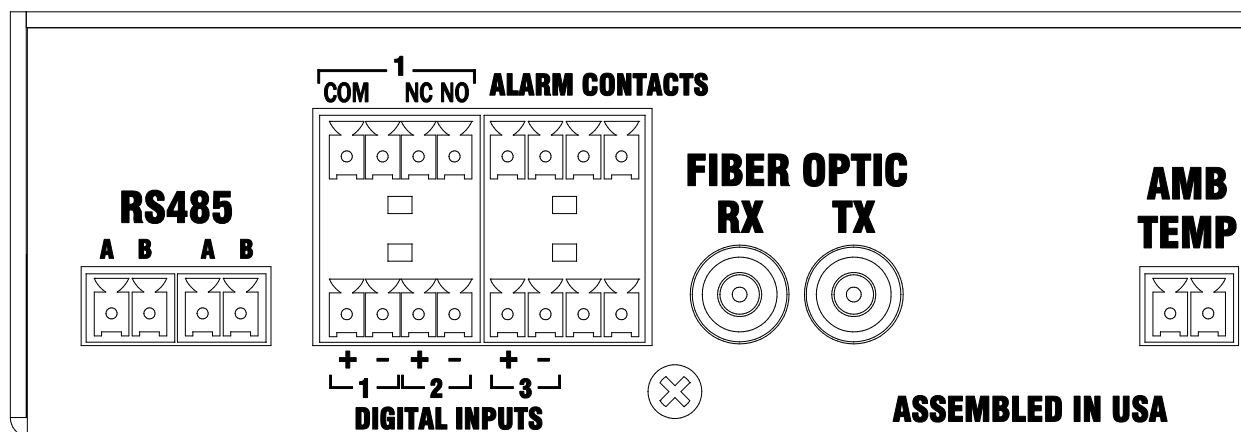

Diagram Not To Scale

Figure 23 - Minimum Fiber Optic Bend Radius

16. Network Communication Connection

The LAN network connector allows the UXTM to be connected to a Ethernet network. From an existing network, connect the network cable to the LAN connector on the UXTM.

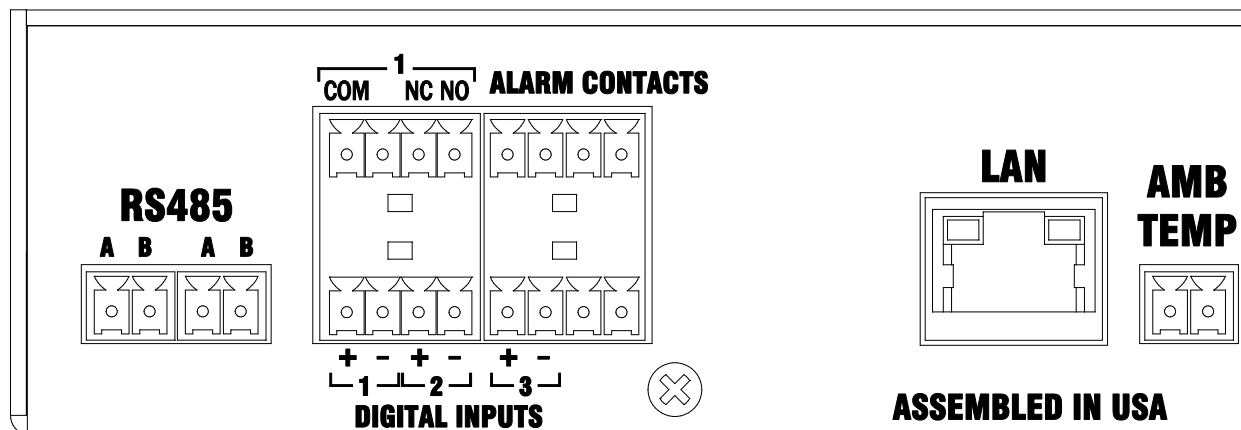

Figure 24 - Network Connection

16.1 Network Protocols Supported

There are several protocols supported by the network interface and will require specific ports to be opened up on the network. The following lists the supported protocols that can be used:

- TCP 502 (Modbus)
- TCP 3002 (Application debug port)
- TCP 9999 (Telnet setup)
- TCP 10001 (TCP to serial pass through)
- UDP 69 (TFTP), only to load code updates
- UDP 161 (SNMP)
- UDP 162 outbound (SNMP traps)

17. Alarm Contact Connection

There is one Form C alarm contact. This contact has three connections: COM (common), NC (normally closed) and NO (normally open). Connection can be made directly to the facility's alarm reporting system. If multiple units are used, then these contacts can be connected in series or parallel, depending on the requirements for the facility's NC or NO.

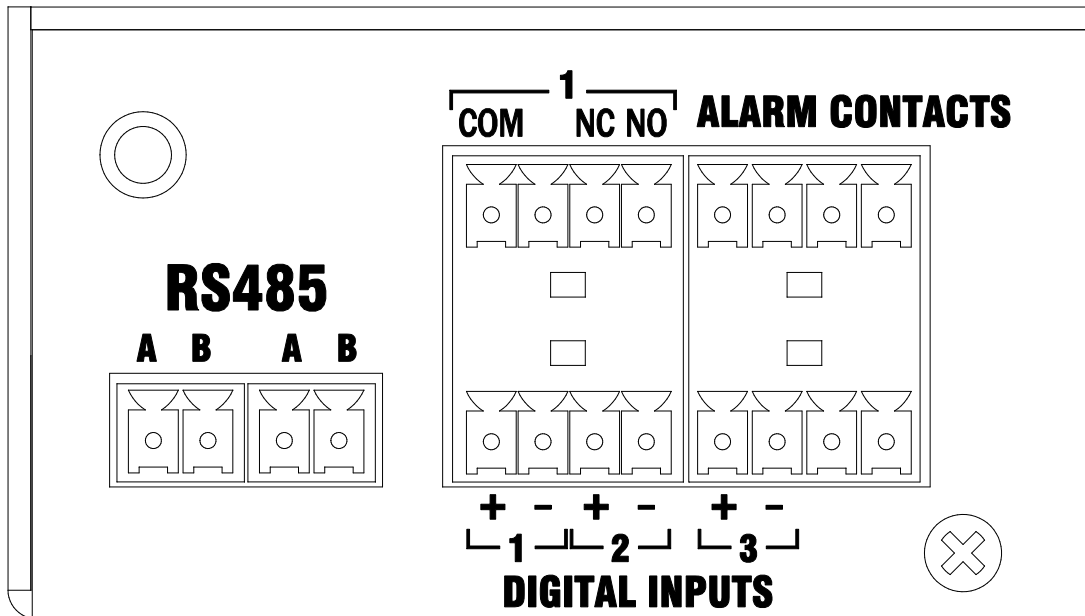

Figure 25 - Alarm Contacts

18. Installing Strain Relief Kit

To complete the wiring installation, install the strain relief kit (KIT-1200-378) which is supplied with your UXTM installation kit. After all wires are connected to the UXTM unit, install the wire routing bracket behind the wire bundle. The alignment groove on the bracket will mate with the tab on the rear of the UXTM unit. Move the bracket into place, lifting the wire bundle and secure the bracket with the supplied mounting screws. The wires should then be routed over the bracket's edge and secured in place using the strain relief bracket as shown in the diagram below.

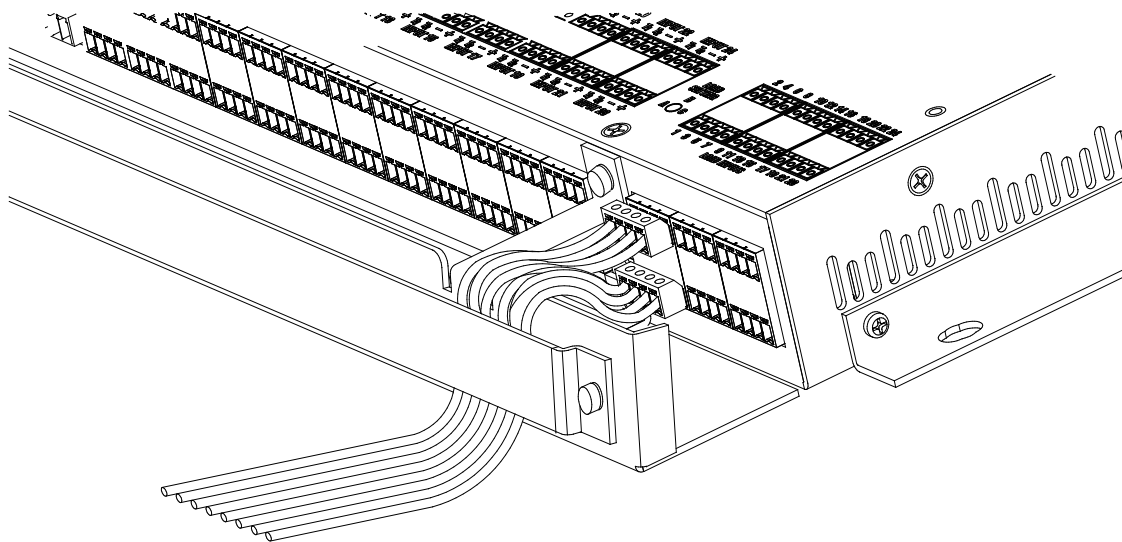
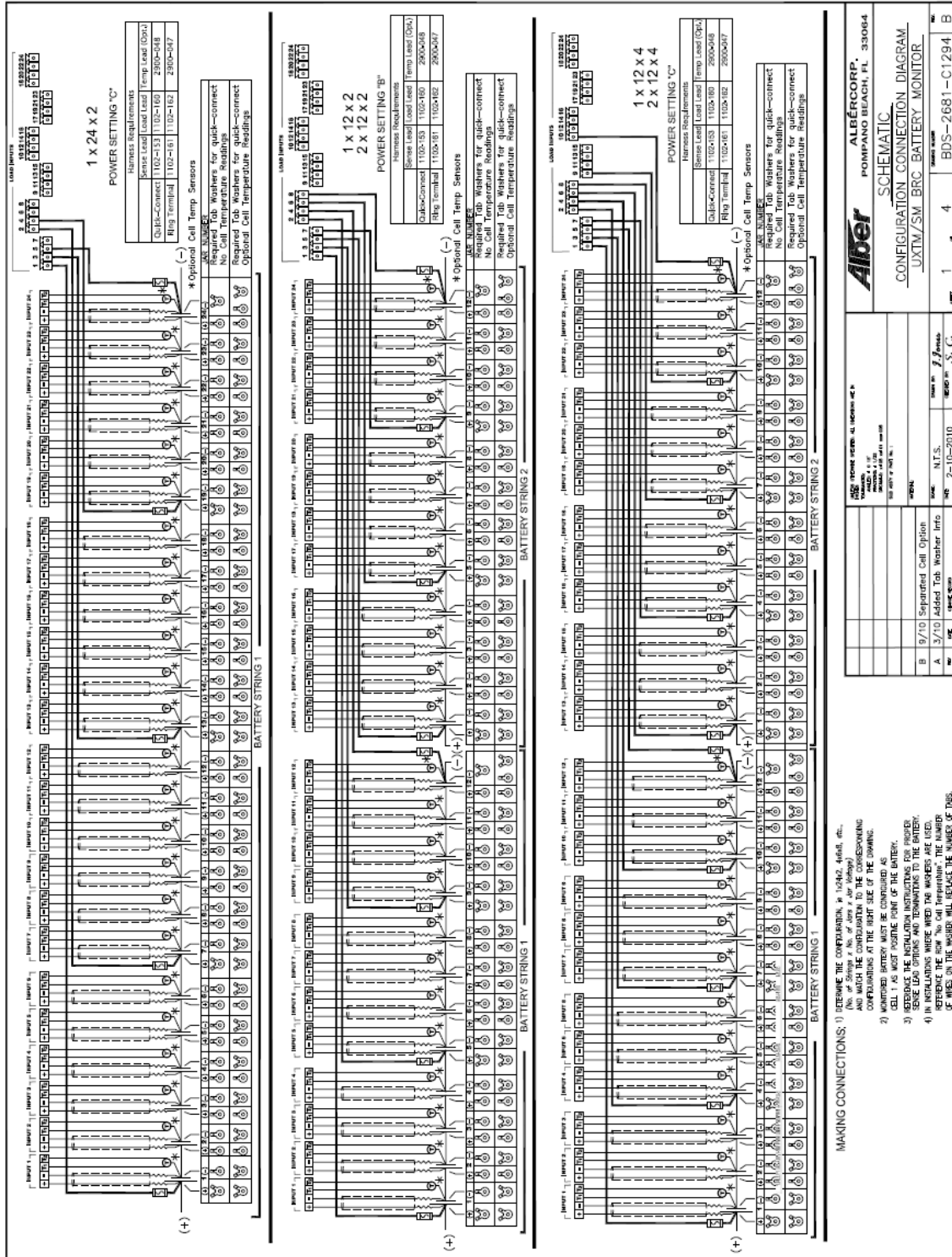
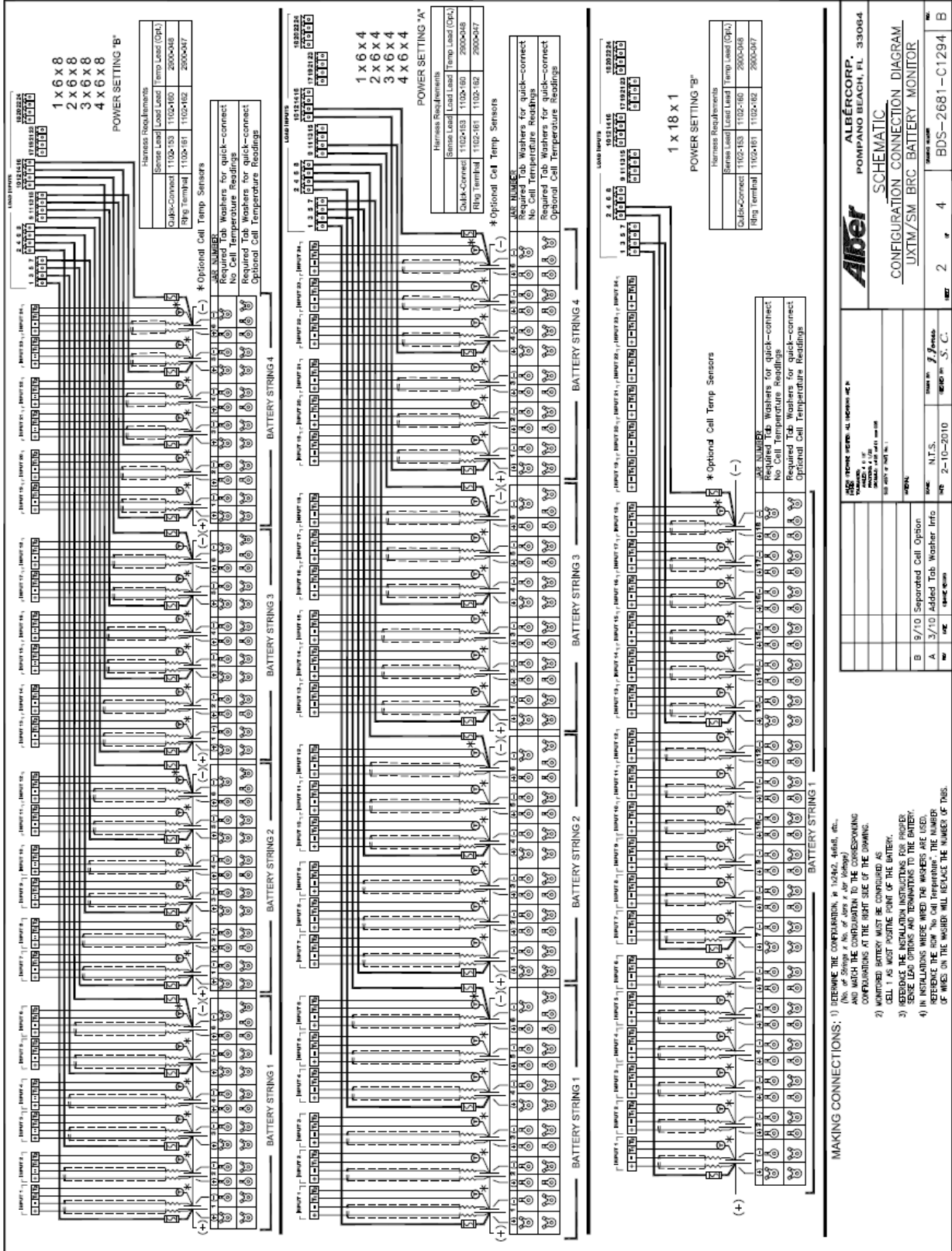

Figure 26 - Installed Strain Relief Kit with Wires Running through Strain Relief Bracket

19. Drawings

The following UXTM drawings are for reference only. A package of full size drawings will be part of the materials received with the UXTM device.





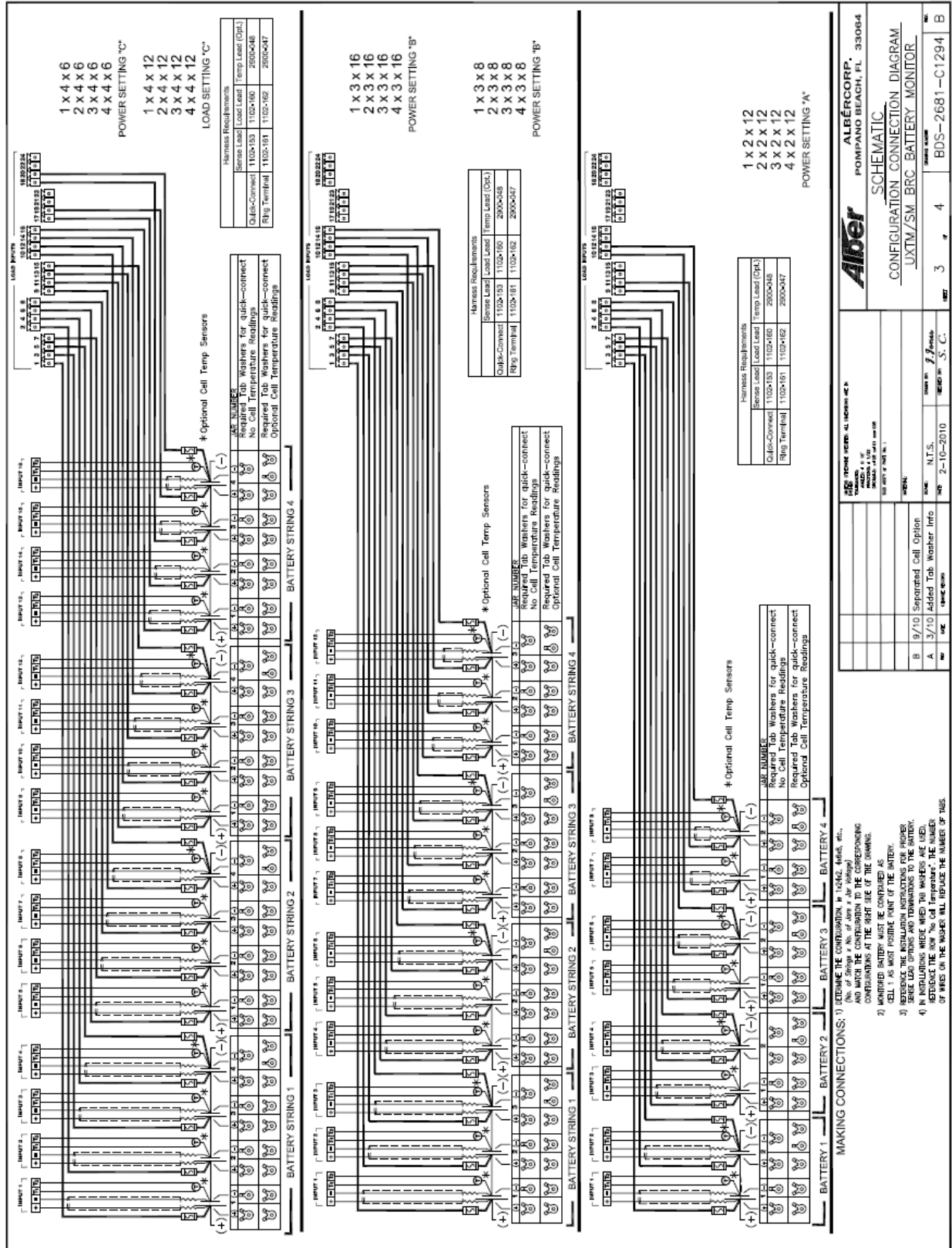

ALBERCORP.
POMPANO BEACH, FL 33064

SCHEMATIC

CONFIGURATION CONNECTION DIAGRAM
LXTM/SM_BRC_BATTERY_MONITOR

REV	DATE	BY	CHKD	APP'D
3	10-20-2010	J. J. J.	S. C.	

20. Index

- 12' Ambient Temperature Sensor 5-2
- 15 AMP SB Fuse 5-2
- 4 Pin Connector for Terminating Harnesses 5-2
- Alarm Contact Connection 17-1
- Ambient Temperature Input 12-1
- Ambient Temperature Sensor Connection 12-1
- Battery Configuration 8-3, 8-4
- Battery String Isolation 6-2
- Cable Number Labels 5-2
- Caution 1-1
- Cell/Monobloc Number 1 Identification 6-2
- Digital Input
 - Channel 8-1
 - Configuration 8-1
 - Jumpers 8-1
 - Modes 8-1
- Digital Inputs Connection 13-1
- Dual Posts 10-5
- Equipment Access 1-2
- Equipment Grounding 1-2
- Equipment Location 6-1
- Equipment Mounting 9-1
- Equipment Service 1-2
- Fiber Optic Connection 15-1
- Fused Load Lead 11-1
- Fused Load Lead Harness Connection 11-1
- Fuses 1-2
- Installation
 - Task List 4-1
- Insulation Rating For Wires 1-3
- Internal Component Replacement 2-1
- Load Input Connections 11-1
- materials
 - standard 5-2
- Materials Received List 5-1
- Mounting Options 6-1
- Multiple Positive and Negative Posts 10-5
- Network Protocols 16-1
- Note 1-1
- Operating Damaged Equipment 1-2
- Part Number
 - 3703-006-fiber optic cable 5-1
 - KIT-3703-015-fiber optic polishing kit 5-2
- Power Setting 8-3, 8-4
- Power Setting Selection 8-3
- Power Settings Switch Location 8-4
- Preventive Maintenance 2-1
- Product Safety Practices 1-2
- Protocols 16-1
- Rack Mounting 9-1
- Rack Mounting Kit 5-2
- Recessed Post
 - Tab Washer Assembly 7-1
- RS-485 Communication Connection 14-1
- RS-485 Termination 8-2
- Safety Information 1-1
- Safety Symbols 1-1
- Sense Lead and Ring Terminal Cleaning 2-1
- Sense Lead Harness 5-1
- Sense Lead Harness Connection 10-1
- Servicing and Adjusting 1-2
- Strain Relief Kit 5-2, 18-1
- Substituting Parts or Modifying Equipment 1-2
- Supported Network Protocols 16-1
- System Component Cleaning 2-1
- System Installation 4-1
- System Overview 3-1
- System with Cell Temperature 10-3
- System Without Cell Temperature 10-1
- Tab Washers
 - Installation 7-1
- Temperature Harness
 - 12 foot 12-1
- Ventilation 1-3
- Visual Inspection 2-1
- Wall Mounting 9-1
- Wall Mounting Kit 5-2
- Warning 1-1
- Wire Length 6-1