



Liebert<sup>®</sup> iCOM<sup>™</sup>

## **Installer/User Guide**

**Intelligent Communication and Monitoring for CW, CWA, DS, DSE,  
PDX/PCW**

The information contained in this document is subject to change without notice and may not be suitable for all applications. While every precaution has been taken to ensure the accuracy and completeness of this document, Vertiv assumes no responsibility and disclaims all liability for damages result from use of this information or for any errors or omissions.

Refer to local regulations and building codes relating to the application, installation, and operation of this product. The consulting engineer, installer, and/or end user is responsible for compliance with all applicable laws and regulations relation to the application, installation, and operation of this product.

The products covered by this instruction manual are manufactured and/or sold by Vertiv. This document is the property of Vertiv and contains confidential and proprietary information owned by Vertiv. Any copying, use, or disclosure of it without the written permission of Vertiv is strictly prohibited.

Names of companies and products are trademarks or registered trademarks of the respective companies. Any questions regarding usage of trademark names should be directed to the original manufacturer.

### **Technical Support Site**

If you encounter any installation or operational issues with your product, check the pertinent section of this manual to see if the issue can be resolved by following outlined procedures.

Visit <https://www.vertiv.com/en-us/support/> for additional assistance.

# TABLE OF CONTENTS

<b>1 Getting Started with Vertiv™ Liebert® iCOM™ Installer/User Guide</b>	<b>1</b>
1.1 Touchscreen Display and User Interface	1
1.2 Touchscreen Status Dial	3
1.2.1 Dial Background Color Status Indication	5
1.3 Control Header	6
1.3.1 Powering On the Vertiv™ Liebert® iCOM™ and Logging In/Unlocking Controls	6
1.3.2 Powering On the Thermal Management Unit	7
1.3.3 Powering Off the Thermal Management Unit	8
1.3.4 Logging Out	8
1.3.5 Setting the Date and Time	8
1.3.6 Searching	9
1.4 Using Context Sensitive Help	9
1.5 About Vertiv™ Liebert® iCOM™ Version	9
1.6 Accessing the User, Service, and Advanced Menus	10
1.7 User Menu	10
1.8 Service Menu	11
1.8.1 Service Menu Options	11
1.9 Advanced Menu	12
1.9.1 Advanced Menu Options	12
<b>2 User Operation</b>	<b>15</b>
2.1 Viewing and Editing Setpoints for the Cooling Unit	15
2.1.1 Editing Humidity Setpoints	15
2.1.2 Editing Temperature Setpoints	16
2.2 Viewing Unit Alarms	17
2.2.1 To View Alarms	17
2.2.2 Alarm Detail Fields	18
2.2.3 Silencing an Audible Alarm	18
2.2.4 Acknowledging Alarms	18
2.3 Viewing the Event Log	20
2.4 Viewing Sensor Data	20
2.5 Managing Run Hours for a Component	20
2.5.1 Setting Run Hours to Zero	20
2.6 Viewing Vertiv™ Liebert® EconoPhase Operation	21
2.7 Viewing Teamwork, Standby, and Cascade Status	22
2.7.1 To View the Teamwork Details	22
<b>3 Service Operation</b>	<b>23</b>
3.1 Editing Setpoints for the Cooling Unit	23
3.1.1 Setpoints Options	23
3.1.2 Configuring Temperature Setpoints	24

- 3.13 Temperature Control—Temperature Setpoints and Cooling Operation ..... 27
- 3.14 Compressor Control by Cooling Requirement ..... 29
- 3.15 Setting Temperature Compensation ..... 37
- 3.16 Fan Temperature Compensation ..... 37
- 3.17 Configuring High/Low Limit Setpoints ..... 39
- 3.18 Configuring Humidity Setpoints ..... 40
- 3.19 Humidity Control ..... 42
- 3.110 Configuring Fan Setpoints ..... 43
- 3.111 Manual Fan Speed Control ..... 45
- 3.112 Automatic Fan Speed Control ..... 47
- 3.113 Configuring Static Pressure Setpoints ..... 47
- 3.114 Supply Sensor Aggregation ..... 49
- 3.2 Scheduling Condenser and Cooling Unit Tasks ..... 50
  - 3.2.1 Scheduling Condenser Low Noise Operation ..... 50
  - 3.2.2 Scheduling Condenser Fan Reversal ..... 51
  - 3.2.3 Scheduling Sleep Times for Thermal Management Units ..... 52
- 3.3 Setting General Thermal Management Unit Options ..... 53
  - 3.3.1 Setting Miscellaneous Options ..... 53
  - 3.3.2 Configuring Quick Start ..... 54
  - 3.3.3 Automatic Restart after Power Failure ..... 56
  - 3.3.4 Setting Fan Options ..... 56
  - 3.3.5 Setting Compressor Options ..... 58
  - 3.3.6 Setting Reheat Options ..... 60
  - 3.3.7 Reheat Control ..... 61
  - 3.3.8 Setting Humidifier Options ..... 65
  - 3.3.9 Setting Dehumidification Options ..... 66
  - 3.3.10 Setting Water Leak Detector Options ..... 67
  - 3.3.11 Setting Q15 Options ..... 67
  - 3.3.12 Temperature Control: Setting Loss of Cooling Operation ..... 69
- 3.4 Vertiv™ Liebert® Fluid Economizer ..... 70
  - 3.4.1 Differential Temperatures/Controls (Comparator Circuit) ..... 70
  - 3.4.2 Vertiv™ Liebert® Air Economizer ..... 73
- 3.5 Vertiv™ Liebert® Air Economizer Operation ..... 75
  - 3.5.1 Liebert® Air Economizer System Overview ..... 76
  - 3.5.2 Disable the Vertiv™ Liebert® Air Economizer ..... 79
  - 3.5.3 Adjust the Restricted Airflow Switch on the Vertiv™ Liebert® Air Economizer ..... 80
- 4 Managing Events: Alarms, Warnings and Messages ..... 81**
  - 4.1 Event Properties ..... 81
    - 4.1.1 Alarms and Events Panel Fields ..... 81
  - 4.2 Enabling Events and Editing Event Settings ..... 82
  - 4.3 Selecting Event Type and Setting Alarm/Warning Notification ..... 83



4.3.1 Notification Properties .....	83
4.4 Enabling the Audible Alarm Notification .....	92
4.5 Remote Alarm Device and Customer Input Events .....	92
4.5.1 Setting Up Customer Input Events .....	92
<b>5 U2U Networking .....</b>	<b>97</b>
5.1 Preparing for U2U Group Set Up .....	97
5.2 Configuring U2U Network Settings .....	98
5.2.1 U2U Control Board Settings .....	99
5.2.2 Troubleshooting Network Settings Issues .....	100
5.2.3 Modifying U2U Network Settings .....	100
<b>6 Teamwork, Standby and Rotation for Cooling Units .....</b>	<b>101</b>
6.1 Continuous Control with Virtual Master .....	101
6.2 Teamwork Modes .....	101
6.2.1 To Set Up Teamwork .....	101
6.2.2 No Teamwork—Multiple Zones in One Room .....	104
6.2.3 Teamwork Mode 1—Parallel Operation .....	104
6.2.4 Teamwork Mode 2—Independent Operation .....	105
6.2.5 Teamwork Mode 3—Optimized Aisle Operation .....	105
6.3 Assigning Cooling Units to Standby (Lead/Lag) .....	106
6.3.1 To Set Up Lead/Lag Operation .....	106
6.4 Setting a Rotation Schedule .....	107
6.4.1 Unit Rotation Options .....	107
6.4.2 Manually Rotating the Operating and Standby Units .....	108
<b>7 Configuring Economizer Operation .....</b>	<b>109</b>
7.1 Fluid Economizers .....	109
7.1.1 Fluid Economizer Control Options .....	109
7.1.2 Overriding the Fluid Economizer Operation .....	110
7.1.3 Setting Up Fluid Economizer Operation .....	110
7.1.4 Temperature Control with a Fluid Economizer .....	112
7.1.5 Viewing Fluid Economizer Statuses .....	115
<b>8 External Monitoring and Building Management Systems .....</b>	<b>117</b>
8.1 BMS and Vertiv™ Liebert® IntelliSlot™ Settings .....	117
8.1.1 Configuring BMS Communication with Embedded Unity .....	117
8.1.2 Setting BMS Control Settings .....	118
8.1.3 Setting BMS Backup Setpoints .....	119
8.2 Communication Setup with Embedded Unity .....	120
8.2.1 Connecting to the BMS .....	120
8.2.2 Embedded Unity User and Password .....	124
8.2.3 Unity Restart and Restore Defaults .....	124
8.2.4 System Configuration .....	124
8.2.5 Local Users Configuration .....	126

8.2.6 Network Configuration .....	127
8.2.7 Web Server Configuration .....	129
8.2.8 Remote Services Configuration .....	132
8.2.9 Velocity Protocol Configuration .....	135
8.2.10 Messaging Configuration .....	136
8.2.11 BACnet Protocol Setup .....	141
8.2.12 Modbus Protocol Setup .....	144
8.2.13 SNMP Protocol Setup .....	146
8.3 Unity Status Readings .....	150
8.4 Unity Support Information .....	151
8.4.1 Configuring Active Networking Settings .....	152
<b>9 Configuring Auxiliary Devices .....</b>	<b>155</b>
9.1 Power Monitoring .....	155
9.1.1 Power Monitoring Device Options .....	155
9.2 Fluid Temperature Monitoring .....	156
9.2.1 Fluid Sensor options .....	156
9.3 Configuring Analog Input Devices .....	157
9.4 Wired Remote Sensors .....	157
9.4.1 Wired Remote Sensor Setup Options .....	158
9.4.2 Wired Remote Sensor Sensor Property Options .....	159
9.5 Supply Sensors .....	160
<b>10 Administering Firmware, Settings and Security .....</b>	<b>161</b>
10.1 Vertiv™ Liebert® iCOM™ Firmware Upgrades .....	161
10.1.1 Compatibility with Earlier Versions of Vertiv™ Liebert® iCOM™ .....	161
10.1.2 Updating Vertiv™ Liebert® iCOM™ Control Board Firmware .....	161
10.1.3 Reverting to Firmware in Dormant Partition .....	163
10.2 Backing Up and Restoring Control Board Settings .....	163
10.2.1 Control Board Back Up and Restore Options .....	163
10.3 Managing Access Permission and Passwords .....	164
<b>11 Performing Diagnostics .....</b>	<b>165</b>
11.1 Cooling Unit Status LED .....	165
11.2 Enabling Manual Mode for Diagnostics .....	165
11.2.1 Disabling Diagnostics Manual Mode .....	166
11.3 Diagnosing Evaporator Fan Issues .....	166
11.3.1 Diagnostics—Evaporator Fan Options .....	166
11.4 Diagnosing Compressor Circuit Issues .....	167
11.4.1 Diagnostics—Compressor Circuit Options .....	167
11.4.2 Resetting High Pressure Alarm Code .....	168
11.4.3 Resetting Low Pressure Alarm Code .....	168
11.4.4 Resetting High Temperature Alarm Counter .....	169
11.5 Diagnosing Electronic Expansion Valve Issues .....	169

11.5.1	Diagnostics—Electronic Expansion Valve Options	169
11.5.2	Resetting EEV Battery Failure Counter	170
11.6	Diagnosing Vertiv™ Liebert® EconoPhase Issues	170
11.6.1	Diagnostics—Vertiv™ Liebert® EconoPhase Options	170
11.7	Diagnosing Reheat Issues	171
11.7.1	Diagnostics—Reheat Options	171
11.8	Diagnosing Humidifier Issues	171
11.8.1	Diagnostics—Humidifier Options	172
11.9	Diagnosing Digital Output Issues	172
11.9.1	Diagnostics—Digital Output Options	173
11.10	Diagnosing Analog Output Issues	173
11.10.1	Diagnostics—Analog Output Options	173
11.11	Diagnosing Customer Input Issues	173
11.11.1	Diagnostics—Customer Input Options	173
11.12	Diagnosing Water Leak Detection Issues	174
11.12.1	Diagnostics—Water Leak Detection Options	174
<b>12</b>	<b>Customizing the Vertiv™ Liebert® iCOM™ Display</b>	<b>175</b>
12.1	Setting General Display Properties	175
12.1.1	Unit Display Options	175
12.2	Customizing Main Display Views	176
12.2.1	Moving Content	176
12.2.2	Resizing Content	176
12.2.3	Adding and Adjusting Content	177
12.2.4	Removing Content	178
12.3	Customizing Parameter and Field Labels	178
12.3.1	Exporting, Importing and Customizing Labels Using a Text Editor	180
<b>13</b>	<b>Vertiv™ Liebert® iCOM™ Hardware Installation</b>	<b>181</b>
13.1	Return Air Temperature/Humidity Sensor	181
13.1.1	P67: Return Air Temperature—Humidity Board	181
13.1.2	Jumper P3 CANbus Termination	183
13.2	Installing Wired Remote Sensors	184
13.2.1	Setting DIP Switches and Labeling 2T Sensors	184
13.2.2	Terminating the Last Sensor on the CANbus link	186
13.2.3	Installing 2T Sensors in the Racks to Monitor	189
13.2.4	Connect the CANbus Cable and Ground	191
13.3	Installing a Fluid Temperature Sensor	193
13.4	Installing Supply Control Sensors	195
13.4.1	Installing the Supply Air Temperature Sensor	195
13.4.2	Installing Aggregated Supply Air Temperature Sensors	196
13.5	Installing Analog Input Devices	196
13.6	Installing the U2U Network	197

13.6.1 Required Network Equipment .....	197
13.6.2 Plan Wiring Runs .....	197
13.6.3 U2U Wiring Connections .....	197
13.6.4 Wiring Cooling Units without Wall Mount Displays .....	198
13.6.5 Wiring Cooling Units with Wall Mount Displays .....	201
<b>Appendices .....</b>	<b>203</b>
Appendix A: Technical Support and Contacts .....	203
Appendix B: Setpoints and Alarm Settings by Line ID .....	205
Appendix C: Communication Protocol .....	229

# 1 Getting Started with Vertiv™ Liebert® iCOM™ Installer/User Guide

The Vertiv™ Liebert® iCOM™ offers the highest capability for unit control, communication, and monitoring of Liebert thermal management units. It is available factory installed on new units and assemblies or may be retrofitted in existing units.

## 1.1 Touchscreen Display and User Interface

The Vertiv™ Liebert® iCOM™ touchscreen and user interface speeds set up and installation and simplifies control of Liebert thermal management units, literally putting cooling system monitoring and management at your fingertips.

- The resistive touchscreen is used with a firm touch, or consider using a stylus when interacting with the touchscreen.
- User and service menus are password protected to prevent unauthorized changes to cooling unit operation.
- The touchscreen is back lit and auto-dims after a period on non-use, then turns off. Touch the screen to illuminate the main screen.
- Liebert® iCOM™ ships with default settings for efficient and effective operation of most cooling-units and is easily configured to meet any need.
- Liebert® iCOM™ menus and displays are based on the options installed on the cooling units that it monitors and manages.

Figure 1.1 Vertiv™ Liebert® iCOM™ Main Display

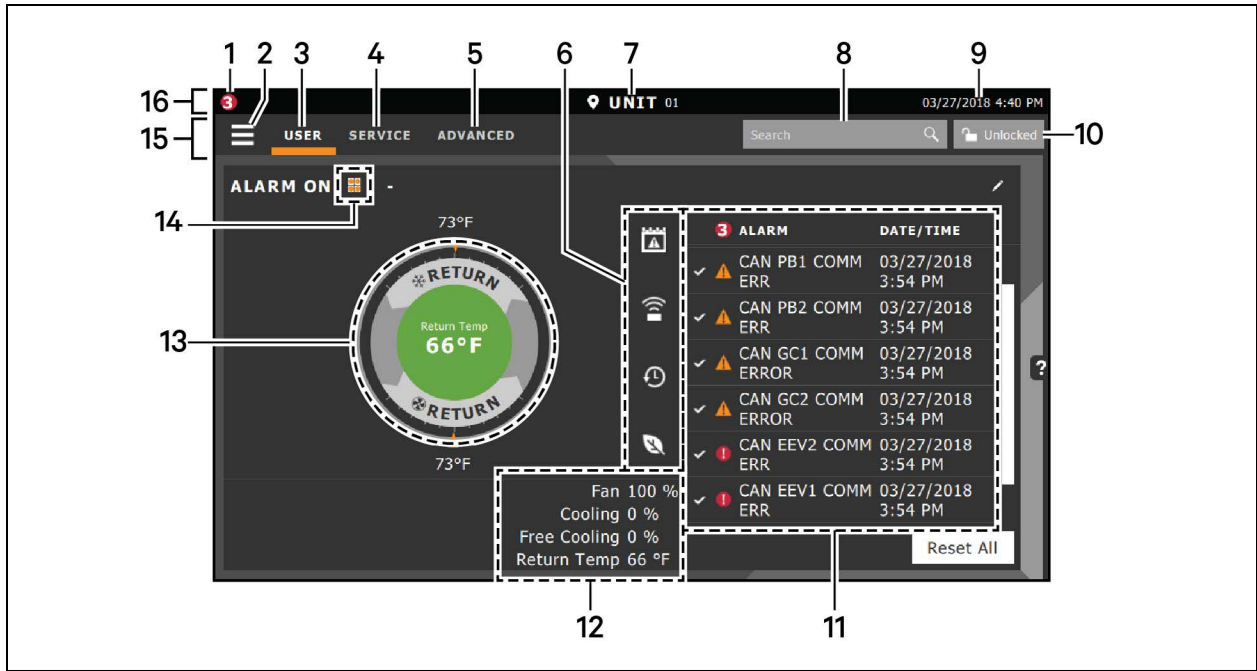

Table 1.1 Main Display Controls and Options

Item	Description
1	Alarms present. Displays the number of active alarms.
2	Menu icon. When unlocked, displays a menu for user or service options depending on which icon is selected.
3	User icon. When selected, the user options are available on the main display and menu. <b>NOTE: You must unlock the display with the User PIN to access the menu and options.</b> See <a href="#">Powering On the Vertiv™ Liebert® iCOM™ and Logging In/Unlocking Controls</a> on page 6 .
4	Service icon. When selected, the service options are available on the main display and menu. <b>NOTE: You must unlock the display with the Service PIN to access the menu and options.</b> See <a href="#">Powering On the Vertiv™ Liebert® iCOM™ and Logging In/Unlocking Controls</a> on page 6 .
5	Advanced icon. When selected, the advanced options are available on the main display and menu. <b>NOTE: You must unlock the display with the Service PIN to access the menu and read-only options.</b> See <a href="#">Powering On the Vertiv™ Liebert® iCOM™ and Logging In/Unlocking Controls</a> on page 6 .
6	Cooling-unit parameters. Status display of selected system parameter settings. See <a href="#">Adding and Adjusting Content</a> on page 177
7	Unit Identification. You may customize the unit name up to six characters/numbers.
8	Search icon. Open the keyboard to search for controls and setting locations. See <a href="#">Searching</a> on page 9 .
9	Date/Time.
10	Lock/Unlock icon. Indicates whether or not the user and service options are accessible. <ul style="list-style-type: none"> <li>Locked icon: display is read-only</li> <li>Unlocked icon: user or service is logged-in and options are accessible.</li> </ul> See <a href="#">Powering On the Vertiv™ Liebert® iCOM™ and Logging In/Unlocking Controls</a> on page 6 .
11	Secondary content panel. When accessing settings/configuration via the menus, the settings display in the right, secondary panel.

**Table 1.1 Main Display Controls and Options (continued)**

Item	Description
12	Summary of current unit function. You can customize to show fan speed, cooling, percentages from any installed device, and any physical (sensor) values.
13	Status Dial. Circular display of setpoints and environmental conditions of the unit. See <a href="#">Touchscreen Status Dial</a> below .
14	Teamwork mode icon. In a panel with Status content, the Teamwork Mode icon indicates the mode selected. For details and descriptions of the teamwork controls, see <a href="#">Teamwork Modes</a> on page 101
15	Control header. Controls to access the user and service menus. See <a href="#">Control Header</a> on page 6 .
16	Status Header. Displays the alarm status, unit identification, and the current date and time.

## 1.2 Touchscreen Status Dial

The dial in the primary control panel displays read-only control sensors, setpoints, and environmental conditions for unit status at a glance. See **Figure 1.2** on the next page .

The center of the dial displays sensor readings and changes color according to alarm thresholds as the readings rise and fall, see [Dial Background Color Status Indication](#) on page 5 .

Touching the center of the dial cycles through a set of sensor settings, and you can select the readings displayed, see [Adding and Adjusting Content](#) on page 177 .

Figure 1.2 Dial Sections

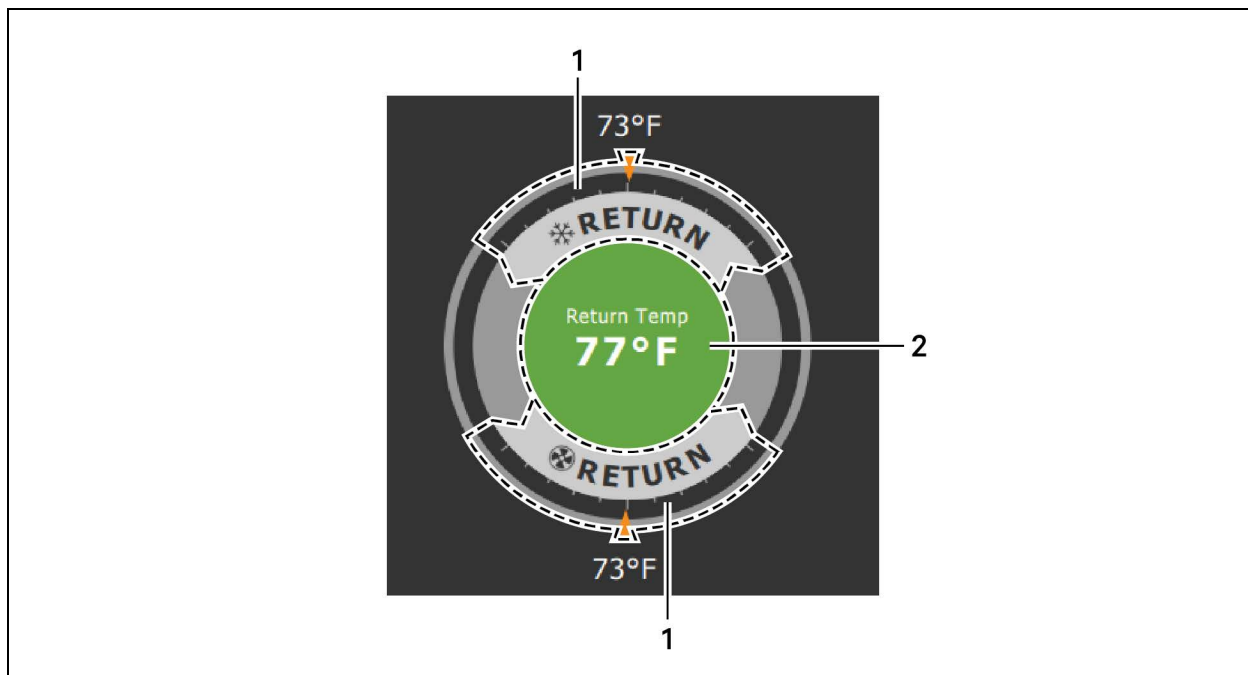

Table 1.2 Dial Sections

Item	Description
1	Control sensor and its setpoint. The sensors and setpoints displayed depend on the configuration of your unit. You may see only temperature-control, or if the unit includes humidity control, that displays on the dial as well. If the sensor selected for fan control is the same as that selected for temperature control, the dial displays the fan control sensor and setpoint, as shown in <b>Figure 1.2</b> above.
2	Single or multiple sensor readings. Cycle through readings by touching the displayed reading.



### 1.2.1 Dial Background Color Status Indication

The background color of the dial indicates whether or not the unit is powered on, and it also responds to threshold settings of the control sensor reading. See **Figure 1.3** below. **Table 1.3** on the next page describes the background color displayed if the selected sensor reading has threshold limits set.

**Figure 1.3** Dial Background Colors

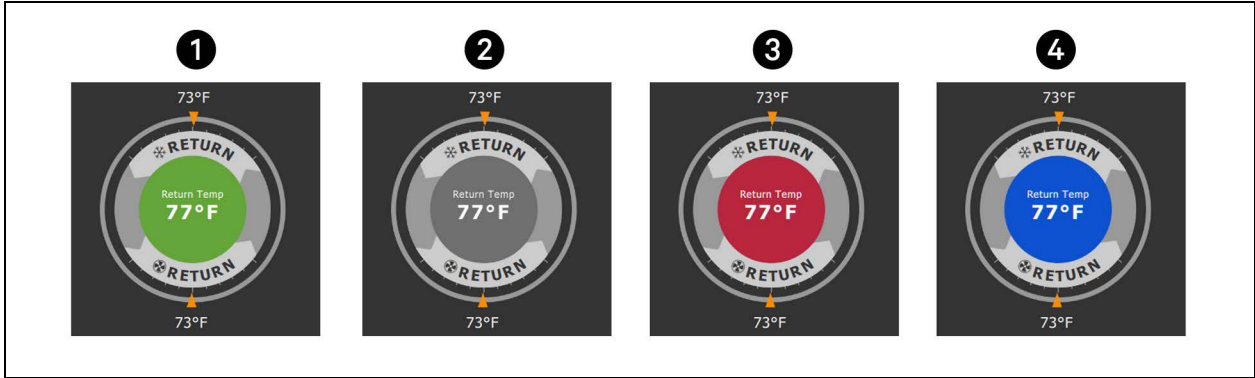

Item	Description
1	Sensor reading is within threshold limits.
2	Unit is powered off.
3	Sensor reading is above threshold limit or the unit is in an alarm condition.
4	Sensor reading is below threshold limit.

**Table 1.3** Background Color Displayed by Selected Value and Threshold Limit

Sensor/Value Selected	Threshold Limit	Background Color
Return Temp	None	Blue
	High return temperature	Red
Return Humidity	Low return humidity	Blue
	High return humidity	Red
Dew Point	Low dew point	Blue
	High dew point	Red
Supply Temp	Low supply temperature	Blue
	High supply temperature	Red
Average Rack Temp	Low remote temperature	Blue
	High remote temperature	Red
Max Rack Temp	Low remote temperature	Blue
	High remote temperature	Red

**Table 1.3 Background Color Displayed by Selected Value and Threshold Limit (continued)**

Sensor/Value Selected	Threshold Limit	Background Color
Min Rack Temp	Low remote temperature	Blue
	High remote temperature	Red
Static Pressure	Low static pressure	Blue
	High static pressure	Red
Outdoor Temp	None	Green
Outdoor Humidity	None	Green

### 1.3 Control Header

The control header contains the controls to access the user and service settings. The display is locked when started initially and when restarted after a period of inactivity.

#### 1.3.1 Powering On the Vertiv™ Liebert® iCOM™ and Logging In/Unlocking Controls

The Vertiv™ Liebert® iCOM™ is powered on when power is switched on at the cooling unit’s disconnect switch and you activate the display by touching it.



Liebert® iCOM™ is locked when started and also locks after a period of inactivity to prevent unauthorized changes. A four digit password is required to access the user and service menus and options, and the advance menu displays as read-only when logged in at the service level.

**NOTE: The factory default inactivity period is one minute. To change the inactivity period, see Customizing Main Display Views on page 176 .**

**NOTE: The factory default password for user and service log in are provided. We recommend you change passwords as necessary to prevent unauthorized changes. See Managing Access Permission and Passwords on page 164 .**

- Default user password: 1490
- Default service password: 5010

To unlock the controls:

1. On the header, touch . The keypad opens.
2. Touch the numbers/characters for your password, then touch . Depending on the password entered and your level of access, the User and/or Service options, and view only access to the Advanced menu are accessible. See [Accessing the User, Service, and Advanced Menus](#) on page 10 .



### 1.3.2 Powering On the Thermal Management Unit

**NOTE:** Depending on the operating state, there are start and stop priority switches that may prevent the cooling unit from operating even though power to the unit is switched on and you have turned it on via Vertiv™ Liebert® iCOM™.

The cooling unit operates only when all switches are closed. For example, even though you have turned on the unit through Liebert® iCOM™, if the BMS remote monitoring system is sending a command to turn off the unit, the cooling unit remains off.

**NOTE:** You must be logged in to access the menu options. See [Powering On the Vertiv™ Liebert® iCOM™](#) and [Logging In/Unlocking Controls](#) on the previous page .

To power-on the unit:

1. Touch , then  > *Turn Unit On*. The TURN UNIT ON dialog opens.
2. Touch *Turn Unit On*. The cooling unit starts and the operating status is displayed as shown in [Figure 1.4](#) below .

**Figure 1.4** Unit Status on Liebert® iCOM™ Display

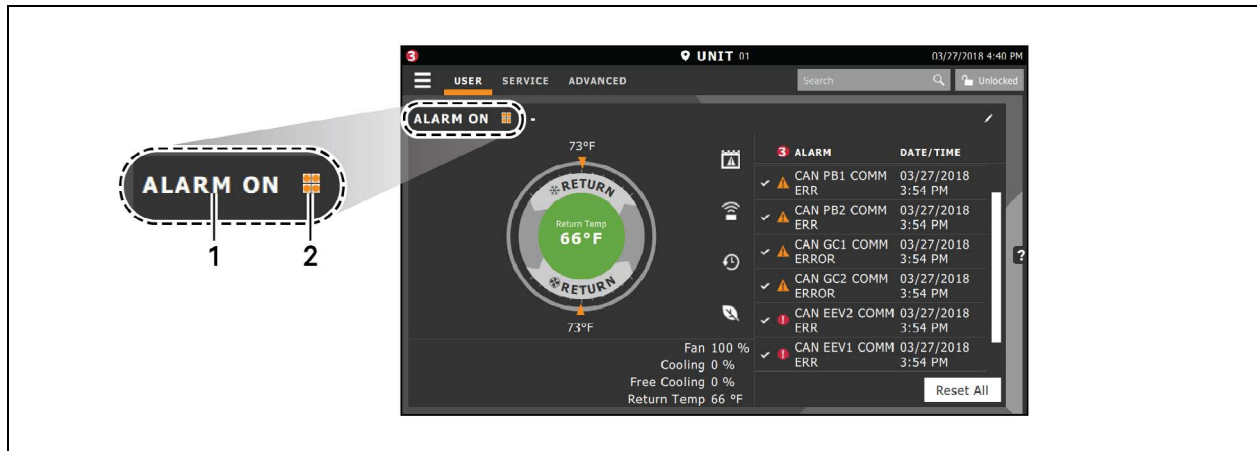

Item	Description
1	Current status of the unit. See <a href="#">Table 1.4</a> on the next page .
2	Teamwork icon. See <a href="#">Viewing Teamwork, Standby, and Cascade Status</a> on page 22 .

**Table 1.4** Cooling Unit Statuses Displayed



Unit Status Text	Description
ALARM OFF	An alarm forced the unit to turn off. See <a href="#">Viewing Unit Alarms</a> on page 17 .
MANUAL	Controlled by a service technician. See <a href="#">Enabling Manual Mode for Diagnostics</a> on page 165 .
DISPLAY OFF	Unit is turned Off at the Liebert® iCOM™ display. See <a href="#">Powering On the Thermal Management Unit</a> above .
ALARM STANDBY	In standby because of an active alarm on the unit. See <a href="#">Viewing Unit Alarms</a> on page 17 .

**Table 1.4 Cooling Unit Statuses Displayed (continued)**

Unit Status Text	Description
STANDBY	In standby because of service-menu setting. See <a href="#">Assigning Cooling Units to Standby (Lead/Lag)</a> on page 106 .
TIMER OFF	Scheduled on a timer and is in sleep mode waiting for the next start interval. See <a href="#">Scheduling Condenser and Cooling Unit Tasks</a> on page 50 .
UNIT ON	Operating normally without alarms or warnings.
WARNING ON	Active warning, but still operating. See <a href="#">Viewing Unit Alarms</a> on page 17 .
ALARM ON	Active alarm, but still operating. See <a href="#">Viewing Unit Alarms</a> on page 17 .
TIMER	Scheduled on a timer to operate, and is in operating mode. See <a href="#">Scheduling Condenser and Cooling Unit Tasks</a> on page 50 .
REMOTE OFF	Turned-off by remote shutdown terminal. Occurs when a normally-closed set of 24V contacts opens. The Remote On/Off and Display On/Off switches are in series, and the cooling unit will only turn-on if both switches are on/closed. If one is off/open, the unit turns off.
MONITORING OFF	Turned-off by remote monitoring system. Check the remote monitoring device or call Vertiv™ technical support for assistance.
BACK-DRAFT	Unit is non-operational, but EC fan is operating as a back-draft damper.
RESTART DELAY	Not yet operational after a power cycle because the restart delay timer is active.

### 1.3.3 Powering Off the Thermal Management Unit

**NOTE:** You must be logged in to access the menu options. See [Powering On the Vertiv™ Liebert® iCOM™ and Logging In/Unlocking Controls](#) on page 6 .

1. Touch  , then  > *Turn Unit Off*. The TURN UNIT OFF panel opens.
2. Touch *Turn Unit Off*. The unit begins a power off countdown then powers off.

### 1.3.4 Logging Out



Log out occurs automatically when the display back light turns off for inactivity.

**NOTE:** The factory default inactivity period is one minute. To change the inactivity period, see [Setting General Display Properties](#) on page 175

- To log out manually, touch the lock icon. The icon indicates locked.

### 1.3.5 Setting the Date and Time

The correct date and time is critical for warnings, alarms, and scheduling.

1. Touch  , then  > *Display Options* > *Display Properties* > *Date & Time*.
2. Touch the date field, use the arrows to select the date, and touch *OK*.  
– or –  
Touch the time field, use the arrows to set the time, and touch *OK*.
3. Select the date and time format if necessary.
4. Touch *Save*.

### 1.3.6 Searching

When logged in, you can use the display search to find the location of settings options based on a term, service code, or parameter. You can also search by the line ID used in the Vertiv™ Liebert® iCOM™ before the touchscreen model. For a listing of the line IDs, see [Setpoints and Alarm Settings by Line ID](#) on page 205 .

**NOTE:** You must be logged in to access the display search. See [Powering On the Vertiv™ Liebert® iCOM™ and Logging In/Unlocking Controls](#) on page 6 .

1. In the control header, touch the search field. The keyboard opens.
2. Type the term and touch . A list of locations that contain the searched term opens.
3. To go to a listed location, touch an item, then touch Go. The panel for the selected location opens.

– or –

To view the service codes and parameter entries related to the searched term, touch View Parameter Directory Entries (the number of related entries is included in the option). The Parameter Directory opens. You may further refine the search in the directory.

## 1.4 Using Context Sensitive Help

Touching the Help icon, , on the right-hand side of the display opens the Help drawer with information about the panel or dialog currently on the display.

You can use search and the topic index to find further information.

To close the Help drawer, touch the close arrow, .

## 1.5 About Vertiv™ Liebert® iCOM™ Version





The version, build, and other firmware information for the Liebert® iCOM™ display board may be helpful when servicing or troubleshooting. To locate the firmware version of the Liebert® iCOM™ control board, see [Updating Vertiv™ Liebert® iCOM™ Control Board Firmware](#) on page 161 .

- Touch , then  > *About*. The ABOUT panel opens.

## 1.6 Accessing the User, Service, and Advanced Menus

Vertiv™ Liebert® iCOM™ operating functions that monitor and control a cooling unit are accessed via the User and Service menus.

**NOTE:** You must be logged in to access the menu options. See [Powering On the Vertiv™ Liebert® iCOM™ and Logging In/Unlocking Controls](#) on page 6 .

1. To access a menu, touch the icon for the menu you want, , , or , in the control header, see [Control Header](#) on page 6 . The orange bar appears below the menu name when selected indicating that this is the menu content that will be displayed.
2. Touch the menu icon, . The menu opens.

## 1.7 User Menu

The user menu lets you view system and unit statuses and edit some setpoints.

### User Menu Options

#### Setpoints

Opens the SETPOINTS panel. See [Viewing and Editing Setpoints for the Cooling Unit](#) on page 15 .

#### Active Alarms

Opens the ALARMS panel. See [Viewing Unit Alarms](#) on page 17 .

#### Event Log

Opens the EVENT LOG panel. See [Viewing the Event Log](#) on page 20 .

#### Sensor Data

Opens the SENSOR DATA panel. See [Viewing Sensor Data](#) on page 20 .

#### Display Options

Opens the Display Options menu:

- Customize Layout: See [Customizing Main Display Views](#) on page 176 .
- Custom Labels: See [Customizing Parameter and Field Labels](#) on page 178 .
- Date & Time: See [Setting the Date and Time](#) on page 8 .

#### Total Run Hours

Opens the RUN HOURS panel. See [Managing Run Hours for a Component](#) on page 20 .

**About**

Opens the ABOUT panel. See [About Vertiv™ Liebert® iCOM™ Version](#) on page 9.

**Turn Unit On/Off**

Depending on unit's status, open the TURN UNIT ON or TURN UNIT OFF dialog. See [Powering Off the Thermal Management Unit](#) on page 8, or [Powering Off the Thermal Management Unit](#) on page 8.

**1.8 Service Menu**

The service menu lets you view and edit setpoints and perform many other functions.

**1.8.1 Service Menu Options****Setpoints**

Opens the SETPOINTS panel. See [Editing Setpoints for the Cooling Unit](#) on page 23.

**Diagnostic/Service**

Opens the Diagnostic/Service menu:

- Diagnostics: See [Performing Diagnostics](#) on page 165.
- Technical Support: Contact information for the cooling unit and Vertiv™ Liebert® iCOM™ display.

**Alarm/Event Setup**

Opens the ALARMS & EVENTS panel. See [Managing Events: Alarms, Warnings and Messages](#) on page 81

**BMS & Teamwork**

Opens the BMS & Teamwork menu:

- U2U Setup: See [Configuring U2U Network Settings](#) on page 98.
- Teamwork/Standby: See [Teamwork, Standby and Rotation for Cooling Units](#) on page 101
- BMS Setup: See [BMS and Vertiv™ Liebert® IntelliSlot™ Settings](#) on page 117

**Scheduler**

Opens the SCHEDULER panel. See [Scheduling Condenser and Cooling Unit Tasks](#) on page 50.

**Options Setup**

Opens the OPTIONS SETUP panel. See [Setting General Thermal Management Unit Options](#) on page 53.

**Auxiliary Device Setup**

Opens the Auxiliary Device Setup menu:

- Sensors: See [Wired Remote Sensors](#) on page 157.

## Backup & Security

Opens the Backup & Security menu:

- Display Backup and Restore: See [Backing Up and Restoring Control Board Settings](#) on page 163 .
- Control Backup and Restore: See [Backing Up and Restoring Control Board Settings](#) on page 163
- Display Upgrade: See [Updating Vertiv™ Liebert® iCOM™ Control Board Firmware](#) on page 161 .
- Control Upgrade: See [Updating Vertiv™ Liebert® iCOM™ Control Board Firmware](#) on page 161 .
- Manage Permissions: See [Managing Access Permission and Passwords](#) on page 164 .

## Turn Unit On/Off

Depending on unit's status, open the TURN UNIT ON or TURN UNIT OFF dialog. See [Powering On the Thermal Management Unit](#) on page 7 , or [Powering Off the Thermal Management Unit](#) on page 8 .

# 1.9 Advanced Menu

The advanced menu provides a read-only view of the advanced set up and factory level settings.

## 1.9.1 Advanced Menu Options

### Factory Settings

Unit code and configuration settings.

### Diagnostics

Details about control and cooling operation.

### Expert Settings

Parameters and settings for use by trained professionals only.

### Compressor Info

Details about compressor state and operating mode.

### Tandem Info

Details about tandem compressor states and operating modes.

### MBV Settings

Motorized ball valve settings (water cooled heat rejection).

### Runtime Monitoring

Details about component run times.

### Modbus Devices

Information about connected Modbus devices such as power and flow meters.



## **Control Override**

Allows simulating events and override of analog outputs beyond normal limits.

## **EEV Settings**

Electronic expansion valve settings.

## **EconoPhase**

Details about Vertiv™ Liebert® EconoPhase pumping unit.

## **MC Condenser**

Details about Vertiv™ Liebert® MC condenser (air cooled heat rejection).

## **Parameter Directory**

A searchable list of all parameters in the user interface. See [Setpoints and Alarm Settings by Line ID](#) on page 205 .

This page intentionally left blank



## 2 User Operation

### 2.1 Viewing and Editing Setpoints for the Cooling Unit

**NOTE:** User level access allows viewing and editing only a limited number of setpoints. To view or adjust all setpoints, you must have service level access. See [Editing Setpoints for the Cooling Unit](#) on page 23 .

**NOTE:** Depending on the type of thermal management unit, included components, and control settings of your system, all of the options listed may not be available on your Vertiv™ Liebert® iCOM™ display.

#### 2.1.1 Editing Humidity Setpoints

1. Touch , then  >Setpoints. > Humidity Control. The HUMIDITY CONTROL secondary panel opens.
2. Refer to [User Humidity Setpoint Options](#) below and [Humidity Control](#) on page 42 to adjust the setpoint options, then touch Save. The setpoint is updated.
  - Touch *Cancel* to discard the changes.

**NOTE:** Depending on the type of thermal management unit, included components, and control settings of your system, all of the options listed may not be available on your Vertiv™ Liebert® iCOM™ display.

#### User Humidity Setpoint Options

##### Dew Point Setpoint

Desired dew point (based on actual return air temperature and humidity) by adding moisture to or removing moisture from the air.

##### Humidity Control Sensor

Selects sensor used when calculating relative humidity.

##### Humidity Control Type

Control when staging humidification operations. Valid values:

- Relative: Percent of humidification/dehumidification is determined by the difference between the humidity-sensor reading and the humidity setpoint.
- Compensated: Percent of humidification/dehumidification is determined by considering the actual deviation from the temperature setpoint and adjusts the humidity setpoint accordingly. The recalculated humidity setpoint displays on the screen.
- Predictive: Percent of humidification/dehumidification is determined by considering the actual deviation from the temperature setpoint and adjusts the humidity sensor reading accordingly. The adjusted humidity sensor reading displays on the screen.
- Dew point: Percent of humidification/dehumidification is determined by the difference between the dew point calculated from the humidity sensor reading and the dew point setpoint.



## Humidity Setpoint

Desired humidity level by adding moisture to or removing moisture from the air.

## Humidity Setpoint 2

Alternate setpoint activated by customer input (remote alarm device). When customer input connection is 2nd Setpoint, this value becomes the active humidity setpoint.

## 2.1.2 Editing Temperature Setpoints

1. Touch , then  > *Setpoints* > *Temperature Control*. The TEMPERATURE CONTROL secondary panel opens.
2. Refer to [User Temperature Setpoint Options](#) below, [Temperature Control—Temperature Setpoints and Cooling Operation](#) on page 27, and [Compressor Control by Cooling Requirement](#) on page 29 to adjust the setpoint options, then touch *Save*.  
The setpoint is updated.
  - Touch *Cancel* to discard the changes.

**NOTE:** Depending on the type of thermal management unit, included components, and control settings of your system, all of the options listed may not be available on your Vertiv™ Liebert® iCOM™ display.

## User Temperature Setpoint Options

### 2nd Temperature Setpoint

Alternate setpoint activated by customer input (remote alarm device). When customer input connection is 2nd Setpoint, this value becomes the active temperature setpoint.

### BMS Backup Temp Setpoint

Selects a temperature setpoint that activates in the event of a BMS timeout. The BMS timer must be configured for this setpoint to activate. See [Setting BMS Backup Setpoints](#) on page 119.

### Optimized Aisle Enabled

Read-only. Indicates that Liebert® iCOM™ is configured for optimized-aisle operation. See [Teamwork Mode 3—Optimized Aisle Operation](#) on page 105.

### Temperature Control Sensor

Selects sensor that controls cooling. Values are:

- Supply Sensor: Temperature control is based on maintaining the temperature of the discharge air from the cooling unit. See [Supply Sensors](#) on page 160.
- Remote Sensor: Temperature control is based on the temperature reading(s) from wired remote sensor(s). See [Wired Remote Sensors](#) on page 157.
- Return Sensor: Temperature control is based on maintaining the temperature of the air returning to the cooling unit.

### Temperature Setpoint Act

Read-only display of adjusted temperature setpoint when one of the following is active:

- Temperature compensation
- BMS backup temperature setpoint
- Customer input setpoint (remote alarm device)

### Temperature Setpoint

Temperature that the unit maintains via cooling/reheat.

## 2.2 Viewing Unit Alarms

The ALARMS panel lists active alarm and warning events. **Table 2.1** below describes the type and state of the alarm shown by indicator dots.

**Table 2.1 Alarm Status and Type Indicators**

Indicator	Description
Yellow dot	Warning event.
Red dot	Alarm event.
Circle	Event condition has cleared, but still must be acknowledged. See <a href="#">Acknowledging Alarms</a> on the next page.

### 2.2.1 To View Alarms

1. Touch , then  > *Alarms*. The ALARMS panel opens.
2. Touch an alarm to display the ALARM DETAILS panel.

### Alarm Fields

#### Alarm

Name of the event.

#### Date

Date event was logged.

#### Time

Time event was logged

## 2.2.2 Alarm Detail Fields

### Alarm

Name of the event.

### Alarm Type

Number representing the event type.

- 1: Warning
- 2: Alarm

### Date/Time

Date and time the event was logged.

### Duration

Time elapsed since event was logged.

### Threshold

Sensor reading at which an event is triggered.

### Unit

Cooling unit to which the alarm applies.

### Value

The current value to which the threshold is compared.

## 2.2.3 Silencing an Audible Alarm

Touch the screen to silence an audible alarm. If the alarm is non-latching, the alarm silences when the condition clears.

**NOTE:** The audible alarm must be enabled in display options to sound. See [Enabling the Audible Alarm Notification](#) on page 92 .

## 2.2.4 Acknowledging Alarms

Depending on the notification settings, alarms and warnings must be acknowledged or reset. An event is active as long as it is unacknowledged, with the exception of the network failure events described in [Table 2.2](#) on the facing page . Once acknowledged, an event remains active until the situation that triggered the event is resolved, see [Table 2.1](#) on the previous page , for event status indicators. When an event acknowledged and cleared, it is removed from the Alarms panel and the LED stops flashing red.

**NOTE:** Acknowledging alarm events does not clear them. To clear an issue, it must be corrected, reset automatically by the controller, or reset manually.

## To Acknowledge Alarms

1. On the ALARMS panel, touch *Acknowledge All*. A check mark overlays the status indicator of the active alarms and warnings, and these automatically clear when the condition is no longer present.
  - If a critical event must be manually reset, the acknowledged items are listed with a Reset All button on the ALARMS panel.
2. Touch *Reset All* to manually reset the condition.

**Table 2.2 Events That Clear without Acknowledgment**

Network Failure	Description
UNIT XX DISCONNECTED	The Liebert® iCOM™ I/O board assigned as U2U address number XX (two up to thirty-two) has lost communication with the group. Make sure all units are powered on at the disconnect. Check cable connections and network settings where applicable.
NO CONNECTION W/UNIT 1	The Liebert® iCOM™ I/O board assigned as U2U address number 1 has lost communication with the group. Make sure all units are powered on at the disconnect. Check cable connections and network settings where applicable.
BMS DISCONNECT	The BMS/BAS has not completed a handshake within the time defined by the BMS/BAS. Verify monitoring connections and communication to the BMS/BAS panel.
UNIT CODE MISSING	The factory unit code must be confirmed, saved and executed.
UNIT CODE MISMATCH	The factory unit code must be confirmed, saved and executed.
AMBIENT SENSOR FAILURE	The outdoor temperature / humidity sensor used on the air economizer unit has become disconnected or is no longer working properly.
CAN GC 1 or 2 COMM ERR	See <b>Table 4.3</b> on page 88 .
CAN PB COMM ERR	See <b>Table 4.4</b> on page 90 .
CAN EEV 1 or 2 COMM ERR	See <b>Table 4.6</b> on page 91
COMP 1 or 2 OVERLOAD	See <b>Table 4.5</b> on page 91 .
LOW PRESS CIRCUIT 1 or 2	See <b>Table 4.5</b> on page 91 .

## 2.3 Viewing the Event Log

The event log is a list by date/time of the last 400 events generated by Vertiv™ Liebert® iCOM™ for the thermal management unit.

- On the User menu, touch *Event Log*. The EVENT LOG for the cooling unit opens. **Table 2.3** below describes the color coded status for each event.



**NOTE: Depending on the type of thermal management unit, included components, and control settings of your system, all of the options listed may not be available on your Vertiv™ Liebert® iCOM™ display.**

**Table 2.3 Event Status/Type Indicators**

Indicator	Description
Green dot	Message.
Yellow dot	Unacknowledged warning event. See <a href="#">Acknowledging Alarms</a> on page 18 .
Red dot	Unacknowledged alarm event. See <a href="#">Acknowledging Alarms</a> on page 18 .
White dot with check-mark overlay	Acknowledged event, the cause still exists.
White circle	Acknowledged event, the cause is cleared.

## 2.4 Viewing Sensor Data

The Sensor Data panel lists the standard and optional sensors monitored by Vertiv™ Liebert® iCOM™ and the current reading of each sensor.



- Touch  , then  > *Sensor Data*. The SENSOR DATA panel opens.

A secondary panel displays the DAILY SENSOR READING SUMMARY, which shows temperature, humidity and dew-point readings for the cooling unit.

**NOTE: Depending on the type of thermal management unit, included components, and control settings of your system, the options on your Liebert® iCOM™ display may differ.**

## 2.5 Managing Run Hours for a Component

You can view the run hours for components on a cooling unit, set the total run time limit and reset total run hours to zero.

- Touch  , then  > *Total Run Hours*. The RUN HOURS panel opens and the current hours for each component are listed in the Total Run Hours column.  
To reset the total run hours to zero, see [Setting Run Hours to Zero](#) below .
- Use the slider to set the total run time limit for each component, then touch *Save*. The limits are set.

### 2.5.1 Setting Run Hours to Zero

- On the RUN HOURS panel, touch to check each box in the *Total Run Hours* column next to the component(s) to reset. The Set to Zero button becomes available.
- Touch *Set to Zero*. The total run hours for the selected component(s) is set to zero.



## 2.6 Viewing Vertiv™ Liebert® EconoPhase Operation

When your Thermal Management System is a Vertiv™ Liebert® DSE system with a Liebert® EconoPhase pumped refrigerant economizer (PRE) and a Vertiv™ Liebert® MC or MCV condenser, the Liebert® EconoPhase screen, **Figure 2.1** below, shows the operating mode of the system. The Liebert® DSE System Optimization feature is automatically employed and reduces power consumption significantly because a PRE package consumes about one-tenth the power of the compressors.

Liebert® EconoPhase operation saves energy by eliminating compressor operation when outdoor ambient temperatures are cool enough, or when the difference between the indoor and outdoor ambient temperature is satisfied. Liebert® DSE System Optimization further improves efficiency by optimizing liquid refrigerant temperature and pressure setpoints in mid- and high-ambient temperature conditions, thus reducing the operation of condenser fans while maintaining the appropriate heat rejection capacity.

**Figure 2.1** Vertiv™ Liebert® EconoPhase Pump Mode Screen

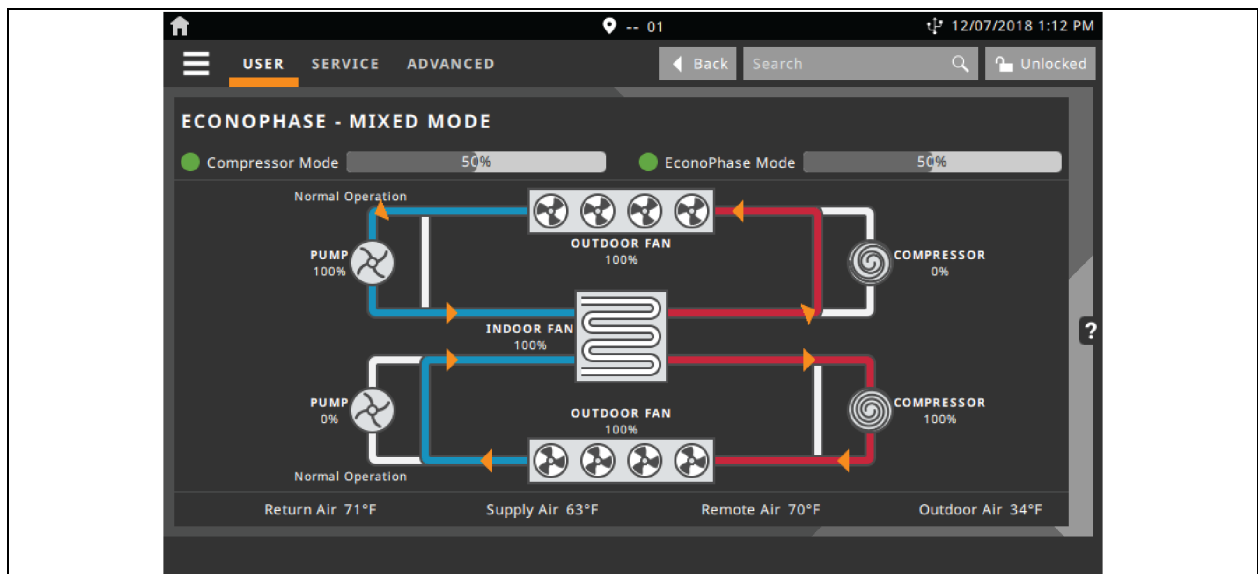

## 2.7 Viewing Teamwork, Standby, and Cascade Status

In the main User panel, the Teamwork Mode icon indicates the mode selected, **Figure 2.2** below.

### 2.7.1 To View the Teamwork Details

Touch the Teamwork mode icon.

The teamwork dialog opens displaying the teamwork mode, number of units in standby, and number of operating units.

**NOTE:** You must be logged in with the Service PIN to edit teamwork mode. See [Powering On the Vertiv™ Liebert® iCOM™ and Logging In/Unlocking Controls](#) on page 6.

**Figure 2.2** Teamwork Icons

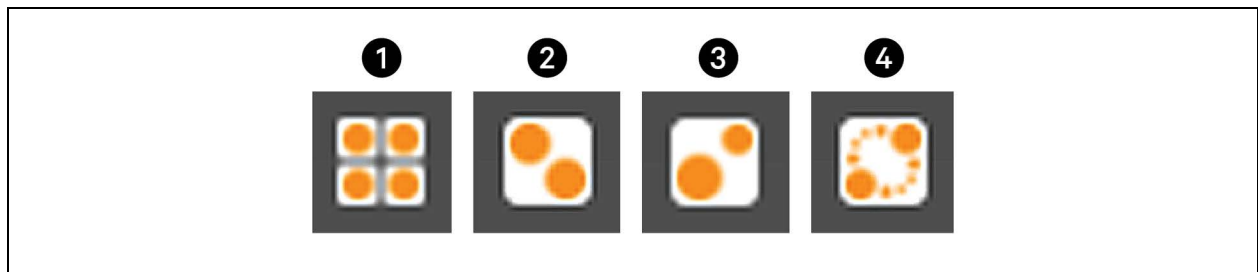

Item	Description
1	No teamwork.
2	Mode 1 - Parallel teamwork
3	Mode 2 - Independent teamwork
4	Mode 3 - Optimized aisle teamwork

## 3 Service Operation

### 3.1 Editing Setpoints for the Cooling Unit

Setpoints are the means by which cooling unit operation is controlled.

**NOTE:** Depending on the type of thermal management unit, included components, and control settings of your system, all of the options listed may not be available on your Vertiv™ Liebert® iCOM™ display.

#### 3.1.1 Setpoints Options

##### Fan Control

See [Configuring Fan Setpoints](#) on page 43.

##### High/Low Limit Control

See [Configuring High/Low Limit Setpoints](#) on page 39.

##### Humidity Control

See [Configuring Humidity Setpoints](#) on page 40.

##### Static Pressure Settings

See [Configuring Static Pressure Setpoints](#) on page 47.

##### Temperature Control

See [Configuring Temperature Setpoints](#) on the next page.

##### Temperature Compensation

See [Setting Temperature Compensation](#) on page 37.

## 3.1.2 Configuring Temperature Setpoints

1. Touch , then  > *Setpoints* > *Temperature Control*. The TEMPERATURE CONTROL secondary panel opens.
2. Refer to [Temperature Control Options](#) below, [Temperature Control—Temperature Setpoints and Cooling Operation](#) on page 27, and [Compressor Control by Cooling Requirement](#) on page 29 to adjust the setpoint options, then touch Save.  
The setpoint is updated.

**NOTE: Proportional band setting is dependent on the heat load and the components specific to your cooling unit. Additional tuning may be required after start up when using PI temperature control. See [Considerations when Using PI Temperature Control](#) on page 28.**

**NOTE: Depending on the type of thermal management unit, included components, and control settings of your system, all of the options listed may not be available on your Vertiv™ Liebert® iCOM™ display.**

### Temperature Control Options

#### AutoSet Enabled

When enabled, the proportional band for temperature and humidity and both integration time factors are set automatically based on the type of cooling unit (single compressor, dual compressor or chilled water).

**NOTE: General settings cannot be adjusted or changed when AutoSet is enabled. If you make a change when AutoSet is enabled, the parameter defaults back to its original setting.**

#### BMS Backup Temp Setpoint

Temperature that the cooling unit maintains during BMS backup operation.

#### Dehumidification Reheat Proportional Band

Sets reheat operation independently from the temperature proportional band. Adjusts the activation point of dehumidification components based on deviation of the selected dehumidification reheat temp control sensor and the dehumidification reheat setpoint by placing half of the selected value on each side of the setpoint. A smaller number causes faster reaction to temperature changes.

#### Dehumidification Reheat Setpoint

Temperature that the unit maintains via dehumidification reheat.

#### Dehumidification Reheat Temp Control Sensor

Selects the sensor that controls dehumidification reheat. Values are:

- SUP: Temperature control is based on maintaining the temperature of the discharge air from the cooling unit. See [Supply Sensors](#) on page 160.
- REM: Temperature control is based on the temperature reading(s) from wired remote/rack sensor(s). See [Wired Remote Sensors](#) on page 157.
- RET: Temperature control is based on maintaining the temperature of the room air.

## Heater Deadband

Widens the setpoint to prevent small temperature changes from cycling re-heat components.

## Temperature Control Sensor

Selects sensor that controls cooling. Values are:

- Supply Sensor: Temperature control is based on maintaining the temperature of the discharge air from the cooling unit. See [Supply Sensors](#) on page 160 .
- Remote Sensor: Temperature control is based on the temperature reading(s) from wired remote/rack sensor(s). See [Wired Remote Sensors](#) on page 157 .
- Return Sensor: Temperature control is based on maintaining the temperature of the room air.
- Customer input setpoint (remote alarm device)

With regards to Temperature Control and Fanspeed Control, Liebert® iCOM™ controller shall support the following sensor configurations:

- Mode A: Cooling = Supply Sensor, Fanspeed = Supply Sensor
- Mode B: Cooling = Remote Sensor, Fanspeed = Remote Sensor
- Mode C: Cooling = Return Sensor, Fanspeed = Return Sensor
- Mode D: Cooling = Supply Sensor, Fanspeed = Remote Sensor
- Mode E: Cooling = Supply Sensor, Fanspeed = Return Sensor

**NOTE: Sensor configurations A-E are supported in Teamwork Mode 2 - Independent and Teamwork Mode 3 - Optimized Aisle.**

**NOTE: Sensor configurations B & C are supported in Teamwork Mode 1 - Parallel.**

**NOTE: Prior to enabling any version of Teamwork Mode, the controlling sensors for Temperature Control (cooling capacity) and Fanspeed Control must first be defined within Liebert® iCOM™.**

## Temperature Control Type

Control when staging cooling and heating operations. Values are:

- Proportional: Percent of cooling/heating determined by the difference between the air temperature sensor reading and the temperature setpoint.
- P: Percent of cooling/heating calculated using the temperature proportional band and temperature-integration time settings. See [Considerations when Using PI Temperature Control](#) on page 28 .
- Adaptive PID: Auto-tuning PID control loop, can be set for cooling. Only available on Liebert® chilled water systems.
- Intelligent: Percent of cooling/heating determined by programmed logic that simulates manual human control.

## Temperature Deadband

Widens the setpoint to prevent small temperature changes from cycling compressors and valves maximizing component life. When temperature is within the deadband, no change of the control output (heating/cooling) occurs.

### **Temperature Integration Time**

Adjusts amount of cooling/heating based on the length of time the temperature has deviated from the setpoint. The time selected is the amount of time it will take cooling capacity to reach 100%. For example, if three minutes is selected, cooling capacity will increase to 100% in three minutes.

**NOTE: Three to five minutes of integration time is adequate for most applications. See Considerations when Using PI Temperature Control on page 28 .**

**NOTE: Only used when Temperature Control Type is PI.**

### **Temperature Proportional Band**

Adjusts the activation point of cooling/heating components based on deviation from setpoint by placing half of the selected value on each side of the temperature control setpoint. A smaller number causes faster reaction to temperature changes.

**NOTE: Setting this too low causes short cycling of compressors.**

### **Temperature Setpoint**

Temperature that the unit maintains via cooling/reheat.

### **Temperature Setpoint Act**

Read-only display of adjusted temperature setpoint when one of the following is active:

- Temperature compensation.
- BMS backup temperature setpoint.

### 3.1.3 Temperature Control—Temperature Setpoints and Cooling Operation

Temperature control refers to the cooling unit’s response to programmed setpoints and sensed room/load conditions. Temperature control is closely-tied to the primary cooling source. Liebert® Thermal management units employ several types of primary cooling sources:

#### Compressor Operation

Vertiv™ Liebert® iCOM™ controls the cooling units based on a calculated need for cooling (and heating, if included on your system). The requirement is expressed as a percentage and is calculated using the selected temperature control type.

#### Temperature Proportional Band

Use the proportional and deadband parameters to control how your cooling unit(s) respond based on the calculated need for cooling (or heating). **Figure 3.1** below, illustrates temperature control using:

- 70° setpoint
- 10° proportional band
- No deadband

The proportional band is divided evenly on each side of the setpoint:

- 0% cooling capacity is required at 70°.
- As the air temperature increases, cooling also increases along the proportional band.
- If the air temperature reaches 75°, the system operates at 100% cooling capacity.
- If air temperature rises to the end of the proportional band or further, the system operates at 100% capacity to bring the temperature down to the setpoint.
- If your unit includes reheat, the heating capacity operates in the same way as the air temperature falls below the setpoint. See [Reheat Control](#) on page 61.

**Figure 3.1** Temperature Control without a Deadband

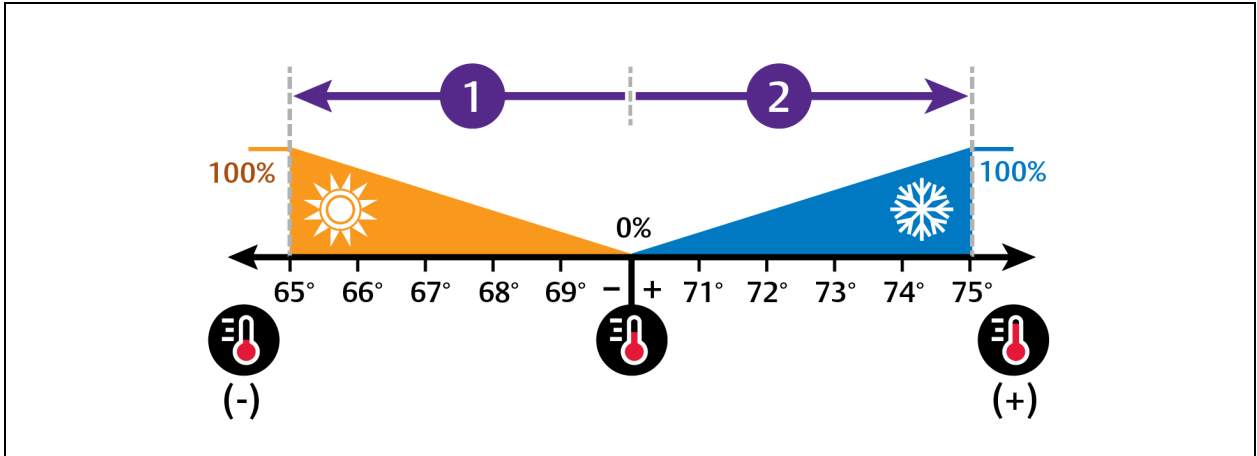

No.	Description
1	½ of proportional band.
2	½ of proportional band.

### Temperature Deadband

A deadband widens the setpoint to prevent small temperature changes from activating compressors and valves and cause excessive component cycling. **Figure 3.2** below, illustrates temperature control using:

- 70° setpoint
- 10° proportional band
- 2° deadband

Like the proportional band, the deadband is also divided evenly on each side of the setpoint:

- 0% cooling capacity is required from 69° to 71°.
- At 71°, the system operates according to the temperature proportional band.

**Figure 3.2 Temperature Control with a Deadband**

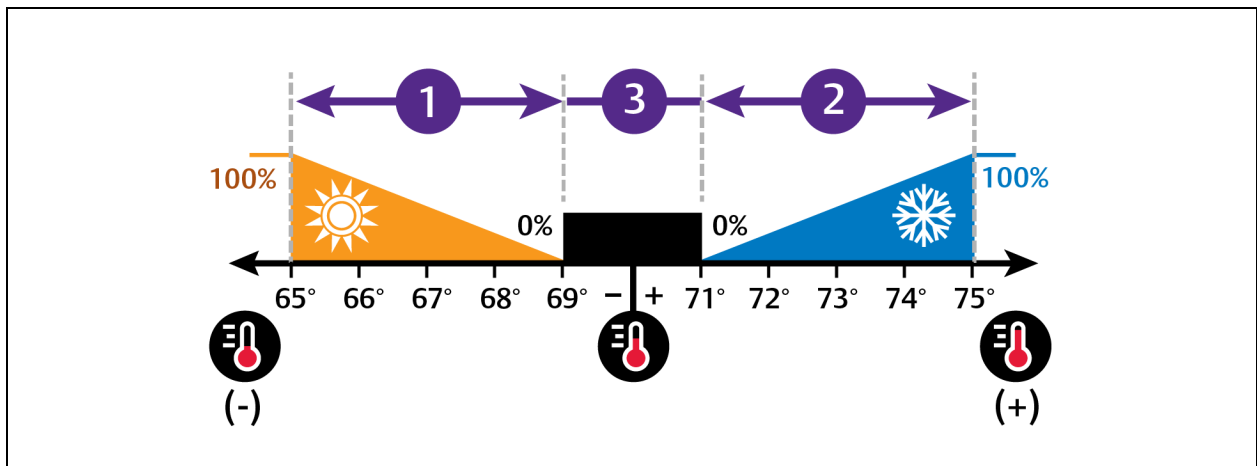

No.	Description
1	½ of proportional band.
2	½ of proportional band.
3	Deadband.

### Considerations when Using PI Temperature Control

Several factors, such as room heat load, external heat gains, and component-specific performance can affect the PI control loop. Adjusting the temperature proportional band and integration time can improve cooling unit performance and avoid problems detailed in **Table 3.1** on the facing page.



**Table 3.1 PI Temperature Control Troubleshooting**

Problem	Solution
Cooling is slow to activate	Decrease the proportional band slightly and monitor operation. Repeat until cooling reaction time is acceptable.
Compressor short cycle alarm	Increase the proportional band slightly by increasing the integration time between 3 and 5 minutes, and monitor compressor run time. Set the temperature deadband to 2. Run time must be more than three minutes to prevent a short cycle of the compressor.
Excessive valve oscillation or hunting	Increase the proportional band and/or increase integration time.

### 3.1.4 Compressor Control by Cooling Requirement

Compressor control is directly linked to temperature control in that the cooling requirement determined by the temperature proportional band determines compressor operation. Depending on the type of cooling unit, the number and type of compressors varies. The following describes compressor operation along the proportional band for the varying compressor options.

#### One Scroll Compressor without Unloaders

- 70° setpoint
- 8° proportional band
- 2° deadband

In **Figure 3.3** on the next page :

The compressor starts at 75° when the cooling requirement is 100% and continues to operate until 71° is reached when cooling requirement is 0%.

**Figure 3.3 Compressor Control—One Step Capacity**

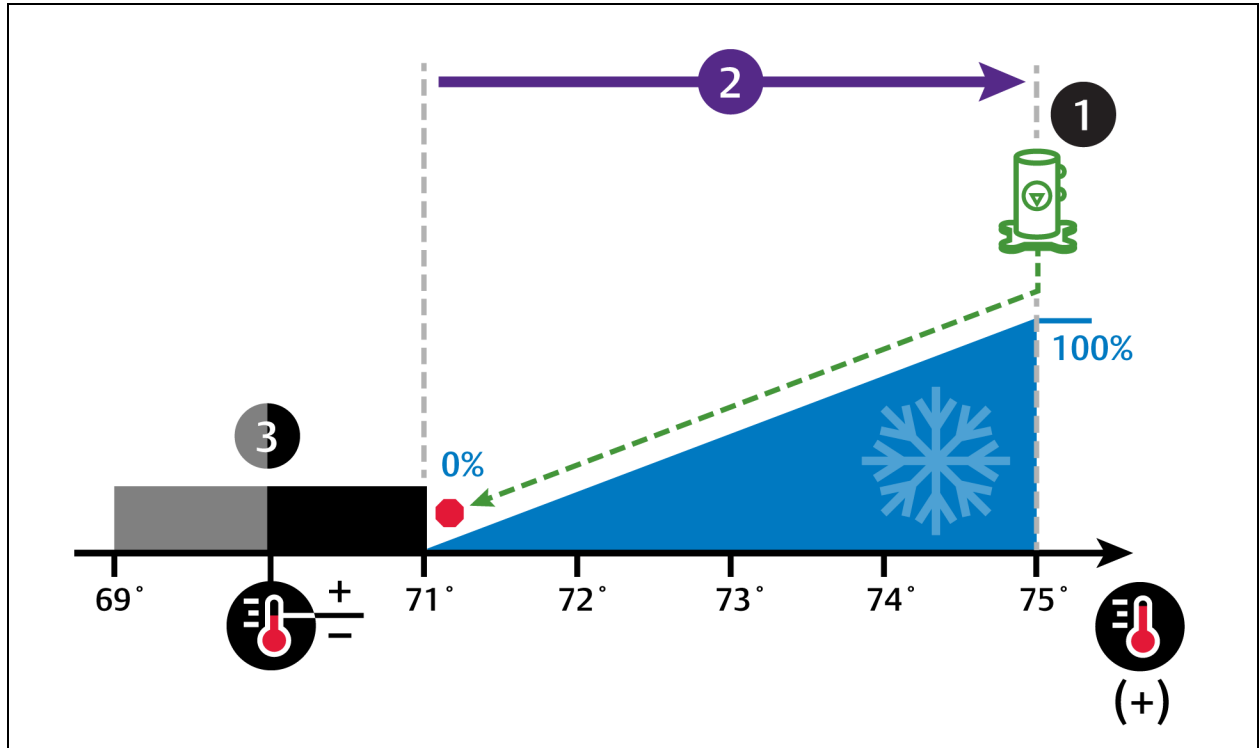

No.	Description
1	Single scroll compressor.
2	½ of proportional band.
3	Deadband.

**Two Scroll Compressors without Unloaders**

- 70° setpoint
- 8° proportional band
- 2° deadband

In **Figure 3.4** on the facing page :

Compressor 1 starts at 73° when the cooling requirement is 50% and continues to operate until 71° is reached when cooling requirement is 0%.

Compressor 2 starts at 75° when the cooling requirement is 100% and continues to operate until 73° is reached when cooling requirement is 50%.

Figure 3.4 Compressor Control—Two Step Capacity Using Two Scroll Compressors without Unloaders

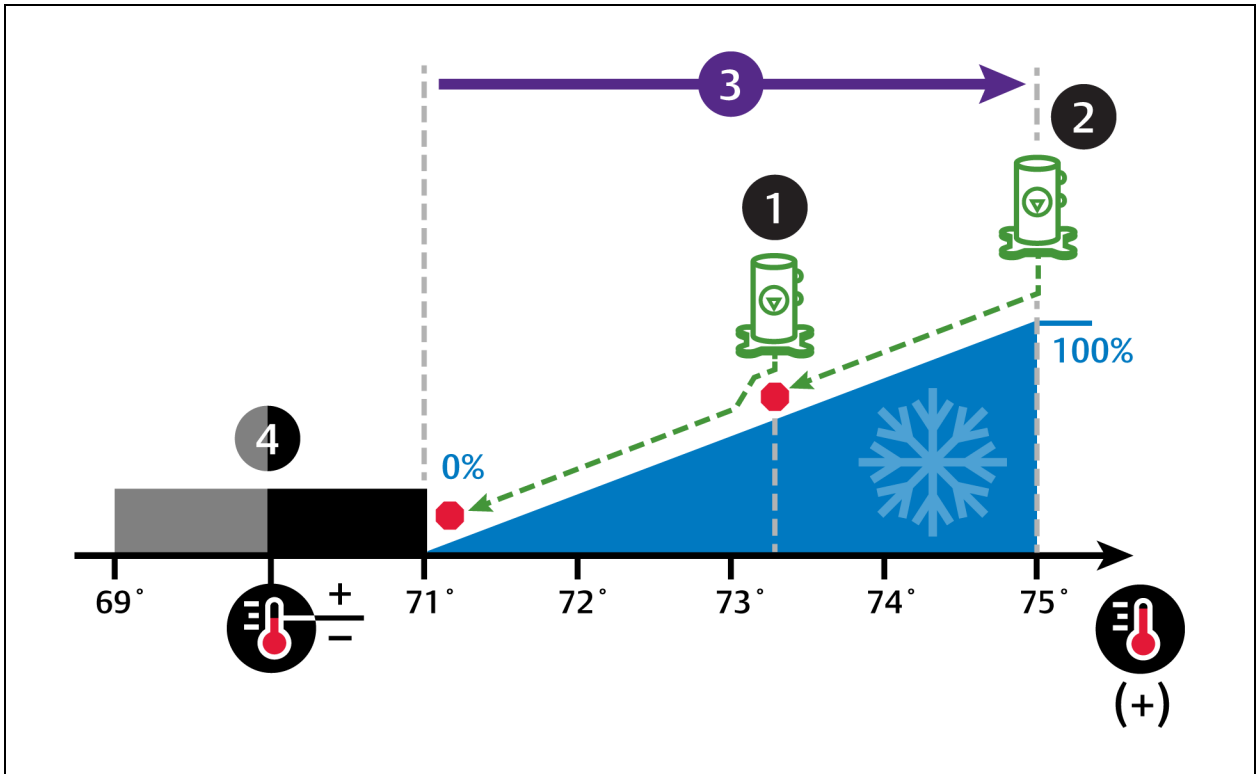

Number	Description
1	Scroll compressor 1.
2	Scroll compressor 2.
3	½ of proportional band.
4	Deadband.

**One Scroll Compressor with Unloader**

- 70° setpoint
- 8° proportional band
- 2° deadband

In **Figure 3.5** on the next page :

The compressor starts unloaded at 73° when the cooling requirement is 50%.

At 75° when the cooling requirement is 100%, the compressor operates loaded until 73° is reached when cooling requirement is 50% and it returns to unloaded operation.

**Figure 3.5 Compressor Control—Two Step Capacity Using One Scroll Compressor with Unloaders**

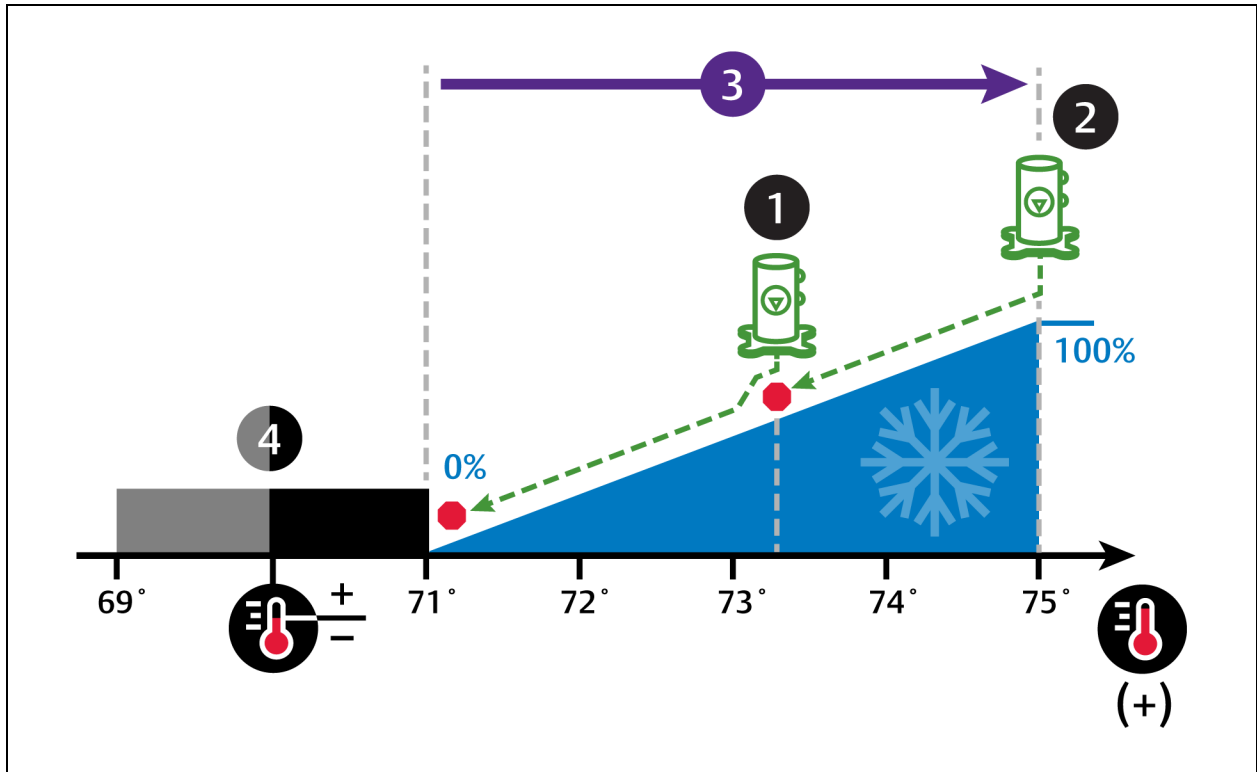

Number	Description
1	Scroll compressor unloaded.
2	Scroll compressor loaded.
3	½ of proportional band.
4	Deadband.

**Two Scroll Compressors with Unloaders**

- 70° setpoint
- 8° proportional band
- 2° deadband

In **Figure 3.6** on the facing page :

Compressor 1 starts unloaded when the cooling requirement is 33% and continues to operate until the cooling requirement is 17% or, if the cooling requirement reaches 80%, Compressor 1 operates loaded until the requirement is 70%.

Compressor 2 starts unloaded when the cooling requirement is 63% and continues to operate until the cooling requirement is 47% or, if the cooling requirement reaches 100%, Compressor 2 operates loaded until the requirement is 90%.

Figure 3.6 Compressor Control—Four Step Capacity

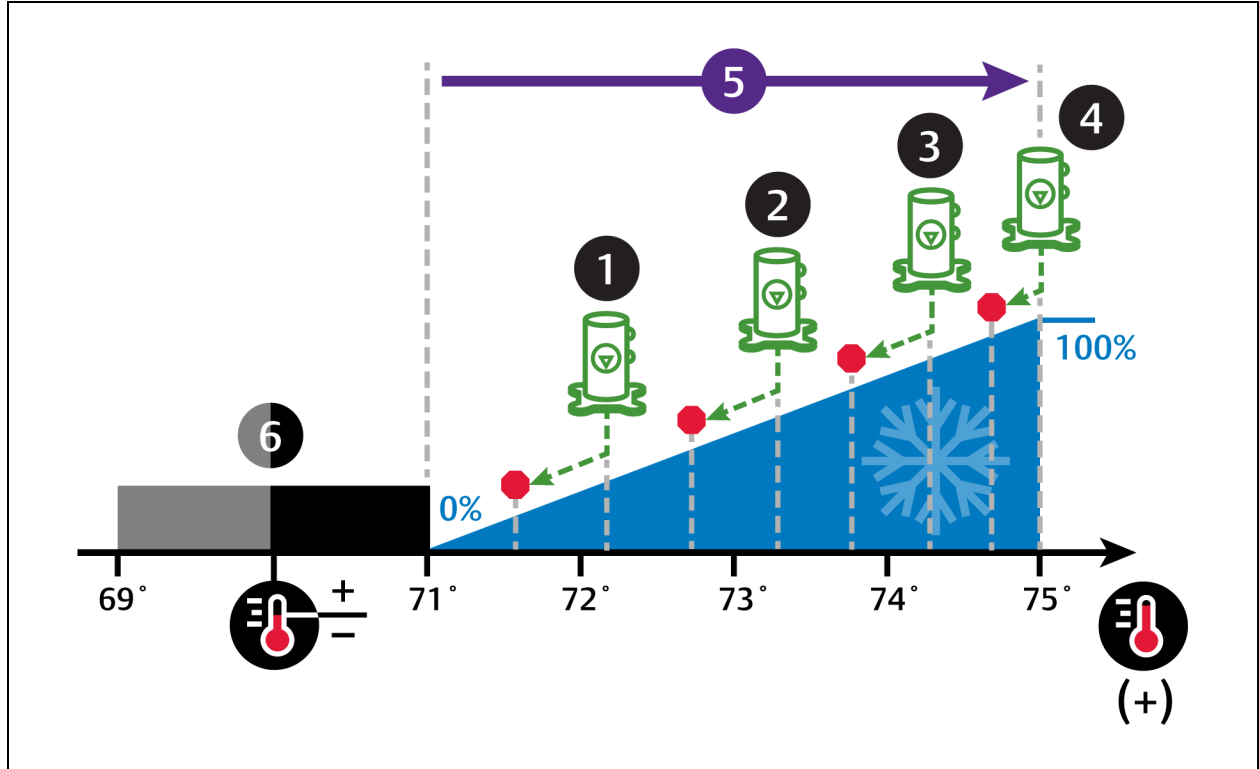

No.	Description	No.	Description
1	Step 1: Compressor 1 starts unloaded.	4	Step 4: Compressors 1 and 2 operate loaded.
2	Step 2: Compressor 2 starts unloaded.	5	½ of proportional band.
3	Step 3: Compressor 1 operates loaded and compressor 2 operates unloaded.	6	Deadband.

### Digital Scroll Compressors

Digital scroll compressors use time loaded/unloaded to modulate cooling capacity between 10% and 100% to control cooling more precisely than non-digital compressors. Capacity modulation is achieved by opening and closing a digital solenoid valve in 15 second intervals while the compressor runs continuously when the cooling requirement is 10% to 100%.

- When the valve is opened (energized, the compressor is unloaded and capacity is 0% (because the scroll plates are separated so that there is no refrigerant flowing through the compressor).
- When the valve is closed (de-energized), the compressor is loaded and capacity is 100%.
- Capacity is determined by the amount of time that the valve is closed in the 15 second interval. **Figure 3.7** on the next page illustrates solenoid-valve operation when cooling requirement is 66%.
  - The valve is closed for 10 seconds (100% cooling).
  - The valve is then open for 5 seconds (0% cooling).
  - This results in 66% cooling. Essentially, the compressor is partially loaded.

**Figure 3.7 Digital Scroll Compressor Operation to Provide 66% Cooling Capacity**

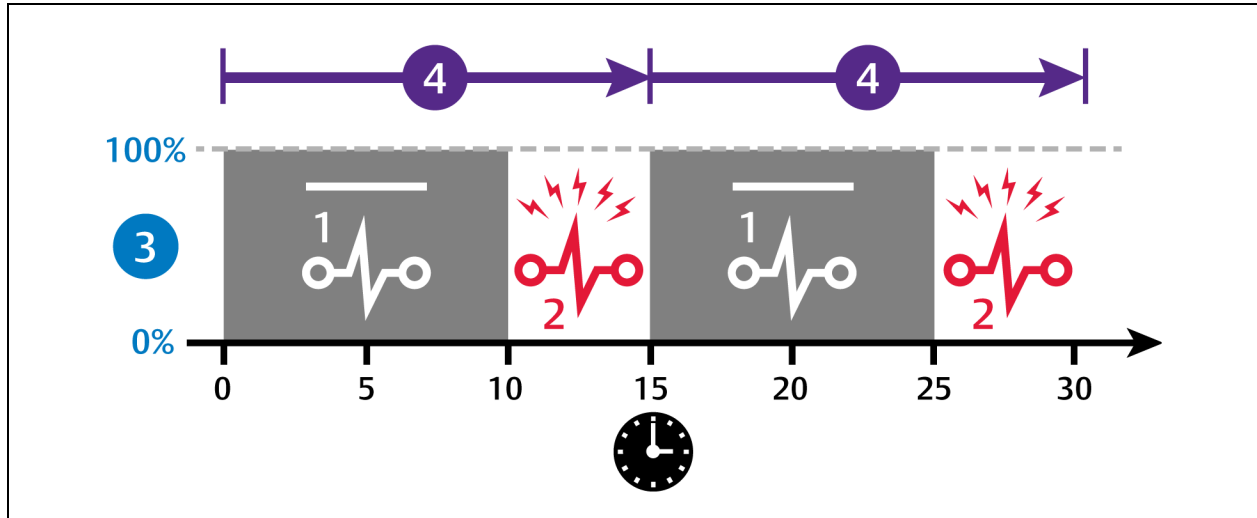

No.	Description
1	Solenoid de-energized.
2	Solenoid energized.
3	Percent loaded.
4	15 second capacity modulation cycle.

### One Digital Scroll Compressor

In a single digital scroll system:

- The compressor starts when the cooling demand is at least 25% (calculated from temperature proportional band) and operates at 50% capacity (valve open 7.5 seconds/closed 7.5 seconds) for an initial period set in Winter Start Delay (see [Setting Low Pressure Time Delay](#) on page 59 ), after which it operates per cooling demand.
- As cooling demand increases, the length of time the valve is closed increases/capacity increases.
- At 100% cooling requirement, the valve remains closed for the entire 15 second interval and the compressor is operating loaded at 100% capacity.
- The compressor stops when cooling demand decreases to 10%.

**Figure 3.8** on the facing page illustrates digital scroll compressor operation with the following setpoint parameters:

- 70° setpoint
- 8° proportional band
- 2° deadband

Figure 3.8 Compressor Control—Single Digital Scroll Compressor

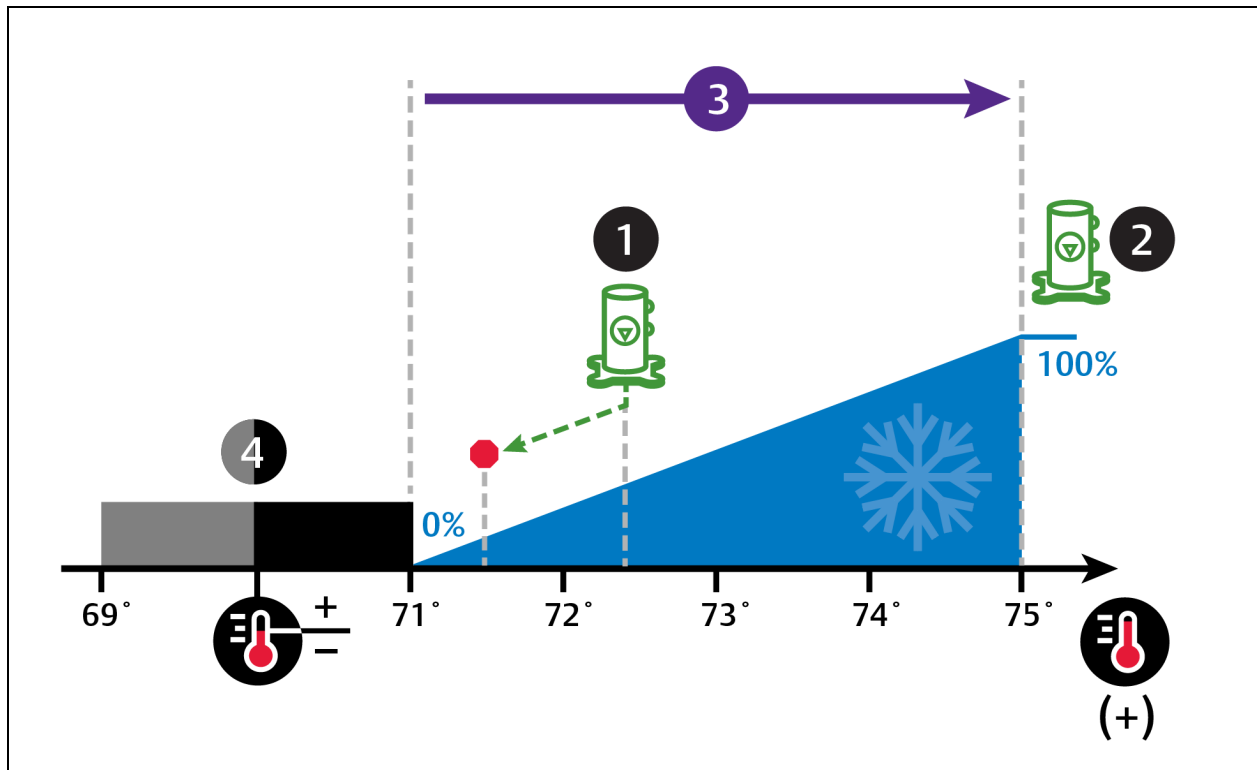

No.	Description
1	Digital scroll begins operation
2	Digital scroll operation at 100%
3	½ of proportional band
4	Deadband

### Dual Digital Scroll Compressors

In a two digital scroll system, the compressors operate in a lead-lag configuration:

- The lead compressor starts when the cooling demand is at least 25% (calculated from temperature proportional band) and operates at 50% capacity (valve open 7.5 seconds/closed 7.5 seconds) for an initial period set in Winter Start Delay (see [Setting Low Pressure Time Delay](#) on page 59), after which it operates per cooling demand.
- The lag compressor starts when cooling demand is 35% and operates at 70% capacity, increasing capacity as cooling demand increases.
- On both compressors at 100% cooling requirement, the valve remains closed for the entire 15 second interval and the compressors operate loaded at 100% capacity.
- The lag compressor stops when the cooling demand decreases to 20%.
- The lead compressor stops when cooling demand decreases to 10%.

Figure 3.9 below illustrates digital scroll compressor operation with the following setpoint parameters:

- 70° setpoint
- 8° proportional band
- 2° deadband

Figure 3.9 Compressor Control—Dual Digital Scroll Compressor

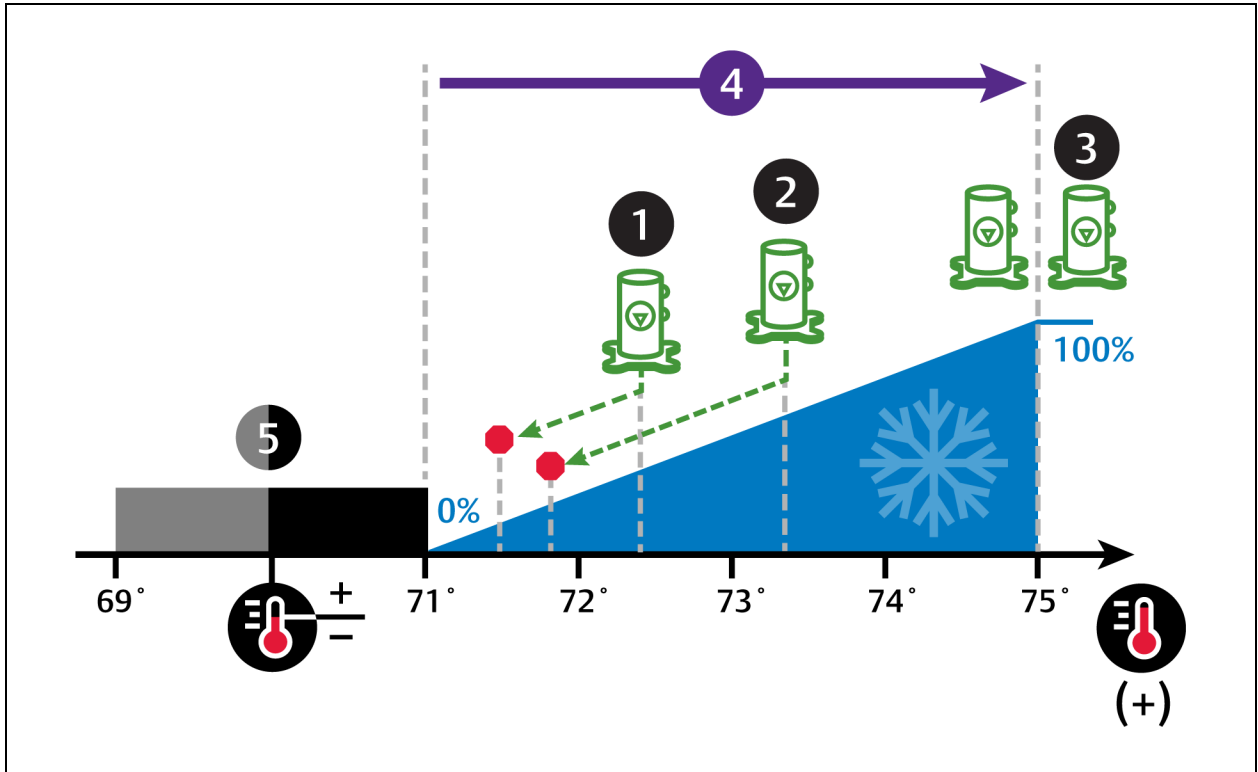



No.	Description
1	Lead compressor
2	Lag compressor
3	Lead and lag compressors.
4	½ of proportional band
5	Deadband



### 3.1.5 Setting Temperature Compensation

Temperature compensation provides protection from changes that affect capacity and heat load by monitoring temperature conditions and fan speed settings, then automatically adjusting the temperature setpoint. Changes that may cause temperature compensation are floor tile removal in non-cold aisle areas, incorrect supply temperature setpoint, unit failure in a neighboring zone, or unexpected heat load fluctuations at rack equipment.

Temperature compensation is also tied in to cascade/standby operation in Teamwork Mode 3. See [Teamwork Mode 3—Optimized Aisle Operation](#) on page 105.

1. Touch , then  > *Setpoints* > *Temperature Compensation*. The TEMPERATURE COMPENSATION secondary panel opens.
2. Select the Compensation Type, then touch *Save*. The setpoint is updated.
  - Return temperature compensation cannot be used when both fan and cooling control is set to Return.
  - Supply temperature compensation requires the following settings:
    - Temperature Control Sensor: Supply Sensor
    - Fan Control Sensor: Remote Sensor

**NOTE:** When temperature compensation is enabled and active, the Temperature Setpoint Act field on the Temperature Control setpoints panel displays the adjusted setpoint value.

**NOTE:** Depending on the type of thermal management unit, included components, and control settings of your system, all of the options listed may not be available on your Vertiv™ Liebert® iCOM™ display.

### Temperature Compensation Options

#### Compensation Type

Selects the compensation routine:

- No: Temperature compensation routine disabled.
- Return: Increases the temperature setpoint when the return air temperature is too cold.
- Supply: Decreases the temperature setpoint when the air flow capacity approaches 100% and the cold aisle temperature remains above the setpoint.
- Supply+Return: Allows both supply and return compensation.

### 3.1.6 Fan Temperature Compensation

For applications where unit fan speed is being controlled off the return sensor, Vertiv™ Liebert® iCOM™ shall also support the capability of simultaneously utilizing remote 2T sensor values to override the return air temperature setpoint associated with fan speed control. Once enabled, when a high remote temperature is detected, the Fan Temperature Compensation routine shall temporarily increase fan speed output to compensate for the high remote temperature by decreasing the return temperature setpoint by a value specified by the end-user.

The remote 2T sensors required for this feature shall monitor cold aisle temperatures while fan speed is driven by the return air sensor and corresponding setpoint. As the remote temperature increases above the Fan Temp Comp – Remote Setpoint, fan speed control setpoint (return air setpoint) shall begin to decrease starting with 0°F/0.0K adjustment when at the remote setpoint and ending with the maximum adjustment as defined by Fan Temp Comp – Adjust Band (i.e. Fan Temp Comp – Rem Temp Setpoint + Fan Temp Comp – Rem Band). In the event the remote temperature sensor reading is considered invalid, Liebert® iCOM™ shall fall back and use Fan Temp Comp – Rem Temp Backup value for control. When the remote temperature is continuously above the sum of Fan Temp Comp – Remote Setpoint + Fan Temp Comp – Rem Band, the Fan Temp Comp Limit alarm event shall annunciate after the defined delay time has surpassed.

- Fan Temp Comp – Operation – enables/disables Fan Temperature Compensation routine
- Fan Temp Comp – Rem Temp Setpoint – remote temperature threshold at which routine activates
- Fan Temp Comp – Rem Band – adjustment band
- Fan Temp Comp – Adjust Value – value subtracted from return temperature setpoint as remote temperatures rise above
- Fan Temp Comp – Rem Temp Backup – remote temperature backup value which shall be used in the event remote sensor values are considered invalid.

**Figure 3.10 Fan Temperature Compensation**

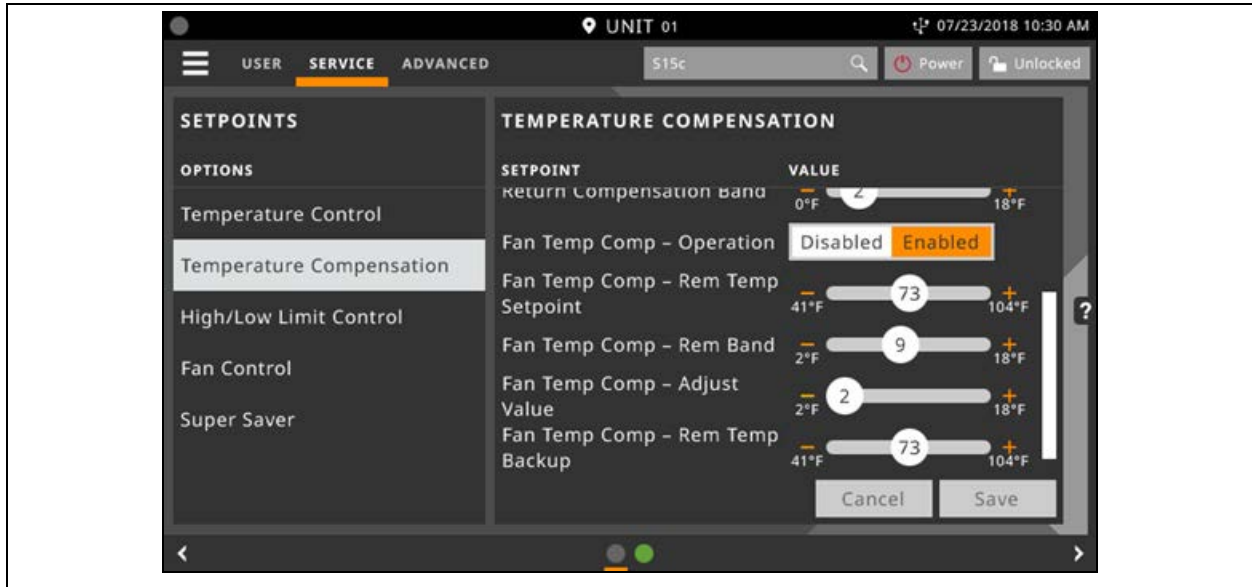



### 3.1.7 Configuring High/Low Limit Setpoints

Setting dehumidification low limits avoids over cooling a room during dehumidification. When a low limit is reached, the cooling source used for dehumidification is disabled. Dehumidification resumes when air temperature rises above the low limit reset value.

**NOTE: Dehumidification lock out can occur with improper low limit settings. To avoid lockout, increase heat load for efficient operation, decrease low limit settings slightly, and where applicable, decrease the reheat proportional band to allow reheat sooner.**

#### To Set High and Low Limits

1. Touch , then  > *Setpoints > High/Low Limit Control*. The HIGH/LOW LIMIT CONTROL secondary panel opens.
2. Adjust the setpoint options, then touch Save. The setpoint is updated.
  - Touch *Cancel* to discard the changes.

**NOTE: Depending on the type of thermal management unit, included components, and control settings of your system, all of the options listed may not be available on your Vertiv™ Liebert® iCOM™ display.**

#### High/Low Limit Control Options

##### Dehum Low Limit X

Temperature at which dehumidification is interrupted, where X is limit 1 or 2.

##### Dehumidification Low Limit Sensor

Selects the sensor that is used for the low limit determination.

##### Dehumidification Low Limit Setpoint

Temperature below which dehumidification is disabled.

##### High Return Limit

Enables/disables use of additional fan speed based on return air temperature.

##### Return Limit P-band

Calculates fan speed based on proportional deviation from the return air temperature.



##### Supply Limit Enabled

Enables/disables use of additional fan speed based on supply air temperature.

##### Supply Temp Limit Setpoint

Supply air temperature at which use of additional fan speed is enabled.

### 3.1.8 Configuring Humidity Setpoints

1. Touch , then  > *Setpoints > Humidity Control*. The HUMIDITY CONTROL secondary panel opens.
2. Refer to [Humidity Control Options](#) below and [Humidity Control](#) on page 42 to adjust the setpoint options, then touch *Save*. The setpoint is updated.
  - Touch *Cancel* to discard the changes.

**NOTE:** Depending on the type of thermal management unit, included components, and control settings of your system, all of the options listed may not be available on your Vertiv™ Liebert® iCOM™ display.

#### Humidity Control Options

##### Control Dew Point

Dew point setpoint.

##### Dew Point Deadband

Widens the setpoint to prevent small changes from cycling compressors and valves maximizing component life. When temperature is within the deadband, no change of the control output (humidification) occurs.

##### Dew Point P-Band

Adjusts the activation point of humidifier/dehumidification components based on deviation from setpoint by placing half of the selected value on each side of the dew point setpoint. A smaller number causes faster reaction to humidity changes.

##### Dew Point Setpoint

Humidity level (based on actual return air temperature and humidity) by adding moisture to or removing moisture from the air.

##### Humidity Control Sensor

Selects sensor used when calculating relative humidity.

## Humidity Control Type

Controls humidification/dehumidification operation. Valid values are:

- Proportional: Percent of humidification/dehumidification determined by the difference between the humidity sensor reading and the humidity setpoint.
- Dew Point: Percent of humidification/dehumidification determined using the measured return temperature and humidity to calculate the dew point and comparing it to the setpoints.

**NOTE: When dew point is selected, the humidity setpoint and proportional band units are degrees dew point.**

- Relative: Percent of humidification/dehumidification determined using the measured humidity content of the air to calculate the percent relative humidity (RH) and comparing it to the setpoints.

**NOTE: Relative humidity control can cause unnecessary humidification/dehumidification from over cooling based on a higher than normal RH reading that causes extended dehumidification, which in turn causes a low RH reading that activates the humidifier.**

- Compensated: Percent of humidification/dehumidification determined using the measured humidity content of the air and automatically adjusting the humidity setpoint.

**NOTE: Compensated humidity control prevents unnecessary humidification/dehumidification noted with relative humidity control.**

- Predictive: Percent of humidification/dehumidification determined using the measured humidity content of the air and automatically adjusting the humidity sensor reading.

## Humidity Deadband

Widens the setpoint to prevent small changes in humidity from cycling components and also maximizes component life. When humidity is within the deadband, no humidification/dehumidification occurs.

## Humidity Integration Time

Adjusts unit capacity based on the length of time the humidity has deviated from the setpoint. Works in conjunction with the proportional band to maintain tight setpoint control.

## Humidity Proportional Band

Adjusts the activation point of humidifier/dehumidification components based on deviation from setpoint by placing half of the selected value on each side of the humidity control setpoint. A smaller number causes faster reaction to humidity changes.

## Humidity Setpoint

Humidity level by adding moisture to or removing moisture from the air.

## Humidity Setpoint 2

Alternate setpoint activated by customer input (remote alarm device). When customer input connection is 2nd Setpoint, this value becomes the active humidity setpoint.

### 3.1.9 Humidity Control

Humidity control refers to the cooling unit’s response to programmed setpoints and sensed humidity conditions.

Vertiv™ Liebert® iCOM™ controls humidity based on temperature and humidity sensor readings. The requirement is expressed as a percentage and is calculated using the selected humidity control type.

#### Humidity Proportional Band

Use the proportional and dead-band parameters to control how your cooling unit(s) respond based on the calculated need for humidification/dehumidification. As the return air humidity deviates from the humidity setpoint, Liebert® iCOM™ responds with a humidification or dehumidification capacity of 0% to 100% in 1% increments.

Figure 3.11 below, illustrates humidity control using:

- 50% setpoint
- 8% proportional band
- No deadband

The proportional band is divided evenly on each side of the setpoint.

- 0% humidifying capacity is required at the humidity setpoint.
- The humidifier starts operating when the humidification requirement reaches 100% and continues to operate until the humidification requirement drops to 0%. During this period, the display shows 100% humidification
- The dehumidifying capacity responds in the same way as the return-air humidity rises above the setpoint. Dehumidification is accomplished by a request for cooling that activates as soon as the required dehumidifying capacity reaches 100% and continues operating until the required dehumidifying capacity drops to 0%. During this period, the digital compressor loading scales between a minimum percentage (advanced setting is A557) and 100% depending upon required dehumidifying capacity. The display always shows 100% dehumidification.

Figure 3.11 Humidity Control without a Deadband

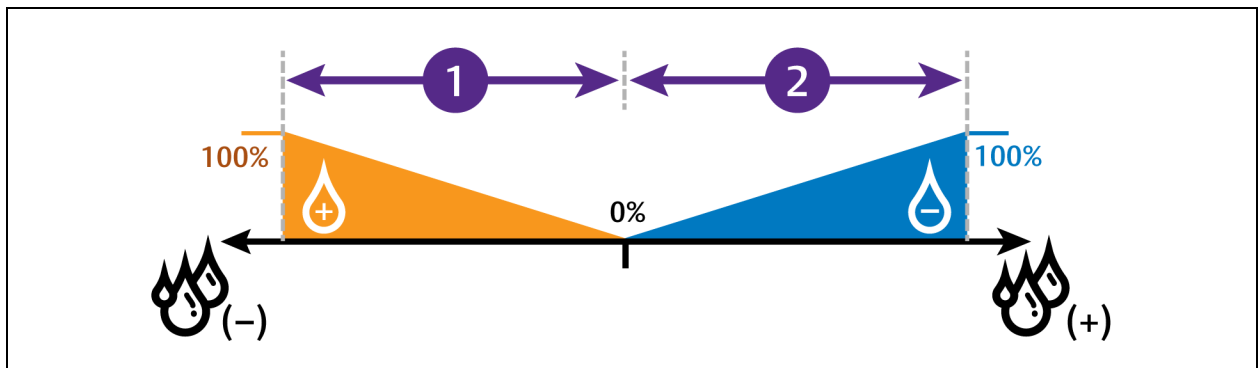

No.	Description
1	½ of proportional band.
2	½ of proportional band.

## Humidity Deadband

A deadband widens the setpoint to prevent small changes in humidity from activating humidifiers, compressors and valves and cause excessive component cycling.

Figure 3.12 below, illustrates humidity control using:

- 50% setpoint
- 8% proportional band
- 2% deadband

Like the proportional band, the deadband is also divided evenly on each side of the setpoint.

- 0% cooling capacity is required from 49% to 51%.
- Below 49%, humidification operates according to the humidity proportional band.
- Above 51%, dehumidification operates according to the humidity proportional band.

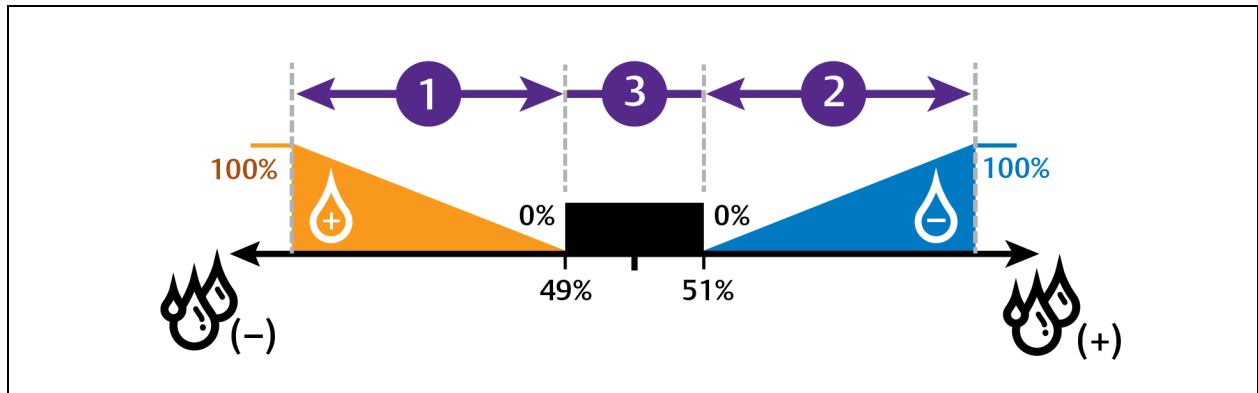

Figure 3.12 Humidity Control with a Deadband



No.	Description
1	½ of proportional band.
2	½ of proportional band.
3	Deadband.

### 3.1.10 Configuring Fan Setpoints

Configures fan-speed control to operate independent of compressor loading (decoupled mode).

1. Touch , then  > *Setpoints* > *Fan Control*. The FAN CONTROL secondary panel opens.
2. Adjust the setpoint options, then touch *Save*. The setpoint is updated.
  - Touch *Cancel* to discard the changes.

**NOTE:** Depending on the type of thermal management unit, included components, and control settings of your system, all of the options listed may not be available on your Vertiv™ Liebert® iCOM™ display.

## Fan Control Options

### Airflow Calibration

Maximum allowed fan output voltage.

### Fan Control Sensor

Selects the sensor that controls automatic fan speed, see [Automatic Fan Speed Control](#) on page 47,  
– or –

Selects manual control, see [Manual Fan Speed Control](#) on the facing page. Options are:

- Supply: Air flow/fan speed is adjusted based on reading from the supply air temperature sensor.
- Remote: Air flow/fan speed is adjusted based on reading from a wired, remote temperature sensor.
- Return: Air flow/fan speed is adjusted based on reading from the wired, return air temperature sensor.
- Manual: Air flow/fan speed is adjusted using a building-management system.

### Fan Control Type

Selects the method of control for the fan motor.

- Auto: Air flow/fan speed is adjusted using locally installed temperature sensors.
- Proportional: Regulation based on the difference between the fan control sensor reading and the fan setpoint.
- PI: Regulation is based on proportional and integral terms. Provides best temperature control and helps avoid fan speed oscillation.
- Adaptive PID: Auto-tuning PID control loop, can be set for cooling or fan speed.

### Fan Delta

Fan temperature setpoint, it is the temperature difference compared to the cooling setpoint.

### Fan Speed Proportional Band

Adjusts the fan speed based on the deviation from the setpoint. A smaller number causes faster reaction to temperature changes.

### Fan Speed Integration

Adjusts fan speed based on time away from the setpoint to maintain accurate temperature control.

### Maximum Fan Speed

Maximum percentage at which the fans will operate.

### Minimum Fan Speed

Minimum percentage at which the fans will operate.

### Static Pressure Deadband

Widens the setpoint to prevent small changes in static pressure from cycling the fan speed. When static pressure reading is within the deadband, no change in fan speed occurs



### Static Pressure Fan Control

Fan speed is controlled based on the static pressure setpoint and the static pressure reading from the sensor.

### Static Pressure Fan Speed P-band

Proportional band adjusts fan speed activation point based on a deviation from setpoint by placing half of the selected value on either side of the fan speed control setpoint. A smaller number causes a faster reaction in fan speed.

### Static Pressure Lower Range

Minimum threshold for static pressure. Defines the low end of the static pressure range.

### Static Pressure Setpoint

Static pressure that the unit maintains via fan speed. Expressed in inWC or Pa, depending on the unit of measurement selected.

### Static Pressure Upper Range





Maximum threshold for static pressure. Defines the high end of the static pressure range.

## 3.1.11 Manual Fan Speed Control





In Manual fan control mode, the speed of the motor can be set in one of the following ways:

- The manual (fixed) fan speed may be set via Vertiv™ Liebert® iCOM™.
- Hard wired analog input (input signal types including 4 to 20 mA, 0 to 10 VDC, and 0 to 5 VDC) and a factory-supplied isolator to ensure reliable communication.
- Remotely using a Vertiv™ Liebert® IntelliSlot™ card.

### Setting Manual Fan Speed Control via Analog Input

1. Touch , then  > *Setpoints* > *Fan Control*, set *Fan Control Sensor* to *Manual*, then touch *Save*.
2. Touch , then  > *Auxiliary Device Setup* > *Analog Input*.
3. On ANALOG INPUTS, touch *Customer Analog Inputs* to expand it, then touch the analog input device corresponding to fan-speed control.
4. On the ANALOG INPUT PROPERTIES panel, adjust the properties, then touch *Save*.
  - Touch *Cancel* to discard the changes without saving.

## Setting Manual Fan Speed Control via BMS

1. Touch , then  > *Setpoints > Fan Control*, set *Fan Control Type* to *Manual*, then touch *Save*.
2. Touch , then  > *BMS & Teamwork Setup > BMS Setup*.
3. On *BMS SETUP*, touch *Control Settings*. The *CONTROL SETTINGS* secondary panel displays:
  - In *Fan Control Sensor*, select *Manual*.
  - In *BMS Fan Speed Local Override*, select *No*.
  - Touch *Save*. BMS control of fan speed is set, and the BMS set fan speed is displayed on the *Fan Speed* slider.

## BMS Backup Fan Speed

Sets a fan speed % the unit shall ramp fanspeed at in the event of a BMS timeout. The end-user may select one of the following options for operation:

- Disabled - There is no reaction when BMS is disconnected. Unit shall remain as is.
- BMS Backup Spd - Fanspeed shall change to setting defined by parameter S162 BMS Backup Fanspeed when the BMS is disconnected.
- Coupled - Links the call for fanspeed percentage (%) to the call for cooling percentage (%). The fan shall still ramp between the minimum percentage and the STD speed percentage (MAX), still respecting the airflow calibration.
- BMS Backup Set - When configured, the current fan setpoint used for control (S147 Fan Setpoint) shall be replaced by value configured by Liebert® iCOM™ parameter S162 BMS Backup Fan Setpoint.
- SP Control - S146 Fan Control Sensor shall change back from Manual to Return and the static pressure related to the fan speed starts at the most recent BMS manual speed, eventually controlling to that speed.

The BMS timer must be configured for this setting to activate.

**NOTE:** Set the fan speed via BMS by writing to the "*Fan Speed Maximum Setpoint*" monitoring point. For details, see [SL-28170 IntelliSlot Reference Guide](https://www.vertiv.com/en-us/support/) found at <https://www.vertiv.com/en-us/support/>.

**NOTE:** Local adjustments to fan speed are overridden when remote/BMS fan speed control is set.

### 3.1.12 Automatic Fan Speed Control



Temperature sensors can control fan speed using one of three modes based on the type of sensor selected as the fan-control sensor: supply, return, or remote, see **Table 3.2** below. Control is based on the selected sensor for both fan control and temperature control and their setpoints as follows:

- Coupled: The fan control and temperature control sensor selection is the same. When coupled, fan speed and cooling capacity share the same temperature setpoint.
- Decoupled: The fan control and temperature control sensor selection is different. When decoupled, fan speed control and temperature control have separate setpoints and tunable PI loops.

**Table 3.2 Fan Speed Controlling Sensor Options**

		Temperature Control Sensor Selected		
		Supply Sensor	Remote Sensor	Return Sensor
Fan Control Sensor Selected	Supply Sensor	Coupled	Decoupled	Decoupled
	Remote Sensor	Decoupled (Recommended)	Coupled	N/A
	Return Sensor	Decoupled	N/A	Coupled



To set parameters for automatic fan speed control:

1. Touch , then  > *Setpoints* > *Fan Control*,
  - Set *Fan Control Type* to **Manual**
  - Select a *Fan Control Sensor*.
  - Adjust the setpoint options, then touch *Save*.

Sensor based fan speed control is set.

2. Touch *Temperature Control*.
3. On the TEMPERATURE CONTROL secondary panel:
  - Select a *Temperature Control Sensor*.
  - Adjust the setpoint options, then touch *Save*.

### 3.1.13 Configuring Static Pressure Setpoints

1. Touch , then  > *Setpoints* > *Static Pressure Settings*. The STATIC PRESSURE SETTINGS secondary panel opens.
2. Adjust the setpoint options described in the [Static Pressure Settings Options](#) on the next page, then touch *Save*. The setpoint is updated.
  - Touch *Cancel* to discard the changes.

**NOTE:** Depending on the type of thermal management unit, included components, and control settings of your system, all of the options listed may not be available on your Vertiv™ Liebert® iCOM™ display.

## Static Pressure Settings Options

### Current Override Temperature

Current temperature reading of the sensor selected for static pressure control override.

### Current Override Value

Percentage of override from 0% (no override/static pressure control only) to 100% (temperature-sensor reading overrides completely).

### Full Speed at

Temperature at which override reaches 100% and fan operates at full speed.

### Operation at Static Pressure Sensor Failure

Selects operation in the event that the static pressure sensor fails. Values are:

- Freeze Speed: Current fan speed is kept.
- SP Off: Static pressure control is disabled and fan speed is dictated by selected fan speed sensor.

### Override Integration Time

Adjusts amount of override based on the length of time the temperature has deviated from the setpoint.

### Override Slew Rate Filter

Rate of change filter to slow down fan speed changes.

### Static Pressure Control Override

Selects sensor that may override static pressure control if the temperature gets too far from the temperature setpoint to provide additional air flow because static pressure is not able to maintain the temperature. Values are:

- None: Override is disabled.
- Remote Sensor: The remote sensor overrides static pressure control.
- Return Sensor: The return sensor overrides static pressure control.

### Static Pressure Min Pause

Minimum initial length of time that fan speed stops increasing after the pressure reading crosses into the deadband. After the pause, the fan speed pulses (increases if below the setpoint and decreases if above the setpoint) for the period selected in the Static Pressure Pulse inside deadband field. After each pulse, a pause takes place, the length of which is calculated as a ratio between the deadband border (minimum) and the setpoint (maximum).

### Static Pressure Max Pause

Maximum initial length of time that fan speed stops increasing after the pressure reading crosses into the deadband. After the pause, the fan speed pulses (increases if below the setpoint and decreases if above the setpoint) for the period selected in the Static Pressure Pulse inside deadband field. After each pulse, a pause takes place, the length of which is calculated as a ratio between the deadband border (minimum) and the setpoint (maximum).

### Static Pressure Pulse Inside Deadband

Period of time the fan speed increases or decreases (pulses) when pressure is inside the deadband.

### Static Pressure Requested Speed Up To

Temperature at which static pressure control override begins.

## 3.1.14 Supply Sensor Aggregation

When more than one supply air sensor is required to be used for cooling capacity control (temperature control), the Supply Sensor Aggregation feature may be enabled. Supply Sensor Aggregation feature allows the use of multiple temperature sensors which are programmed to create a single, aggregated supply air temperature value which may be used for cooling capacity control.

Vertiv™ Liebert® iCOM™ shall support a maximum of (6) sensors for Supply Sensor Aggregation calculation. Up to (5) additional remote 2T sensors may be connected to a given Liebert® iCOM™ controller and programmed for Supply Sensor Aggregation. The standard Supply NTC sensor may also be included/excluded in the aggregated supply temperature calculation Liebert® iCOM™. The end user shall have the ability to determine whether the supply sensor aggregation calculated value is based on the Average of all the sensor values or Maximum (worst case) temperature reading. Invalid sensor readings will not affect the unit calculation (they will be excluded).

### Enabling Supply Sensor Aggregation

Via the Liebert® iCOM™ display, navigate to Service Menu > Auxiliary Device Setup > Sensors > Supply Sensor Aggregation Setup.

Figure 3.13 Enabling Supply Sensor Aggregation

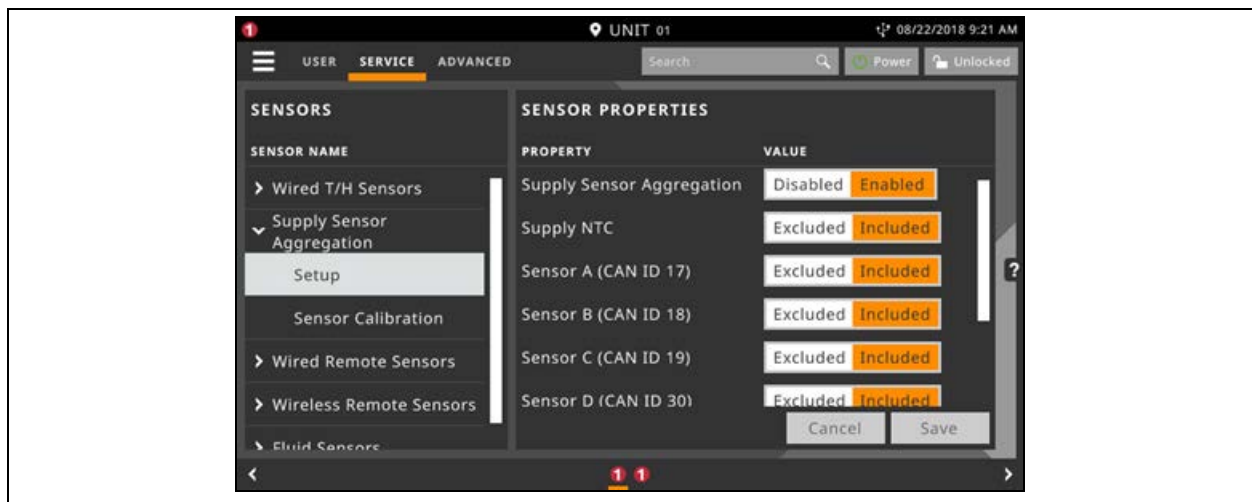

The additional Remote 2T sensors must be properly addressed in order to be used in this calculation. The standard addressing of these sensors differs from that of the (10) additional remote 2T sensors Liebert® iCOM™ also supports. The end-user shall have the ability to determine which of the connected sensors may be included/excluded in the Supply Sensor Aggregation calculation via the toggle shown in the image above. End-users will also the capability of calibrating each sensor.

The information below represents the CANbus addressing of the additional remote sensors which shall be used for Supply Sensor Aggregation calculation:

**Table 3.3 Supply Sensor Aggregation Calculation**

Sensor	CANbus Node	Dip Switch Position SW1-1	Dip Switch Position SW1-2	Dip Switch Position SW1-3	Dip Switch Position SW1-4	Dip Switch Position SW1-5	Dip Switch Position SW1-6
Sensor A	17	ON	OFF	OFF	OFF	ON	OFF
Sensor B	18	OFF	ON	OFF	OFF	ON	OFF
Sensor C	19	ON	ON	OFF	OFF	ON	OFF
Sensor D	30	OFF	ON	ON	ON	ON	OFF
Sensor E	31	ON	ON	ON	ON	ON	OFF

**NOTE: Sensor A-C may be Remote T/H or Remote 2T sensors. Sensors D and E must be Remote 2T sensors.**

**NOTE: Sensor A may be used to provide a single Supply Humidity (%) reading by Including when utilizing Supply Sensor Aggregation. This humidity reading is reference-only and may not be used for control.**

## 3.2 Scheduling Condenser and Cooling Unit Tasks



The Scheduler configures operating conditions and modes for specific intervals. Tasks to schedule include:

- Condenser set back: See [Scheduling Condenser Low Noise Operation](#) below .
- Condenser fan reversal: See [Scheduling Condenser Fan Reversal](#) on the facing page .
- Unit sleep schedule: Turns off units during times of low demand and controlled only by temperature. Sleep is interrupted if the return temperature rises above the alarm threshold.

### 3.2.1 Scheduling Condenser Low Noise Operation

Condenser setback schedules low noise fan operation on units equipped with Vertiv™ Liebert® MC premium efficiency control. Fans spin more slowly during specified times to reduce noise, and faster when low noise is unnecessary.

**NOTE: Low noise operation is overridden to prevent a high pressure condition.**

1. Touch , then  > Scheduler > Condenser Setback Schedule. The TASK PROPERTIES panel opens.
2. Adjust the schedule settings, and touch Save. The schedule is set up.
  - Touch *Cancel* to discard the changes.

## Condenser Setback Task Properties Options

### Disabled Day

Selects specific days on which noise-reduction operation is disabled when the schedule is enabled.

### Interval 1

Start and finish time of day that noise-reduction operates.

### Interval Day

Selects days on which noise reduction operation for the interval specified in Interval 1.

### Max Speed in Low Noise Mode

Sets the maximum speed for the condenser fan during low noise operation.

### Max Speed in Normal Mode

Sets the maximum speed for the condenser fan during normal or high efficiency operation.

### Noise Reduction

Enable/disable noise reduction. When checked, the schedule is run. When unchecked, the scheduling parameters are ignored.

### Status



Indicates if low noise operation is active or inactive.

### Whole Day

Selects whole days for which noise reduction operation is available for the condenser fan.

## 3.2.2 Scheduling Condenser Fan Reversal

Condenser fan reversal schedules a reversal of the condenser fans, reversing air flow to help remove dust, paper, leaves and such from the suction side of the condenser coil.

1. Touch , then  > *Scheduler* > *Condenser Fan Reversal Schedule*. The TASK PROPERTIES panel opens.
2. Adjust the schedule settings, and touch *Save*. The schedule is set up.
  - Touch *Cancel* to discard the changes.

## Condenser Fan Reversal Task Properties Options

### Reverse Fans At Duration

Length of time, in seconds, the fans are reversed.

### Reverse Fans Every



Selects number of days between fan reversal.

### Reverse Fans Now

Enables/disables immediate fan reversal.

## 3.2.3 Scheduling Sleep Times for Thermal Management Units

Unit sleep schedules turn off units during low demand as long as return temperature remains below the alarm threshold.

1. Touch , then  > *Scheduler* > *Unit Sleep Schedule*. The TASK PROPERTIES panel opens.
2. Adjust the schedule settings, and touch *Save*. The schedule is set up.
  - Touch *Cancel* to discard the changes.

## Unit Sleep Schedule Task Properties Options

### Interval 1/2

Start and finish time of day that sleep mode operates.

### Interval Day

Selects days on which sleep mode operates for the intervals specified in Interval 1 and Interval 2.

### Sleep Mode

Enable/disable sleep schedule. When checked, the schedule is run. When un-checked, the scheduling parameters are ignored.

### Timer Mode Type

Selects unit operation when in sleep mode. Values are:

- Unit Off: The unit stops (fans are off).
- Deadband: The unit operates in a limited capacity (fans are on) based on an additional deadband added to the temperature deadband.

### Timer Reset

Selects whether or not the sleep mode timer resets.

### Whole Day



Selects specific days on which sleep mode is active for the entire day when the schedule is enabled.



## 3.3 Setting General Thermal Management Unit Options

**NOTE:** Depending on the type of thermal management unit, included components, and control settings of your system, all of the options listed may not be available on your Vertiv™ Liebert® iCOM™ display.

### 3.3.1 Setting Miscellaneous Options

1. Touch , then  > *Options Setup* > *Misc Settings*. The MISC SETTINGS panel displays.
2. Make adjustments as needed and click *Save*. The option settings are updated.
  - Touch *Cancel* to discard the changes without saving.

**NOTE:** Depending on the type of thermal management unit, included components, and control settings of your system, all of the options listed may not be available on your Vertiv™ Liebert® iCOM™ display.

#### Miscellaneous Cooling Unit Settings Options

##### Auto Restart Enable

When enabled, the cooling unit returns to the status at which it was operating when input power returns after a power failure. (ON if it was powered on and OFF if it was powered off before the failure.) See [Automatic Restart after Power Failure](#) on page 56.

##### Cascade after Remote On

Upon a remote request for all units to start, selects whether or not the units start one after another by the Cascade Units Delay set in [Teamwork Modes](#) on page 101, see the [Teamwork Control Options](#) on page 103.

##### Freecool Capacity Transition Filter

Selects how quickly capacity changes between modes of operation to avoid overshooting during the transition.

- Only a factory-trained service technician should adjust this setting.

##### K11 Active on

Selects the action of the activated K11 (warning) relay. Options are:

- Dehum: Dehumidification is on.
- Warning: A warning is active.
- Emergency Pwr: Emergency power is on.
- Freecooling: Freecooling is on.
- FC Start: Freecooling is in the start phase or is on.

##### Loss of Power Autoreset Delay

Selects the length of time that a Loss of Power event (that triggers after a power cycle that occurs when the cooling unit is operating) is active when power is restored. When the delay time elapses, the event resets and is cleared automatically.

### Operation at Temp Control Sensor Failure

Selects cooling unit operation in the event that the control temperature sensor fails.

- Shut Down: The unit shuts down on sensor failure.
- Cooling: The unit continues operation based on the select Temp Control Sensor Failure Cooling Mode.

### Single Unit Auto Restart

Selects time elapsed (in seconds) before unit restarts when Auto Restart Enable is enabled.

### Temp Control Sensor Failure Cooling Mode

Unit operation when Cooling is selected at control temperature sensor failure.

- Hold: Holds the last call for cooling. That is, continue operating at same capacity.
- Full: Activates full cooling, 100% capacity.



### Warning Activates Alarm Relay

When enabled, a warning event activates the common alarm relay.

## 3.3.2 Configuring Quick Start

In the event of a power interruption to the Vertiv™ Liebert® iCOM™ controller, the unit components and controls shut down. Normally, after power is restored, the Liebert® iCOM™ controller must fully boot, and no cooling or air flow occurs until the controls have fully booted. Quick Start lets you determine the fan and cooling output that the unit will provide before the controller fully boots. When configured, the unit can provide airflow and cooling within 10 seconds after power is restored to the controller. Quick Start can be applied to fan, chilled-water, DX, and PRE-pump functions. Quick Start operates only during Liebert® iCOM™ application boot, then normal controller operation resumes.

### To Configure Quick Start

1. Touch  , then  > *Options Setup* > *Quick Start Settings*. The QUICK START SETTINGS panel displays.
2. Refer to [Quick Start Options](#) below , and select the configuration options for your system.

**NOTE:** Depending on the type of thermal management unit, included components, and control settings of your system, all of the options listed may not be available on your Liebert® iCOM™ display.

### Quick Start Options

#### CW Quick Start

Enables/disables chilled water quick start.

#### CW Quick Start Delay

Delay before chilled water function activates after power is restored (0 to 180 seconds).

#### CW Valve 1 Analog Output

Position percentage open of chilled water valve 1 during quick start operation (0 – 100%).

**CW Valve 1 Digital Output**

Enables/disables output from chilled water valve 1 during quick start.

**CW Valve 2 Analog Output**

Position percentage open of chilled water valve 2 during quick start operation (0 – 100%).

**CW Valve 2 Digital Output**

Enables/disables output from chilled water valve 2 during quick start.

**DX Quick Start**

Enables/disables DX quick start.

**DX Quick Start Initial Call for Cooling**

Compressor output percentage (call for cooling) during quick start operation (0 – 100%).

**DX Quick Start with Econophase**

Enables/disable Liebert® EconoPhase operation during quick start. When enabled on Vertiv™ Liebert® DSE thermal management units, note the following:

- If unit was operating in pump mode at the time of power loss, unit restarts in pump mode.
- If unit was operating in mixed mode at the time of power loss, unit restarts in mixed mode.
- If unit was operating in compressor mode at the time of power loss, unit restarts in compressor mode.

**Fan Quick Start**

Enables/disables fan quick start.

**Pump Start Call For Cooling**

Output percentage of PRE pump quick start operation (50 – 100%).

**Quick Start Delay**

Delay before quick start activates after power is restored (0 to 180 sec).

**NOTE: When using DX quick start, you must configure a minimum of 40 seconds to allow time for global condenser communication to establish before the compressors are powered on.**

**Quick Start Fan Analog Output**



Fan speed percentage during quick start operation.

**Quick Start Overlap Time**

Length of time quick start fan speed overlaps normal fan speeds settings. After fully booted, normal fan speed control resumes when this time expires.

### 3.3.3 Automatic Restart after Power Failure



Set the cooling unit to return to the status at which it was operating when input power returns after a power failure. (ON if it was powered on and OFF if it was powered off before the failure.)

1. Touch , then  > *Options Setup* > *Misc Settings*. The MISC SETTINGS panel displays.
2. Set *Auto Restart Enable* to *Yes*, and use the slider to set the number of seconds to delay before restart, then touch *Save*. Automatic restart is enabled.
  - Touch *Cancel* to discard the changes without saving.

### 3.3.4 Setting Fan Options

Air flow is adjustable via Vertiv™ Liebert® iCOM™ manually using a building management system (BMS) or automatically using locally installed temperature sensors.

**NOTE: Thermal management units ship with the factory setting Return Sensor for the temperature control sensor and the fan speed control sensor.**

1. Touch , then  > *Options Setup* > *Fan Settings*. The FAN SETTINGS panel displays.
2. Make adjustments as needed and click *Save*. The option settings are updated.
  - Touch *Cancel* to discard the changes without saving.

**NOTE: Depending on the type of thermal management unit, included components, and control settings of your system, all of the options listed may not be available on your Vertiv™ Liebert® iCOM™ display.**

## Fan Settings Options

### Airflow Calibration

Maximum allowed fan output voltage.

### Allow Fan Modulation with Comp

Enables/disables fan modulation with compressor operation. Values are:

- No: Fan speed ramps to STD when a compressor starts operating.
- Yes: Fan speed modulates based on CFF while compressor operates.

### Dehumidification Fanspeed

Maximum fan speed when dehumidification is in progress, assisting with the dehumidification process.

### Fan Back Draft Mode

Enables/disables fan operation in back draft mode.

**Fan Shutdown Delay Timer**

Length of time that the fan continues to operate after the cooling unit is turned off via the display, local control or the BMS.

The delay timer does not apply when the unit is turned off remotely.

**Fanspeed at Unit Start**

Speed at which the fans run on unit start up.

**Fanspeed at Unit Start Timer**

Length of time fans run at the speed selected in fan speed at unit start.

**Fanspeed Filter at 0%**

Decreases the rate at which the fan speed changes when close to or at the temperature setpoint to avoid undershooting the setpoint.

**Fanspeed Filter at 100%**

Increases the rate at which the fan speed changes for a quicker reaction of fan speed at high temperatures.

**Fanspeed Reposition Delay**

Length of time before fan speed can decrease, allowing temperature to stabilize before the change occurs.

**Fanspeed Reposition Mode**

Sets a one time delay that allows the fan to maintain current speed when a call to increase or decrease is made to allow the temperature to stabilize.

**Fanspeed Transition Filter**

Sets how quickly the fan speed changes between operating modes. Prevents an instant reaction when fans turn on or off and prevents unstable operation.

**Max Deceleration Rate**

Selects the rate and which the fan speed changes during deceleration.

**Maximum Fan Speed**

Maximum speed at which the fan will operate.

**MIN at CFC for EC Fan**

Cooling deviation at which the fan will operate at minimum speed.

**Minimum Fanspeed**

Minimum speed at which the fan will operate.



**No Power Fanspeed**

Speed at which the fans operate when using emergency power.

**STD at CFC for EC Fan**

Cooling deviation at which the fan will operate at maximum speed.

**3.3.5 Setting Compressor Options**

1. Touch , then  > *Options Setup* > *Compressor Settings*. The COMPRESSOR SETTINGS panel displays.
2. Make adjustments as needed and click *Save*. The option settings are updated.
  - Touch *Cancel* to discard the changes without saving.

**NOTE:** Depending on the type of thermal management unit, included components, and control settings of your system, all of the options listed may not be available on your Vertiv™ Liebert® iCOM™ display.

**Compressor Settings Options****Ball Valve Setpoint Offset**

Adjusts sensitivity to compressor discharge pressure or liquid pressure by increasing sensitivity. The higher the added pressure, the more the valve opens.

**Capacity Change at 0%**

Decreases the rate at which cooling capacity changes when close to or at the temperature setpoint to avoid undershooting the setpoint.

**Capacity Change at 100%**

Increases the rate at which the cooling capacity changes for a quicker reaction of cooling at high temperatures.

**Compressor Sequence**

Selects the lead compressor when cooling activates. Values are:

- Auto: Compressor with the lowest run hours leads.
- 1: Compressor 1 leads.
- 2: Compressor 2 leads.



**Winter Start Delay**

Length of time, in minutes, that a low pressure condition is ignored during compressor start-up. See [Setting Low Pressure Time Delay](#) on the facing page .

## Setting Low Pressure Time Delay

At compressor start up, a low pressure condition is ignored for a set period to avoid false trips due to bubbles in the refrigerant or other misreading of the low pressure device.



**NOTE: The factory-default setting is a three minute delay for air cooled units and a zero to one minute delay for water cooled units.**

1. Touch , then  > *Options Setup* > *Compressor Settings*.
2. Use the *Winter Start Delay* slider to select the number of minutes for the delay, and touch *Save*.

## Adjusting Ball Valve Pressure Offset

**NOTE: Only a properly trained and qualified technician should modify the motorized ball valve setting.**

The number of times the valve opens and closes is adjusted based on added pressure offset.

1. Touch , then  > *Options Setup* > *Compressor Settings*.
2. Use the *Ball Valve Setpoint Offset* slider to select amount of pressure added to open the valve wider, and touch *Save*.

## Compressor Sequencing for Balancing Run Times



Compressor sequencing, available in two compressor cooling units, allows assigning a lead compressor or allowing automatically leading with the compressor with the lower run hours logged.

When Auto is selected, the following applies as Liebert® iCOM™ attempts to maintain equal run time of the compressors:

- If only one compressor is available because of safety delays, it is given first priority to start/stop.
- If both compressors are off, the compressor with fewer run-hours in the next to start.
- If both compressors are operating, the compressor operating for the longest time since the last start is the first to shut off.



**NOTE: Automatic compressor sequencing will not power off a compressor if it is required to properly condition the space.**

To set-up compressor sequencing:

1. Touch , then  > *Options Setup* > *Compressor Settings*.
2. Select the *Compressor Sequence* option to use, and touch *Save*.

### 3.3.6 Setting Reheat Options

If the room air temperature becomes too cold, heating is activated based on the temperature proportional band setting. Depending on the type of cooling unit, there are different types of reheat (configured at purchase/set at factory). There may also be one to three stages of reheat, which are also factory set. The only service operation available is setting the number of heat stages.

1. Touch , then  > *Options Setup* > *Reheat Settings*.  
The REHEAT SETTINGS panel displays.
2. Refer to [Reheat Settings Options](#) below, and [Reheat Control](#) on the facing page to adjust the setpoint options, then touch *Save*.  
The option settings are updated.
  - Touch *Cancel* to discard the changes without saving.

#### Reheat Settings Options

##### Electric Heat Outputs

Shifts the output steps of the electric heaters.

##### Electric Heat Staging

Selects the number of stages available during reheat operation.

##### Enable Hot Gas Heat

Enables/Disables hot gas reheat. (May not be included on your cooling unit.) See [Reheat Control](#) on the facing page.  
Values are:

- No: Hot gas reheat disabled.
- Comp. 1: Use compressor 1.
- Comp. 2: Use compressor 2

##### Enable Hot Water Flush

Selects the number of hours between hot water coil flush cycle.

##### Enable Hot Water Heat

Enables/disables hot water reheat. (May not be included on your cooling unit.)

##### Enable Rotation

Enables/disables rotation of multiple heaters.

##### Reheat Operation

Selects when heating is allowed.

- Dehum: Heating only allowed during dehumidification.
- Normal: Heating allowed during all operating modes.



### SCR Control Type

Enables/disables SCR reheat. (May not be included on your cooling unit.) See [Reheat Control](#) below . Values are:

- None: SCR reheat disabled.
- Tight: Use tight control reheat mode.
- Standard: Use standard reheat mode.

### Electric Heat Stages

Number of electric stages that may be activated during reheat.

- Depending on your cooling unit, the maximum setting may be 1, 2, or 3.

## 3.3.7 Reheat Control

If your cooling units are equipped with a heating option, reheat control is directly linked to temperature control in that the heating requirement determined by the temperature proportional band determines reheat operation. See [Temperature Control—Temperature Setpoints and Cooling Operation](#) on page 27 .

### Electric, Hot Gas, and Hot Water Reheat

Depending on the type of cooling unit, there may be one to three stages of electric and hot gas/hot water reheat. **Table 3.4** below , shows the nine electric reheat options.

**Table 3.4 Electric, Hot Gas and Hot Water Reheat Configurations**

Type	Stage 1	Stage 2	Stage 3
A	Electric 1	—	—
B	Electric 1	Electric 2	—
C	Electric 1	Electric 2	Electric 3
D	Hot gas	—	—
E	Hot gas	Electric 1	—
F	Hot gas	Electric 1	Electric 2
G	Hot water	—	—
H	Hot water	Electric 1	—
I	Hot water	Electric 1	Electric 2

**NOTE: During dehumidification, hot gas/hot water are not influenced by the electric reheat setting. Hot gas is set only when the selected compressor is operating. (See [Enable Hot Gas Heat](#) on the previous page .)**

Reheat is controlled by dividing the “heating” half of the temperature proportional band (below the setpoint) by the number of stages. **Figure 3.14** on the next page , illustrates electric reheat operation with three stages as follows:

- 70° setpoint
- 8° proportional band
- 2° deadband
- Three stage reheat

The proportional band is divided evenly on each side of the setpoint. The deadband is divided evenly on each side of the setpoint. The temperature proportional band below the setpoint is divided into thirds, one for each stage.

- From 70° to 69°, 0% heating is required.
- At 68.7° air temperature (heating demand 33%), stage 1 activates and continues operating until temperature reaches 69°.
- When temperature decreases to 67.4° (heating demand 66%), stage 2 activates, and continues until temperature reaches 68.7° (heating demand 33%).
- When temperature decreases to 67.4° (heating demand 100%), stage 2 activates, and continues until temperature reaches 68.7° (heating demand 66%).
- When temperature decreases to 63° (heating demand 100%), stage 3 activates, and continues until temperature reaches 67.4° (heating demand 33%).

**Figure 3.14 Temperature Control for Reheat—Three Stage Electric Reheat**

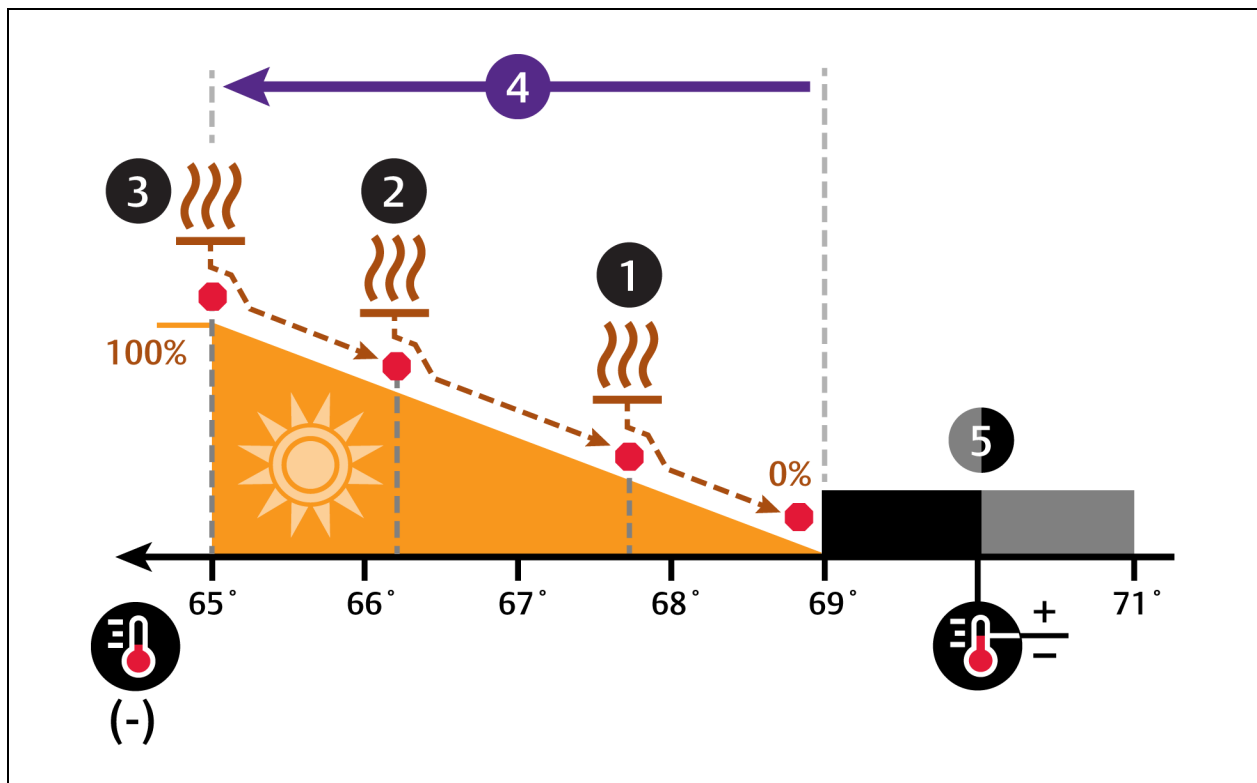

No.	Description	No.	Description
1	Stage 1 reheat.	4	½ of proportional band.
2	Stage 2 reheat.	5	Deadband.
3	Stage 3 reheat.		

**SCR Reheat**

SCR reheat uses pulsed on/off operation to modulate heating capacity to control temperature more precisely than staged, electric reheat. 100% heating capacity is constant operation of SCR reheat. As the temperature proportional band requires more heat, the SCR output adjusts proportionally.

**SCR Reheat—Standard Mode**

**NOTE:** Standard SCR Reheat when used in conjunction with variable cooling capacity (such as chilled water, variable speed fans or digital scroll compressors) provides ultimate capacity control and energy efficiency gains.

In standard mode, SCR reheat responds to a 0% to 100% heating requirement based on the temperature proportional band.

Figure 3.15 below, illustrates SCR reheat in standard mode as follows:

- 70° setpoint
- 8° proportional band
- No deadband

The proportional band is divided evenly on each side of the setpoint. The deadband is divided evenly on each side of the setpoint.

- At 70° air temperature (heating demand 0%), no heating occurs.
- When temperature decreases below the setpoint, SCR reheat activates, and increases output as the heating demand increases from 0% to 100%.
- As air temperature rises and heating demand decreases, the SCR reduces output and stops operating when 70° (0% heading demand) is reached.

**Figure 3.15 Temperature Control for Reheat—SCR in Standard Mode**

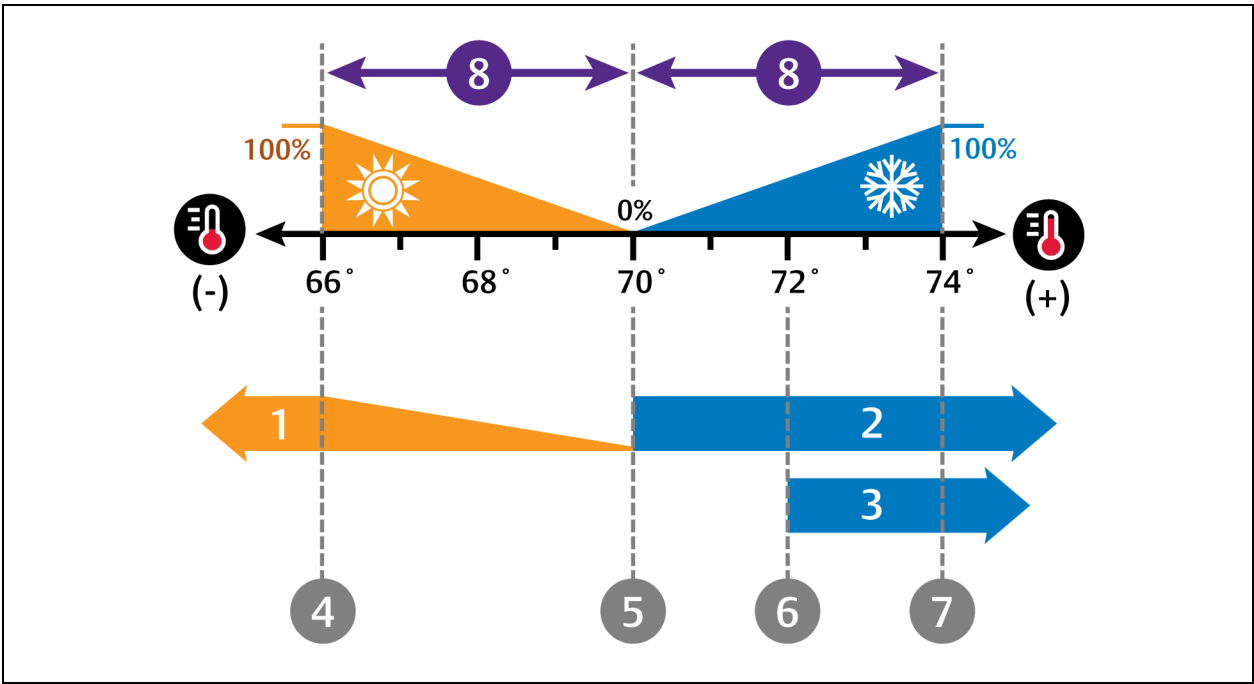

No.	Description	No.	Description
1	SCR reheat operation.	5	SCR reheat stops/begins operating at the setpoint. Compressor 1 begins/stops operation at the setpoint.
2	Compressor 1 operation.	6	Compressor 2 stops operating.
3	Compressor 2 operation.	7	Compressor 2 begins operating.
4	SCR reheat output is 100%.	8	½ of proportional band.

## SCR Reheat—Tight Mode

In tight mode, cooling (compressors) and heating (SCR reheat) components operate simultaneously to provide maximum temperature control.

**NOTE: Tight mode is the factory default setting when available. Tight mode is not available on chilled water units, units with variable speed fans or units with digital scroll compressors.**

The compressor(s) respond to a 0% to 100% cooling requirement and the SCR responds to a 0% to 200% heating requirement based on the temperature proportional band. **Figure 3.16** on the facing page, illustrates SCR reheat on a system with two single-step compressors operating in tight mode as follows:

- 70° setpoint
- 8° proportional band
- No deadband

The proportional band is divided evenly on each side of the setpoint, and an additional half of the proportional band is added to the heating side for 200% heating.

- At 70° air temperature (heating demand 0%), SCR reheat operates at full capacity and compressor 1 operates continuously from 100% cooling demand to 200% heating demand.
- At 200% heating demand, compressor 1 deactivates until the temperature increases to 70° setpoint (0% heating/cooling demand).
- As cooling demand increases from 0% to 100%, SCR reduces heating capacity proportionally and stops operating at 100% cooling demand.
- At 100% cooling demand, compressor 2 starts and operates until the air temperature returns to 70° (0% cooling demand) when it stops operation.

– at the same time –

SCR increases heating capacity as the cooling demand decreases from 100% to 0%.

- When temperature decreases below the setpoint, SCR operates at full capacity as the air temperature drops and heating demand increases from 0% to 200%.

**NOTE: Some cooling units are not suited for a strict, NO LOAD application and require a minimal load in the space. Consult a Vertiv™ representative for verification.**

Figure 3.16 Temperature Control for Reheat—SCR in Tight Mode

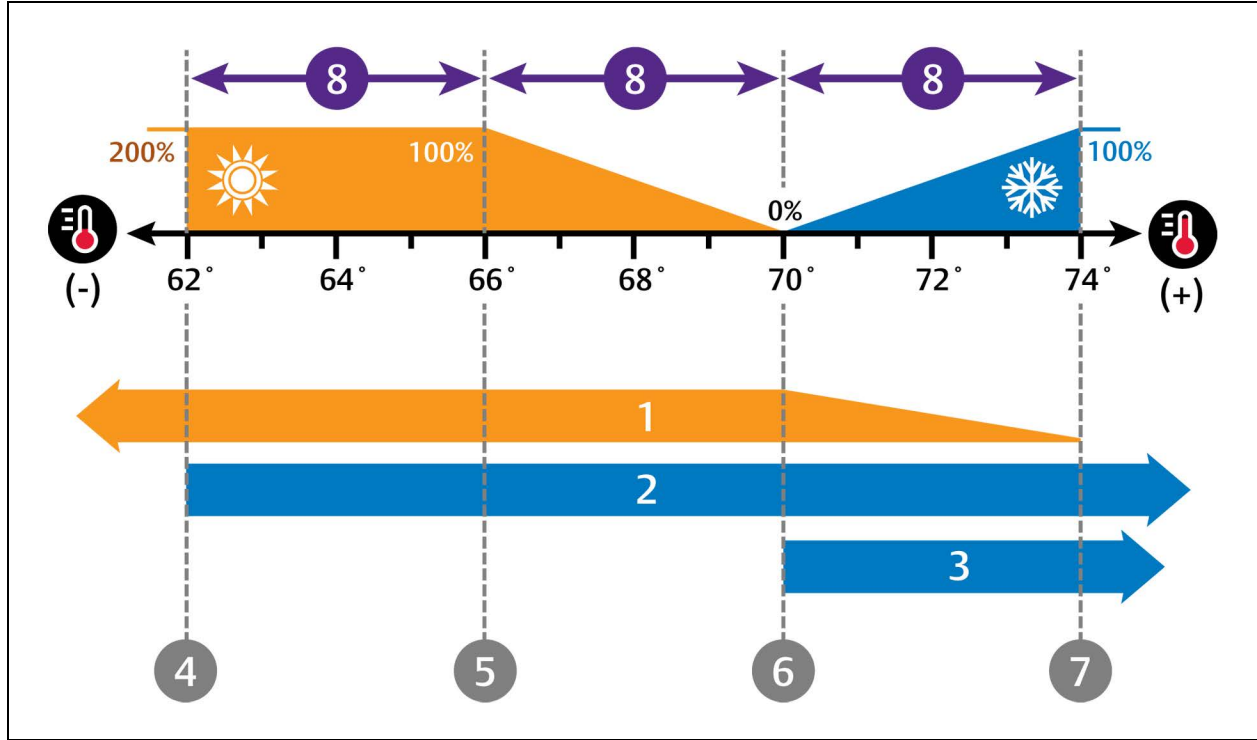



No.	Description	No.	Description
1	SCR reheat operation.	5	100% heating.
2	Compressor 1 operation.	6	SCR reheat capacity is decreased as temperature nears 100% cooling, and compressor 2 stops operating.
3	Compressor 2 operation.	7	SCR reheat stops operating, and Cooling begins operating.
4	SCR reheat is operates at full capacity from 0% to 200% heating, and compressor 1 stops operating at 200% heating and remains inactive until temperature returns to the setpoint.	8	½ of proportional band.

### 3.3.8 Setting Humidifier Options

The type of humidifier used depends on the cooling unit model and application requirements for your system.

**NOTE:** Except for externally mounted humidifiers, humidifier operation is limited by the return air temperature. If return air temperature reaches 80°F (26°C) or higher, the humidifier is disabled. The humidifier will not resume operation until the temperature falls to 75°F (24°C) or remains below 80°F (26°C) for 20 minutes.

1. Touch , then  > *Options Setup* > *Humidifier Settings*. The HUMIDIFIER SETTINGS panel displays.
2. Make adjustments as needed and click *Save*. The option settings are updated.
  - Touch *Cancel* to discard the changes without saving.

**NOTE:** Depending on the type of thermal management unit, included components, and control settings of your system, all of the options listed may not be available on your Vertiv™ Liebert® iCOM™ display.

## Humidifier Settings Options

### Humidification System Enabled

Enables/disables group wide (network wide) humidification by the cooling units in the group. Once enabled at the system level, individual units may be enabled using the Humidification Unit Enabled parameter.

### Humidification Unit Enabled

Enables/disables humidification at the unit level.

### Humidifier Control

Controls humidifier operation.

- Proportional: Calculates based on humidification setpoints.
- On-Off: Sends a start-stop command to a remote mounted humidifier.

### Humidifier Model

The type of humidifier installed.



### Humidifier Steam Rate

Selects capacity of steam generation.

### Infrared Flush Rate

Adjustable rate of flush for the infrared humidifier, range 110 %to 500%.

## 3.3.9 Setting Dehumidification Options

1. Touch , then  > *Options Setup* > *Dehumidification Settings*. The DEHUMIDIFICATION SETTINGS panel displays.
2. Make adjustments as needed and click *Save*. The option settings are updated.
  - Touch *Cancel* to discard the changes without saving.

**NOTE:** Depending on the type of thermal management unit, included components, and control settings of your system, all of the options listed may not be available on your Vertiv™ Liebert® iCOM™ display.

## Dehumidification Settings Options

### Capacity Increase on Dehum

Capacity increase permitted during dehumidification.

### Dehum Fan Ctrl

Enables/disables fan-speed operation during dehumidification.

### Dehum System Enabled

Enables/disables whether or not the compressor/valve is used for dehumidification when humidity is above the setpoint.



### Dehum Timer

Length of time, in minutes, the dehumidifier may operate.

### Dehum Unit Enabled

Enables/disables dehumidification for the cooling unit.

## 3.3.10 Setting Water Leak Detector Options

1. Touch , then  > *Options Setup* > *Water Leak Detector*. The WATER LEAKAGE DETECTOR panel displays.
2. Make adjustments as needed and click *Save*. The option settings are updated.
  - Touch *Cancel* to discard the changes without saving.



**NOTE:** Depending on the type of thermal management unit, included components, and control settings of your system, all of the options listed may not be available on your Vertiv™ Liebert® iCOM™ display.

## Water Leak Detector Settings Options

### Water Detector

Type of water leak detector installed.

## 3.3.11 Setting Q15 Options

1. Touch , then  > *Options Setup* > *Q15 Settings*. The Q15 SETTINGS panel displays.
2. Make adjustments as needed and click *Save*. The option settings are updated.
  - Touch *Cancel* to discard the changes without saving.

## Q15 Settings Options

### Damper Switch Feedback Timer

If output function is Damper and End Switch, the length of time Vertiv™ Liebert® iCOM™ waits for the feedback signal from the damper motor, that is, if it is open or closed.

### Fan Delay for Damper

Length of time that must elapse during damper opening/closing. During this span, all functions associated with the on/off state are eligible.

### Medium Board: Q15 Map to K11

Maps the Q15 function to the K11 (warning) relay because a medium-sized board does not have Q15 output.

### Q15 Output Direction

Selects whether the output is normally on or normally off.

### Q15 Output Function

Selects the reason for which the digital output is activated. Options are:

- 1: Dehum On
- 3: Reheat On
- 4: Comp On
- 5: Comp 1 On
- 6: Comp 2 On
- 7: Humi On
- 9: Free Cool On
- 10: Damper
- 11: High Temp
- 12: Low Temp
- 13: Loss Power
- 14: Power Source

### Q15 Output Sensor

Selects a sensor reading to compare to the set threshold that activates Q15 output. Options are:

- 0: Return
- 1: Supply
- 2: Rem Max
- 3: Rem Low
- 4: Rem Avg

### Q15 Output State

Status of Q15 output, on or off.



**Q15 Temp Actual**

Current value of the sensor selected as the Q15 Output Sensor.

**Q15 Temp Output Threshold**

Temperature threshold above or below which Q15 output activates.

**3.3.12 Temperature Control: Setting Loss of Cooling Operation**

Loss of cooling is defined as a state where the Liebert® unit can no longer support cooling operation. During a loss of cooling situation, airflow output is still provided. This feature is supported on direct expansion (DX), chilled water (CW), and free cooling (FC) applications. The following scenarios represent the operational situations where a given unit may experience a loss of cooling:

1. Unit is OFF (excluding Standby operation, see A105.1 'Loss of cooling - Fan Operation')
2. Unit is ON but in Manual Mode
3. For Direct Expansion (DX) unit when one or more of the following are considered true:
  - a. DX unit is ON with Free Cooling unavailable and all refrigerant circuits are either:
    - Low Pressure Phase 9 (LP w/ 90 min delay)
    - Low Pressure Phase 6 (freeze protection 10 minute delay)
  - b. DX unit is ON with Free Cooling unavailable and compressors unavailable due to:
    - Pump down failure
    - High pressure lockout
    - High discharge
    - GC remote shutdown
    - Compressor overload
    - Various EEV alarm(s) preventing EEV operation
    - Unit is ON, all cooling operations are unavailable due to customer alarm input (Comp Lockout, FC Lockout, Flow AL LC, etc).
  - c. Free Cooling unavailable due to one of the following reasons:
    - Unit not within mixed mode/pump mode
    - Free Cooling status is continuously off for 130 seconds with a call for cooling because
      - U305.2 'FC Status' is not "ON".
      - Current call for cooling is less than 1%.

4. For Chilled Water unit when ALL of the following are considered to be true:
  - a. The unit has been powered ON for a least 30 min AND
  - b. Call for cooling is greater than A105.5 'Loss of Cooling - CW Threshold' (default 50%) AND
  - c. Temperature difference between Return Temp - Supply Temp is less than A105.2 'Loss of Cooling - Delta RET - Sup' (default 0.55k) AND
  - d. One or more of the following are true:
    - Unit return temperature is above S203 'Std. Sensor High Return Temperature'.
    - The above conditions a. - d.) are continuously true for A105.3 'Loss of Cooling - CW Delay' (default 1800 seconds).

When the unit is in this state, the end-user may define the desired unit operation.

## 3.4 Vertiv™ Liebert® Fluid Economizer

Two types of fluid economizers are offered, GLYCOOL and Dual-Cool. GLYCOOL models are two-pipe systems. This means that two pipes enter the unit and feed the chilled water/free-cooling coil as well as the compressor(s) and heat exchanger (eg., Liebert® Paradenser, tube-in-tube condenser or brazed plate heat exchanger). Dual Cool units can be either two pipe or four pipe systems. A two-pipe unit has two fluid lines dedicated to the secondary cooling source, and the compressor(s) heat rejection is an air cooled condenser. Four pipe Dual Cool models have two fluid pipes dedicated to chilled water/freecooling and two pipes for the compressor(s) heat exchanger. Each model offers a primary DX source and a secondary chilled water or free-cooling coil.

### 3.4.1 Differential Temperatures/Controls (Comparator Circuit)

#### Delta T (Temperature Difference) between Room and Fluid

The comparator circuit determines if the glycol / chilled water temperature of the second cooling source is low enough to provide at least partial cooling capacity. Free-Cooling Fluid Temperature is controlled in the User - Sensor Data menu, Figure 7.10 on page 128. The comparator circuit has four settings (DT Between Room / FC Type, [Service Menu, Setpoints]):

- **Disabled**
- **Contact**
- **Temp**
- **Set**

The **Disabled** setting is for standard compressorized and chilled water units that do not have a second cooling source. The Disabled setting can also be used to disable the second source of cooling. The Contact setting is used when an external input is being used to determine when the second cooling source is to be activated. The external control communicates to the Liebert unit via contact closure.

- Closed = activate second cooling source control
- Open = deactivate second cooling source control

The **Temp** setting is the factory default (12°F [-11.1°C]) on free-cooling and dual cooling units. If the temperature difference between the second source cooling fluid parameter, Free-cooling Fluid Temperature (User Menu, Sensor Data) and room air is equal to or greater than the adjustable DT Between Room / FC Fluid (Service Menu, Setpoints) value, then the second source cooling fluid will be used to provide at least partial cooling.

The **Set** option allows free-cooling whenever the fluid temperature sensed (User Menu > Sensor Data) is colder than the temperature setpoint. The difference required between the temperature setpoint and the fluid temperature is adjusted on the following line DT2 Room / FC Fluid value (Service Menu, Setpoints). The second source cooling fluid will be used to provide cooling if the temperature difference between the second source cooling fluid parameter, Free-cooling Fluid Temperature and room air is equal to or greater than the adjustable DT Between Room / FC Fluid value.

Sensors used for this delta T are: room/local sensor or the return air sensor; and the glycol sensor.

If this delta T is true, the Free-cooling Status indication will show “On” instead of “Off”. **The status is found in the User- Sensor Data menu, Figure 7.10 on page 28.** The primary and secondary source of cooling will stage accordingly. See the next sections for more information.

**Figure 3.17 Second Cooling Source and Two-Step Compressorized Cooling**

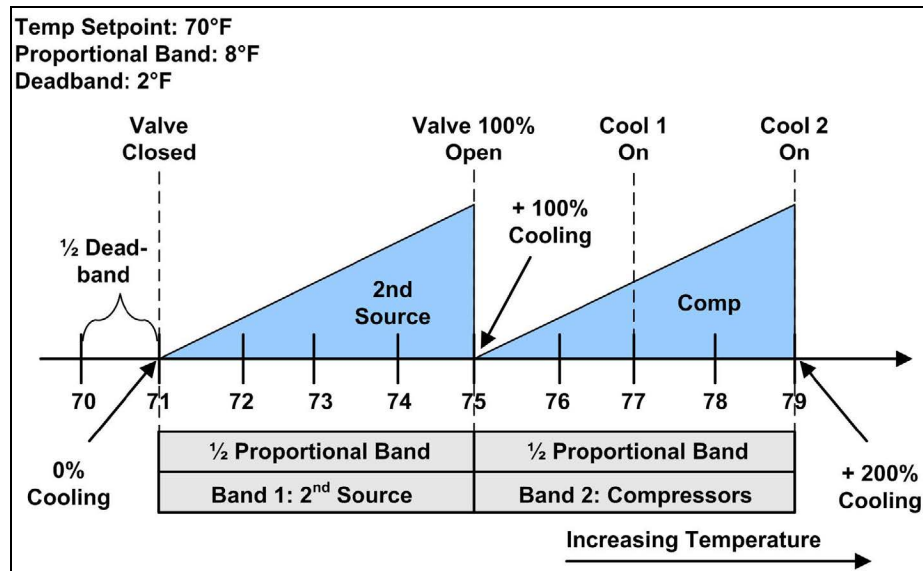

**Minimum Chilled Water Temperature**—This feature allows the user to select a minimum chilled water temperature to prevent simultaneous operation of the chilled water (free cooling) and compressor(s) on units factory-programmed to operate both sources simultaneously. This feature is enabled in Service>Setpoints, parameter Minimum CW Temp.

If the fluid temperature sensed is below the Minimum CW Temp Value, (Service Menu, Setpoints), and the Delta T (Temperature Difference) Between Room and Glycol (see [Differential Temperatures/Controls \(Comparator Circuit\)](#) on the previous page ) is satisfied, the control will operate ONLY the chilled water for cooling. The compressor(s) is locked out. If cooling does not operate, (i.e., loss of chilled water flow), the control will override this setting and activate a compressor(s). When this happens, free-cooling will be locked out for one hour.

If the fluid temperature is above the minimum CW value, the control will operate the chilled water (free cooling) and compressor(s) simultaneously if needed. If the Minimum CW Temp is disabled, the control may operate both sources as load requires.

## GLYCOOL Cooling—Freecooling

GLYCOOL units may be programmed to stage cooling components in either of two ways:

- Operate freecooling or compressor(s) to maintain temperature (factory default)
- Operate freecooling and compressor(s) simultaneously

Caution must be taken when operating free-cooling and the compressor simultaneously on GLYCOOL units. Adequate flow must be provided to the unit to prevent high pressure when 100% free-cooling is required in addition to DX cooling. Running too cold of fluid temperature and compressor(s) simultaneously may cause refrigerant pressure to drop. Contact technical support at 800-543-2778 for more information on simultaneous operation setup.

When the unit is configured to operate free-cooling or compressors(s), free-cooling eligibility is based on the comparator circuit discussed in [Differential Temperatures/Controls \(Comparator Circuit\)](#) on page 70 . If the circuit determines free-cooling will condition the space, the valve will open and close as temperature deviates from the setpoint. If the comparator circuit determines that free-cooling is not capable of conditioning the space, control is automatically replaced by compressor (s).

During either freecooling or compressor operation, the control uses the temperature proportional band to determine which operation to perform (cooling/heating) and how much capacity to provide. The Temperature Proportional Band is a user-defined range that is divided into two equal parts for cooling and heating. The Temperature Setpoint is between these two equal parts. An optional temperature and heating deadband range can be defined, which is equally divided on either side of the setpoint and separates the two halves of the proportional band.

When the unit is configured to operate free-cooling and compressor(s) simultaneously, the comparator circuit determines free-cooling eligibility. Free-cooling and compressor(s) are staged based on temperature deviation from setpoint. The cooling proportional band is divided into two parts for simultaneous operation, the first portion is used for free-cooling and the second for DX operation. [Second Cooling Source and Two-Step Compressorized Cooling](#) on the previous page on the previous page illustrates how the cooling proportional band is broken out on a freecooling unit with two step compressors.

During either free-cooling or compressor operation, the control uses the temperature proportional band to determine which operation to perform (cooling/heating) and how much capacity to provide. The Temperature Proportional Band is a user-defined range that is divided into two equal parts for cooling and heating. The Temperature Setpoint is between these two equal parts. An optional temperature and heating deadband range can be defined, which is equally divided on either side of the setpoint and separates the two halves of the proportional band.

When the unit is configured to operate freecooling and compressor(s) simultaneously, the comparator circuit determines free-cooling eligibility. Free-cooling and compressor(s) are staged based on temperature deviation from setpoint. The cooling proportional band is divided into two parts for simultaneous operation, the first portion is used for free-cooling and the second for DX operation. [Second Cooling Source and Two-Step Compressorized Cooling](#) on the previous page on the previous page illustrates how the cooling proportional band is broken out on a free-cooling unit with two step compressors.

Cooling Control Band for Simultaneous Operation = (Temperature Proportional Band/2) / 2 + (Temperature Deadband/2)

If the comparator circuit determines that freecooling is ineligible for use, the compressor band will shift to the left.

Figure 3.18 Freecooling and Compressorized Operation

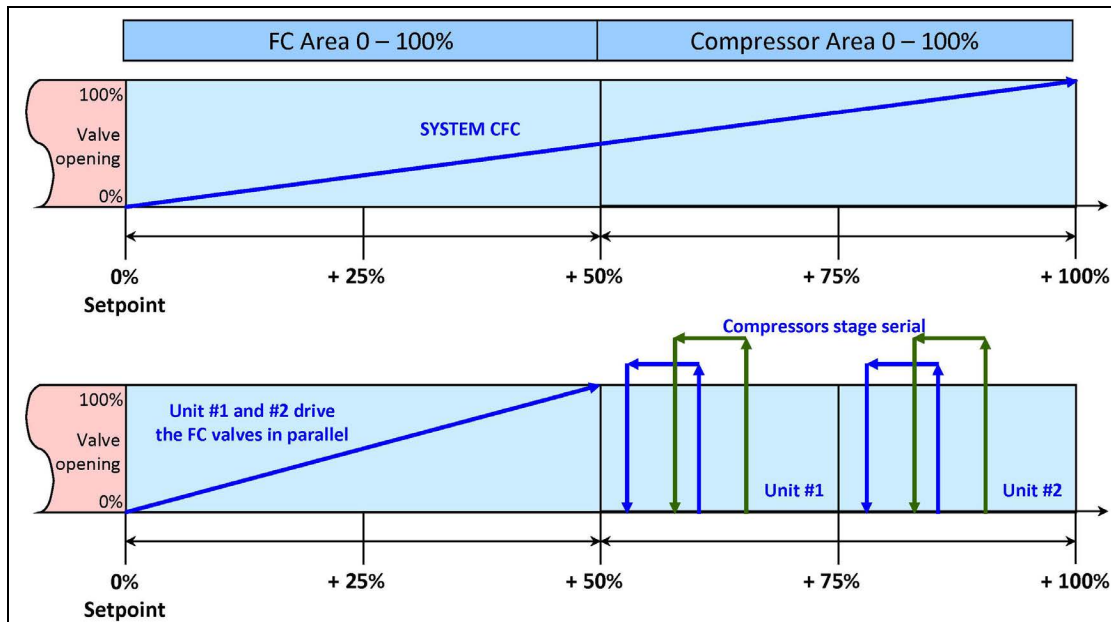

### 3.4.2 Vertiv™ Liebert® Air Economizer

The Liebert® Air Economizer is an option for Liebert downflow units. The Liebert Air Economizer uses cool outdoor air in mild climates to condition indoor spaces. It is functional only on cooling units with a Liebert® iCOM™ that has been wired and configured to accommodate the Liebert Air Economizer.

The Liebert® Air Economizer ships with sensors to determine the temperature and humidity of return air and outdoor air. The sensors and wiring to connect them are shipped inside the Liebert® Air Economizer:

- Outdoor air sensor
- Return air sensor
- Supply air thermistor

These must be installed and connected to the primary cooling unit. The outdoor air sensor and return air sensor connections for the Liebert® DS and Liebert® CW are shown in Figure 3.17 on the next page. Connect the supply air thermistor as shown in **Figure 3.19** on the next page (it must be routed from the cooling unit and secured). The illustration shows connections for the Liebert® DS and Liebert® CW.

Figure 3.19 Temperature and Humidity Sensor Connections—Vertiv™ Liebert® DS and Vertiv™ Liebert® CW

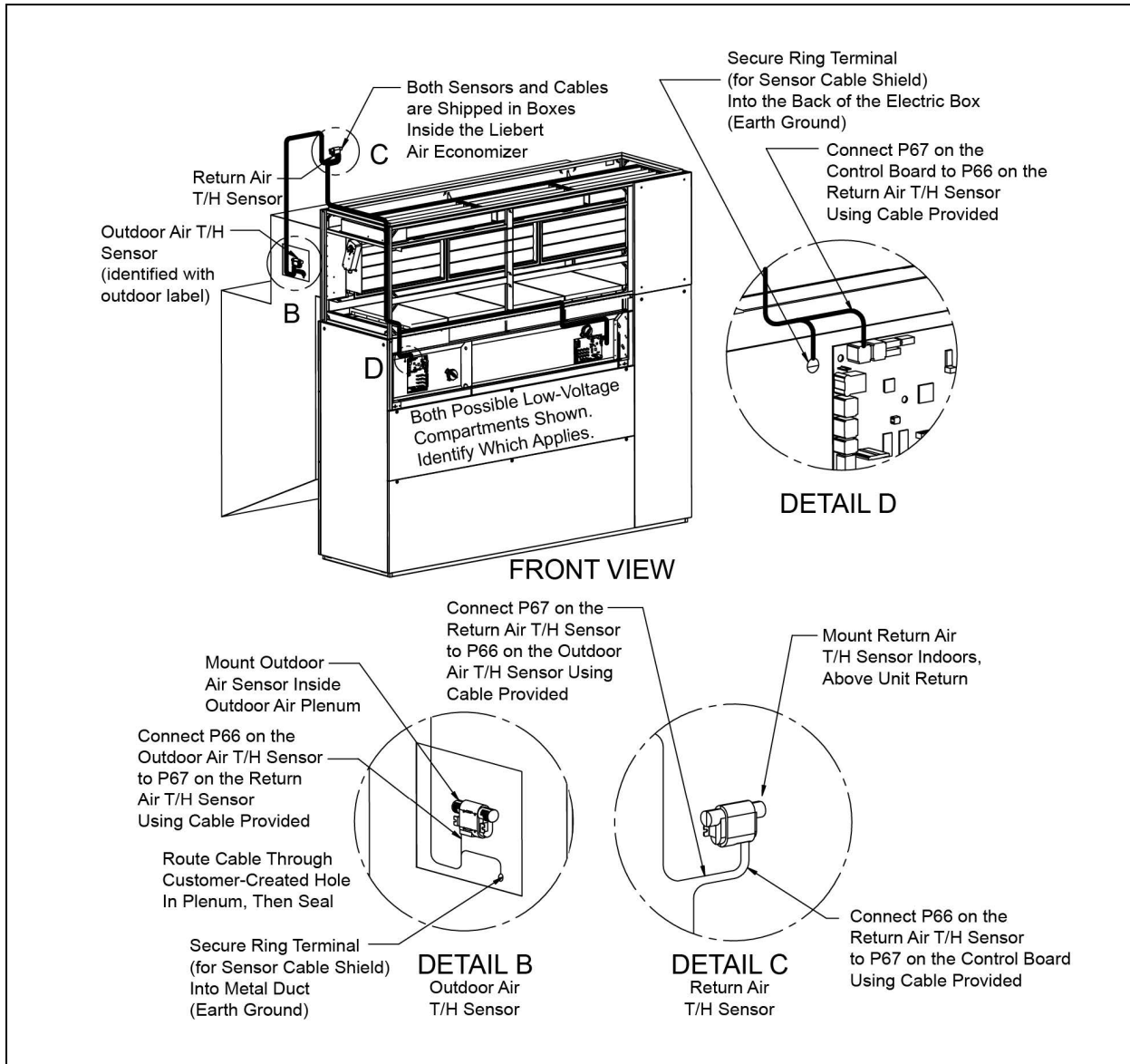
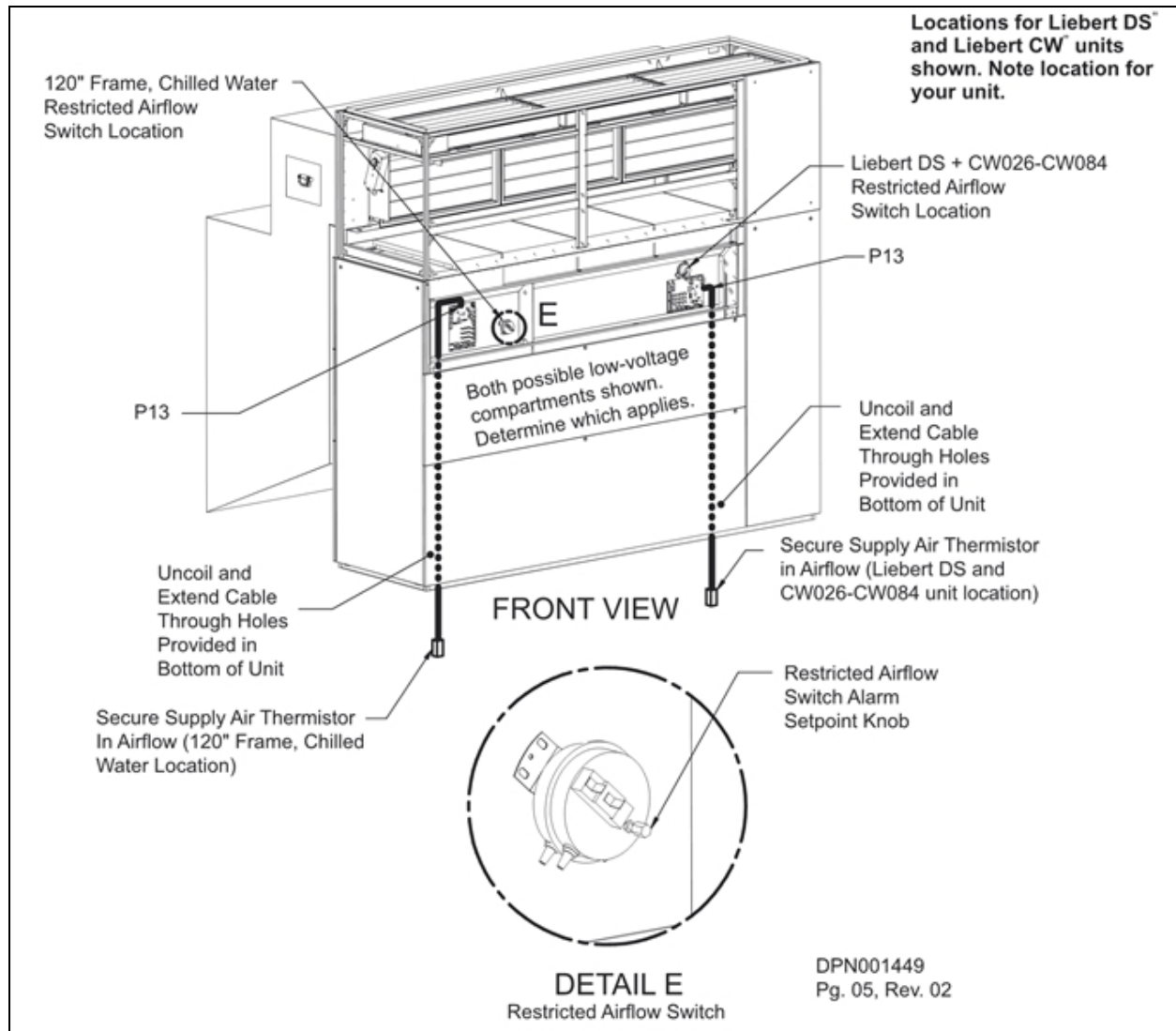

Figure 3.20 Supply Limit Thermistor Wiring and Restricted Airflow Switch Location



### 3.5 Vertiv™ Liebert® Air Economizer Operation

Liebert® cooling units control the Liebert Air Economizer with the analog outputs of the Vertiv™ Liebert® iCOM™ control. The Liebert® iCOM™ can be used with a Liebert® Air Economizer or with an air economizer supplied by others if equipped with 0-10VDC or 2-10VDC dampers. The Liebert® iCOM™ is capable of driving two independent damper motors or can be set up through the software to output a single signal where the dampers are inversely driven.

The primary cooling unit responds to sensors that monitor the temperature and humidity of the outdoor air, return air and supply air. If outdoor conditions are within the tolerances set, the primary cooling unit opens the Liebert® Air Economizer's dampers varying amounts to use outdoor air for cooling. When outdoor conditions are too warm or humid for cooling, the primary cooling unit closes the Liebert® Air Economizer's dampers, taking it out of the cooling process. Humidification and dehumidification are disabled when the Liebert® Air Economizer is operating.

**NOTICE**

Risk of high or low humidity. Can cause environmental conditions that are outside equipment requirements.

While the Liebert® Air Economizer is operating, the primary cooling unit's humidification and dehumidification are inhibited. If humidity level is important to operational requirements, it must be controlled by other methods during operation of the Liebert® Air Economizer. While the primary cooling unit is cooling without the Liebert® Air Economizer, the primary cooling unit will control humidity levels according to its setpoints.

**NOTICE**

Risk of freezing temperatures. Can cause equipment and property damage.

Low outdoor temperatures can produce freezing conditions that adversely affect cooling systems employing water, particularly when the water is not moving through the pipes. When cooling system water is not moving, frozen waterlines, burst coils and water damage are possible. The outside damper must be set so that it is fully closed when freezing temperatures are possible and the cooling system is not operating. See [Disable the Vertiv™ Liebert® Air Economizer](#) on page 79 This can be achieved by either connecting a freeze stat that interrupts the economizer signal or by wiring a freeze stat directly into the Liebert® iCOM™'s customer input.

The risk of freezing is increased unless the proper amount of glycol is added to the chilled water unit loops.

**NOTICE**

Risk of infiltration of odors, smoke and particulates from outside air. Can cause environmental conditions that are outside equipment requirements.

The Liebert® Air Economizer does not remove odors, smoke, gases or particulates from the outside air used for cooling. These must be controlled by other methods.

When the Liebert® Air Economizer is being used for cooling, both the outside air damper and the room return air damper are active in an opposing relationship. The cooling requirement and temperature of the outdoor air will determine the position of the outside air damper. It will range from fully closed to fully open. As the outside air damper moves toward fully open, the return air damper will close to a minimum of 15%. The 15% minimum is to make sure that air remains circulating near the return air sensor. If the return air sensor is moved to another position where there is constant circulation of air in both outdoor and indoor modes, then the minimum 15% indoor damper position can be removed.

**NOTICE**

Risk of improper operation. Can cause degraded cooling and ventilation operation because of improper building air pressure.

The incoming air from the outside damper requires expelling an equal volume of air through a field-provided powered relief air vent. The volume that must be expelled will vary from 0 to 80% of the total airflow for all Liebert® Air Economizer units. The powered relief system should be sized for 80% of the total airflow for all Liebert® Air Economizer units in the conditioned space and to maintain minimal building air pressure.

**3.5.1 Liebert® Air Economizer System Overview**

The objective of the Liebert® Air Economizer is to expel warm air from the conditioned space and bring in cooler air through the Liebert® Air Economizer. This function is monitored continuously by the Liebert® iCOM™

**Figure 3.21** on the facing page below shows an example of the air flow pattern of a Liebert® Air Economizer system. The indoor sensor must be positioned where there is airflow when the system is in full economizer operation and when the system is operating in non-economizer mode.

If the indoor damper position has been changed to 0% from the factory default of 15%, then the indoor sensor must be moved, preferably to the hot aisle.



Figure 3.21 Air Flow Pattern of a Liebert® Air Economizer System—Regular Ceiling

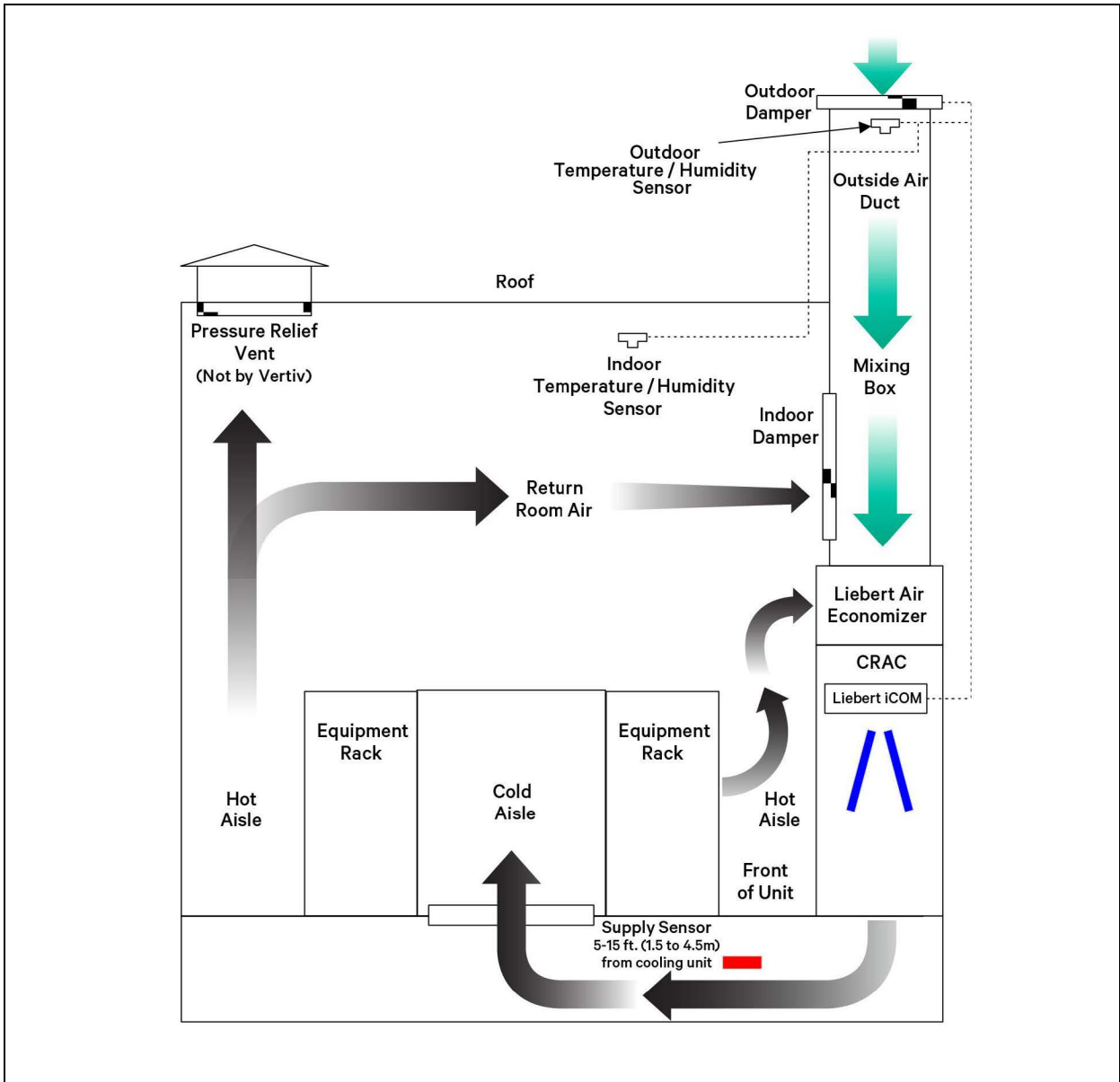
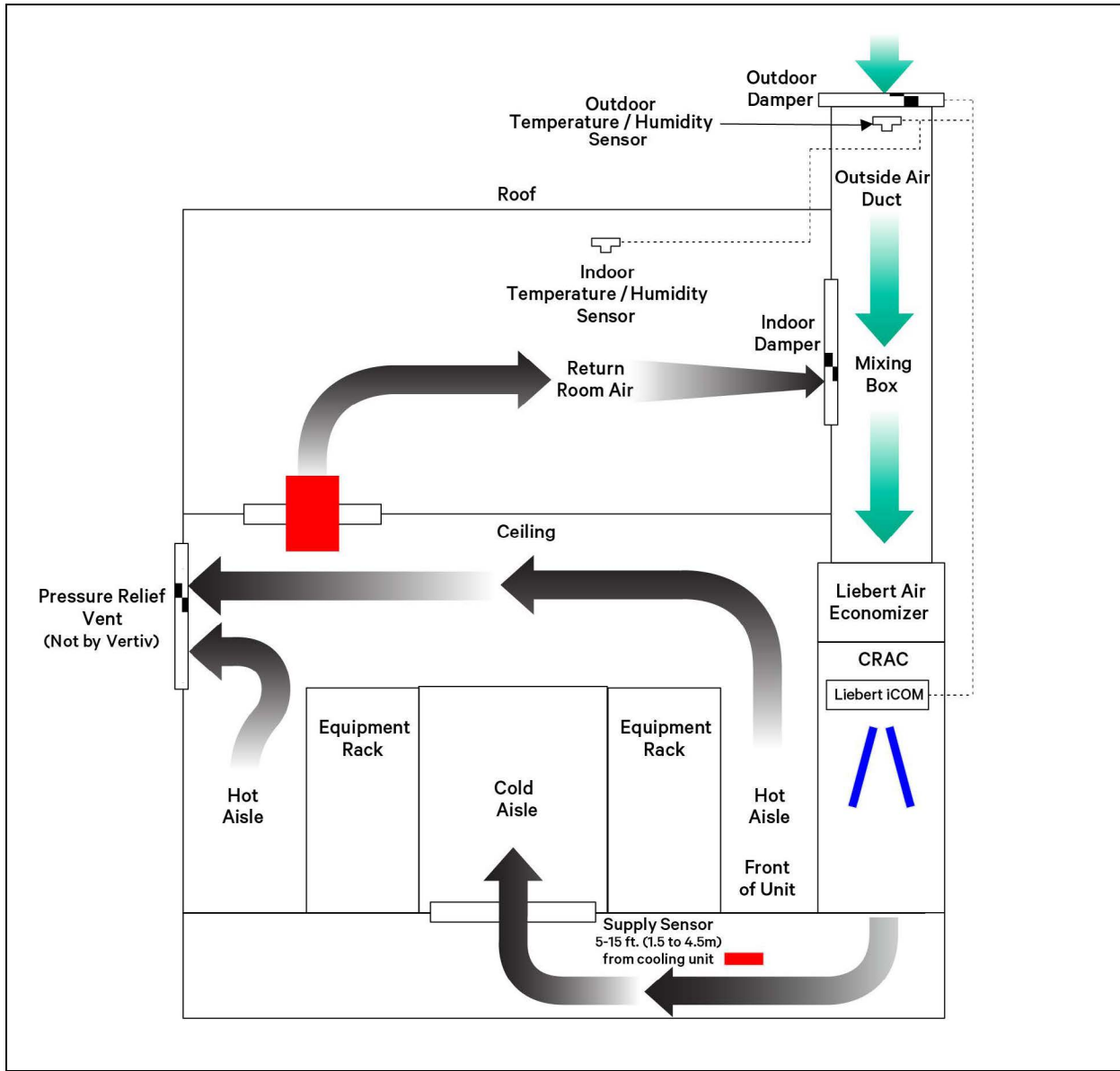

Figure 3.22 Air Flow Pattern of a Liebert® Air Economizer System-Dropped Ceiling



**Not in Operation**

When the Liebert® Air Economizer is not operating, the outside air damper is closed, the return air damper is open and the relief air vent fan is shut down. This permits air from the conditioned space to be drawn into the primary cooling unit, cooled and expelled into the conditioned space. The relief air vent is not required while the Liebert® Air Economizer is not in service because no air volume is being brought into the conditioned space.

**Startup Configurations**

When a non-Liebert mixing box and damper motors are used, make sure that the following configurations are verified before a unit is placed into service.

- Verify that spring closed return dampers are installed and operating properly. Without a spring return motor, the dampers will remain in the position they were in when power was present.

- While the Liebert® Air Economizer is not operating, which could be due to the outdoor air conditions, a manual lockout through the Liebert® iCOM™ or a Unit Off state will result in 2VDC (3.5VDC on 2-10V actuators) being present on the associated indoor and outdoor analog outputs. The 2VDC (3.5VDC on 2-10V actuators) signal must result in the outdoor damper being closed and return damper opened.
- During full Liebert® Air Economizer operation, the Liebert® iCOM™ will send 10VDC to the return and outdoor damper that must open the outdoor damper and close the return damper to its minimum position of 15%.

#### NOTICE

Risk of improper operation. Could cause frozen coils, resulting in degraded operation, water leaks, equipment damage and building damage.

Failure to verify that the indoor and outdoor damper operation is correct could freeze the chilled water coils, cause condensation within the data center or overload the main fan.

### 3.5.2 Disable the Vertiv™ Liebert® Air Economizer

The Liebert® Air Economizer can be disabled using a hard-wired deactivation switch, through the Vertiv™ Liebert® iCOM™ display, or through a remote monitoring system using a Vertiv™ Liebert® IntelliSlot™ card.

A field-installed and wired normally closed deactivation switch may be connected to Terminals 24 and 51 in place of the factory-supplied jumper. Removing a factory-installed jumper will deactivate the unit's air economizer function (see **Figure 3.23** below) and produces an FC Lockout warning. A normally open deactivation switch may also be used. Line S227 of the Service Menu > Set Alarms must be changed from Opened to Closed.

The Liebert® Air Economizer may be disabled by changing SA02 Enable Economizer to No.

The Liebert® Air Economizer may be disabled through a remote monitoring system by writing a disable command to data label Air Economizer Control. When disabled, SA02 status will read No. The building management system may override SA04 through SA07 by writing an enable command. When the enable command is written, SA02 will read Remote. Refer to the Liebert® IntelliSlot™ Modbus 485, Modbus IP and BACnet IP Reference Guide, SL-28170, for additional information. The manual is available at [www.Vertiv.com](http://www.Vertiv.com). Deactivating the Liebert® Air Economizer will transfer all cooling to the secondary source.

#### Air Economizer Remote Status Indication

The K11 relay can be activated when the Liebert® iCOM™ determines that the conditions are acceptable for the Liebert® Air Economizer to operate. This relay will remain active during a BMS remote deactivation of the Liebert® Air Economizer.

**Figure 3.23 Deactivation Switch**

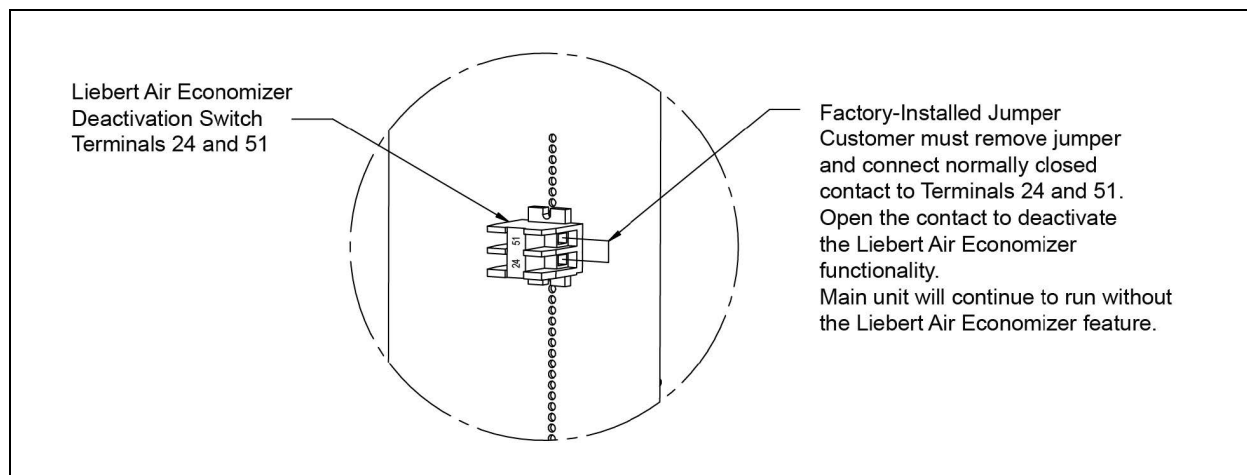

## Air Economizer Emergency Override

The Liebert® Air Economizer can be configured to override SA04 through SA07 in the event the facility gets too hot. This override becomes active if the room temperature exceeds an adjustable high temperature high return temperature threshold set on line SA10. The emergency override will open the outdoor air damper and close the indoor air damper. The override function can be delayed after a fan start on line SA11, allowing airflow to pass over the room sensor to get an accurate reading before any emergency modes are activated. When the economizer is operating in emergency mode, an Eco Emergency Override event will be triggered.

### 3.5.3 Adjust the Restricted Airflow Switch on the Vertiv™ Liebert® Air Economizer

The restricted airflow switch inside the cooling unit must be adjusted for the Liebert® Air Economizer to operate properly and efficiently. To adjust the switch:

1. Inspect all connections, restore power to operate the unit's blower.
2. Go to the Service Menus, Diagnostic / Service Mode.
3. Enter the Service Menu password 5010.
4. Enable manual mode on line S313. The unit will shut Off.
5. Go to line S314 Motors and change the value displayed from No to Yes. This will allow the evaporator fan to run with the outside air damper at minimum position.
6. Confirm the fan is running at minimum speed. This is shown on line S343 "Analog Out 3" of the Diagnostics / Service Mode.
7. Confirm the outside air damper has moved to the minimum position by visually checking damper position.
8. Find the restricted airflow switch in the cooling unit (Figure 3.18 on page 45 shows the switch location in both the Liebert® CW and Liebert® DS).
9. Turn the restricted airflow switch alarm setpoint knob clockwise until it trips. The cooling unit will also alarm.
  - a. Place a voltmeter on Terminal 56 and on the chassis ground.
  - b. Turn the airflow sensor counterclockwise until the voltmeter indicates 0VAC.
  - c. Turn the airflow sensor adjustment screw clockwise until the voltmeter indicates 24VAC.
  - d. When the voltmeter shows 24VAC, turn the screw counterclockwise one full turn.

Once the airflow switch has been calibrated, go to the Service Menus, Diagnostics / Service Mode. Using the Service Menu password 5010, disable manual mode on line S313.

Cycle power Off to the unit using the I/O button, then turn the unit Off at the disconnect. Cycle power back On to the disconnect, then press the I/O button once the control has finished booting up. Verify unit operation as the fan starts and outside damper opens. If a 'Reduced Eco Airflow' alarm occurs during when the unit starts, the alarm time delay located in Service, Set Alarms may need to be adjusted higher. The reduced airflow alarm is latched in the control for 90 minutes after calibration. Acknowledge this alarm and allow it to clear by pressing the horn button on the control once. The alarm may also be cleared by shutting Off power to the Vertiv™ Liebert® iCOM™ and cycling power to the cooling unit. The unit will now resume normal operation.

## 4 Managing Events: Alarms, Warnings and Messages

Events are notifications of operating status for the cooling unit, its components, and auxiliary devices. All events are recorded in the Event Log, and alarm and warning events are also displayed on the Alarms panel (See [Viewing the Event Log](#) on page 20 , and [Viewing Unit Alarms](#) on page 17 .)

In some cases, depending on configuration, an alarm event may power off the cooling unit, but not always. However, if a standby unit is configured, all alarm events stop the faulty unit and start the standby unit. Message and warning events do not.

### 4.1 Event Properties

The ALARMS & EVENTS panel lists all events available on the system. You can view and modify events and the criteria that trigger visual/audible alarms including:

- Critical thresholds
- Time delays
- Enable/disable
- Event type
- Adding custom events

**NOTE:** Not all event properties may be adjusted, depending on the criticality of the event, which is factory set.

To open the panel:

Touch  , then  > *Alarm/Event Setup*.

**NOTE:** Depending on the type of thermal management unit, included components, and control settings of your system, all of the options listed may not be available on your Vertiv™ Liebert® iCOM™ display.

#### 4.1.1 Alarms and Events Panel Fields

##### Property

Lists groups of events, expanding displays the events in each group. See [Enabling Events and Editing Event Settings](#) on the next page .

##### Type

Event type. See [Selecting Event Type and Setting Alarm/Warning Notification](#) on page 83 .

## Ack

Indicates type of acknowledgment required. See [Acknowledging Alarms](#) on page 18 . This option is not available with all alarm types.

- Auto: The alarm is acknowledged automatically. It goes away if the situation that triggered alarm event is no longer true.
- Manual: The alarm goes away only when acknowledged, even if the situation that triggered the alarm event is resolved/no longer true.



## Reset

Indicates type of reset required for the event. This option is not available with all alarm types:

- Auto: The alarm resets automatically after acknowledgment.
- Manual: The alarm must be reset manually after acknowledgment. See [Acknowledging Alarms](#) on page 18 .

## 4.2 Enabling Events and Editing Event Settings

In the ALARMS & EVENTS panel, events are grouped into categories for easier management, for example, the factory set remote sensor alarms and humidification/dehumidification events. In some cases, touch the group heading provides edit options for the entire group, like thresholds, delays and enable/disable. Each event includes settings specific for that event and the notification option where event type and alarm notifications are selected (See [Selecting Event Type and Setting Alarm/Warning Notification](#) on the facing page ).

1. Touch , then  > *Alarm/Event Setup*. The ALARMS & EVENTS panel opens.
2. Scroll or search to find the event, touch the set's heading to display the properties and values for the entire set in the EDIT panel.  
– or –  
Touch an individual alarm or event to display it's specific values in the EDIT panel.

**NOTE:** To edit the event type and notification, see [Selecting Event Type and Setting Alarm/Warning Notification](#) on the facing page .

3. Use the EDIT panel to adjust the settings for the selected event or group of events.



## 4.3 Selecting Event Type and Setting Alarm/Warning Notification

Setting notification delays and disabling visual notification prevents nuisance notifications. Customize to notify of critical events on your cooling system.

**NOTE: If the event includes a safety function, such as high pressure, low pressure, main fan overload, etc., the safety function executes regardless of event type or notification setting. However, notification timing delays still apply.**

**Table 4.2** on page 87, lists the default and adjustable notification settings for events. **Table 4.3** on page 88, describes events for the Vertiv™ Liebert® MC Condenser. **Table 4.4** on page 90, describes events for the Vertiv™ Liebert® EconoPhase unit. **Table 4.5** on page 91, describes events for the Vertiv™ Liebert® DSE compressors. **Table 4.6** on page 91, describes events for the EEV alarm board.

To select event type and notification:

1. Touch , then  > *Alarm/Event Setup*.
2. Scroll or search to find the event and touch the alarm or event.
3. On the EDIT panel, touch *Notifications*. The EDIT panel displays the notification properties.
4. Adjust the notification properties described in the [Notification Properties](#) below, then touch *Save*. The notification is updated.
  - Touch *Cancel* to discard the changes without saving.

### 4.3.1 Notification Properties

#### Delay

Time, in seconds, to delay notification after event trigger. Depending on the event, the delay may or may not be adjusted. **Table 4.2** on page 87, lists the delays and their default settings.

- If the notification delay for the event is greater than the delay set for the event group, the group's delay includes the event's delay.

## Enable

Enables/disables notification. Touch the switch to set On or Off.

- When disabled, events are not logged or displayed and visual/audible alarm notifications are not made.

## Type

Logging and notification level of the event. **Table 4.1** below, describes the event type and notification it generates. **Table 4.2** on page 87, lists the default types for events.

**Table 4.1 Notification Types**

Type	Description
Message	Stored in event log only. No visual or audible notification.
Warning	Listed with a yellow status dot on the ALARMS panel and the LED flashes. See <b>Table 11.1</b> on page 165, and <a href="#">Viewing Unit Alarms</a> on page 17.
Alarm	Listed with a red status dot on the ALARMS panel, the LED flashes, and the audible alarm sounds. See <b>Table 11.1</b> on page 165, <a href="#">Viewing Unit Alarms</a> on page 17, and <a href="#">Enabling the Audible Alarm Notification</a> on page 92.

**Table 4.2** on page 87, lists the default settings for each event.

- Internal delay is factory set and not adjustable. It is the time delay after event trigger that notification is sent.
- Default delay may or may not be adjustable and is added to the internal delay of event notification.
- Type may be adjustable or may be fixed.



**NOTE: Depending on customization, some events may not be available on your cooling unit.**

**Table 4.2 Event Notification Defaults**

Event	Internal delay	Default delay/Range for adjustment	Type
MAIN FAN OVERLOAD	2 sec	5 sec/0 – 9999 *	ALM
LOSS OF AIRFLOW	3 sec	3 sec/0 – 9999 *	ALM
CLOGGED FILTERS	2 sec	2 sec/0 – 9999 *	WRN
HIGH ROOM TEMP	1 min. after fan on	30 sec/0 – 9999	Fixed to WRN
LOW ROOM TEMP	1 min. after fan on	30 sec/0 – 9999	Fixed to WRN
HIGH ROOM HUM	1 min. after fan on	30 sec/0 – 9999	Fixed to WRN
LOW ROOM HUM	1 min. after fan on	30 sec/0 – 9999	Fixed to WRN
HIGH TEMP SENSOR A	1 min. after fan on	30 sec/0 – 9999	Fixed to WRN
LOW TEMP SENSOR A	1 min. after fan on	30 sec/0 – 9999	Fixed to WRN
HIGH HUM SENSOR A	1 min. after fan on	30 sec/0 – 9999	Fixed to WRN
LOW HUM SENSOR A	1 min. after fan on	30 sec/0 – 9999	Fixed to WRN
COMP 1 OVERLOAD	Internal Calc.	no	ALM
COMP 2 OVERLOAD	Internal Calc.	no	ALM
COMP 1 HIGH PRESSURE	Internal Calc.	no	ALM
COMP 2 HIGH PRESSURE	Internal Calc.	no	ALM
COMP 1 LOW PRESSURE	Internal Calc.	no	ALM
COMP 2 LOW PRESSURE	Internal Calc.	no	ALM
COMP 1 PUMPDOWN FAIL	Internal Calc.	no	ALM
COMP 2 PUMPDOWN FAIL	Internal Calc.	no	ALM
DIG SCROLL1 HIGH TEMP	Internal Calc.	no	ALM
DIG SCROLL2 HIGH TEMP	Internal Calc.	no	ALM
EL HEAT HIGH TEMP	5 sec	0 sec/0 – 9999	WRN
WORKING HRS EXCEEDED	0 sec	0 sec/0 – 9999	Fixed to WRN
SMOKE DETECTED	2 sec	2 sec/0 – 9999 *	ALM
WATER UNDER FLOOR	2 sec	2 sec/0 – 9999 *	ALM
COND PUMP-HIGH WATER	2 sec	2 sec/0 – 9999 *	ALM
LOSS OF FLOW	5 sec Reset delay: 10 sec	2 sec/0 – 9999 *	ALM
STBY GLYCOL PUMP ON	2 sec	2 sec/0 – 9999 *	ALM
STANDBY UNIT ON	2 sec	2 sec/0 – 9999 *	ALM
HUMIDIFIER PROBLEM	2 sec	2 sec/0 – 9999 *	ALM
NO CONNECTION w/Unit1	Internal Calc.	-	WRN

**Table 4.2 Event Notification Defaults (continued)**

Event	Internal delay	Default delay/Range for adjustment	Type
UNIT X DISCONNECTED	Internal Calc.	-	WRN
LOSS OF POWER	0 sec	no	ALM
CUSTOMER INPUT 1	2 sec	2 sec/0 – 9999 *	ALM
CUSTOMER INPUT 2	2 sec	2 sec/0 – 9999 *	ALM
CUSTOMER INPUT 3	2 sec	2 sec/0 – 9999 *	ALM
CUSTOMER INPUT 4	2 sec	2 sec/0 – 9999 *	ALM
CALL SERVICE	2 sec	2 sec/0 – 9999 *	MSG
HIGH TEMPERATURE	2 sec	2 sec/0 – 9999 *	MSG
LOSS OF AIR BLOWER 1	2 sec	2 sec/0 – 9999 *	ALM
REHEAT LOCKOUT	2 sec	2 sec/0 – 9999 *	WRN
HUMIDIFIER LOCKOUT	2 sec	2 sec/0 – 9999 *	WRN
FC LOCKOUT	2 sec	2 sec/0 – 9999 *	WRN
COMPRESSOR(S) LOCKOUT	2 sec	2 sec/0 – 9999 *	WRN
COMP 1 SHORT CYCLE	0 sec	0 – 9999	MSG
COMP 2 SHORT CYCLE	0 sec	0 – 9999	MSG
No Power	0 sec	0 sec/0 – 9999WRN	
Condensate 1 Failure	0 sec	5 sec/0 – 9999	WRN
Condensate 2 Failure	0 sec	5 sec/0 – 9999	WRN
EC Fan Fault	0 sec	10 sec/0 – 9999	ALM
HIGH SUP TEMP	0 sec	30 sec/0 – 9999	WRN
LOW SUP TEMP	0 sec	30 sec/0 – 9999	ALM
REDUCED ECO AIRFLOW	0 sec	3 sec/0 – 9999	WRN
ECO HI TEMP OVERRIDE	0 sec	10 sec/0 – 9999	WRN
TEMP CTRL SENSOR FAIL	0 sec	3 sec/0 – 99999	ALM
HIGH DEW POINT	0 sec	30 sec/0 – 9999	WRN
LOW DEW POINT	0 sec	30 sec/0 – 9999	WRN
HI DEW POINT SENSOR A	0 sec	30 sec/0 – 9999	WRN
LOW DEW POINT SENSOR A	0 sec	30 sec/0 – 9999	WRN
HIGH REMOTE SENSOR	0 sec	30 sec/0 – 9999	WRN
POWER "A" FAILURE	0 sec	10 sec/0 – 9999	ALM
POWER "B" FAILURE	0 sec	10 sec/0 – 9999	ALM
AIRFLOW SENSOR FAILURE	0 sec	10 sec/0 – 9999	WRN
HUM CTRL SENSOR FAIL	0 sec	30 sec/0 – 9999	WRN
LOSS OF FLOW	0 sec	5 sec/0 – 9999	ALM

**Table 4.2 Event Notification Defaults (continued)**

Event	Internal delay	Default delay/Range for adjustment	Type
STAT PRES SENSOR FAIL	0 sec	120 sec/0 – 9999	ALM
LOW STATIC PRESSURE	0 sec	120 sec/0 – 9999	WRN
HIGH STATIC PRESSURE	0 sec	120 sec/0 – 9999	WRN
STATPRES OUT OF RANGE	0 sec	150 sec/0 – 9999	WRN
DAMPER FAILURE	0 sec	10 sec/0 – 9999	ALM
BMS DISCONNECTED	0 sec	ENABLED/DIS - ENAB	WRN

**Table 4.3** on the next page, describes events available with a Vertiv™ Liebert® MC Condenser.

**NOTE: A CANbus connection between the Liebert® MC condenser and Vertiv™ Liebert® iCOM™ is required to trigger these events.**

**Table 4.3 Events Specific to Liebert® MC Condenser**

Event	Description
CAN GC 1 or 2	<ul style="list-style-type: none"> <li>The Liebert® iCOM™ board cannot establish communication with the Liebert® MC condenser board for 10 seconds consecutively.</li> <li>Alarm notification displayed for the corresponding circuit.</li> <li>Liebert® EconoPhase pump operation disabled for the circuit affected.</li> <li>When Liebert® iCOM™ re-establishes communication with the Liebert® MC board, the event is reset.</li> </ul>
GC 1 or 2 Rem Shutdown	<ul style="list-style-type: none"> <li>Remote shut down requested.</li> <li>Compressor(s) and Liebert® EconoPhase pump(s) in the corresponding circuit are powered-off.</li> <li>If event occurs on the lead circuit, then the lead-lag order of the compressors/tandem banks changes.</li> <li>When the Liebert® MC condenser remote-shutdown circuit returns to inactive state (closed), the event is reset and the compressors in that circuit may be powered-on.</li> <li>Normal compressor lead-lag sequence resumes when both compressors are Off.</li> </ul>
GC 1 or 2 Board Fail	An unrecoverable failure of the Liebert® MC condenser control board has occurred causing a condenser shutdown.
GC Pres Sens Fail C1 or C2	Condenser pressure sensor failure
GC High Cond Press C1 or C2	High condensing pressure
GC Low Cond Press C1 or C2	Low condensing pressure
GC 1 or 2 Amb Sens Fail	Ambient-temperature sensor failure
GC 1 or 2 Amb Temp Limit	High/low ambient temperature
GC Temp Sens Fail C1 or C2	Refrigerant liquid line temperature-sensor failure
GC High Cond Temp C1 or C2	High refrigerant liquid line temperature

**Table 4.3 Events Specific to Liebert® MC Condenser (continued)**

Event	Description
GC Low Cond Temp C1 or C2	Low refrigerant liquid line temperature
GC 1 or 2 Fan 1 through 4 FAIL	<p>The following events may result from a fan failure alarm. Refer to the specific fan manufacturer's literature for troubleshooting information.</p> <ul style="list-style-type: none"> <li>• VSD high link current</li> <li>• VSD drive error</li> <li>• VSD earth to ground fault</li> <li>• VSD electronics heat sink thermal overload</li> <li>• VSD hall failure</li> <li>• VSD IGBT failure</li> <li>• VSD line fault</li> <li>• VSD motor locked</li> <li>• VSD motor thermal overload</li> <li>• VSD phase failure</li> <li>• VSD-specific uncategorized alarm detected</li> <li>• VSD electronics high-temperature condition</li> <li>• VSD high link voltage</li> <li>• VSD low link voltage</li> <li>• RS-485 communications failure</li> </ul>
GC 1 or 2 TVSS Failure	TVSS alarm

**Table 4.4** on page 90, describes events available with a Liebert® EconoPhase.

**Table 4.4 Events Specific to Liebert® EconoPhase**

Event	Description
PB1 BOARD FAIL	<p>An unrecoverable failure of the pump control board has occurred. Pump shut down.</p> <ul style="list-style-type: none"> <li>• Pump board must be rebooted to reset event.</li> </ul>
PB1 CAVITATE SHUTDOWN	<p>Pump has cavitated and shut down.</p> <ul style="list-style-type: none"> <li>• Event is reset when Liebert® iCOM™ requests a new startup.</li> </ul>
PB1 IN PRES SENS FAIL	<p>Inlet refrigerant pressure sensor failure. Pump shut down.</p> <ul style="list-style-type: none"> <li>• Event is reset when condition clears.</li> </ul>
PB1 IN TEMP SENS FAIL	<p>Inlet refrigerant temperature sensor failure. Pump shut down.</p> <ul style="list-style-type: none"> <li>• Event is reset when condition clears.</li> </ul>
PB1 INV DATA SHUTDOWN	<p>Invalid data detected and pump shut down.</p> <ul style="list-style-type: none"> <li>• Event is reset when Liebert® iCOM™ requests a new startup.</li> </ul>
PB1 LO DIFF PRESSURE	<p>Pump differential pressure fell below a lower threshold and pump shut down.</p> <p>Event is reset when Liebert® iCOM™ requests a new startup.</p>
PB1 LO OUTLET TEMP	<p>Pump outlet-refrigerant temperature fell below a lower threshold and pump was shut down.</p> <ul style="list-style-type: none"> <li>• Event is reset when Liebert® iCOM™ requests a new startup.</li> </ul>
PB1 OUT PRES SEN FAIL	<p>Outlet refrigerant pressure sensor failure. Pump shut down.</p> <ul style="list-style-type: none"> <li>• Event is reset when condition clears.</li> </ul>

**Table 4.4 Events Specific to Liebert® EconoPhase (continued)**

Event	Description
PB1 OUT TEMP SEN FAIL	Outlet refrigerant-temperature-sensor failure. Pump shut down. <ul style="list-style-type: none"> <li>Event is reset when condition clears.</li> </ul>
PB1 CAN DISCONNECTED	Liebert® iCOM™ lost CAN communications with pump board. Pump shut down. <ul style="list-style-type: none"> <li>Event is reset when condition clears.</li> </ul>
PB1 REMOTE SHUTDWN	Remote shut-down requested. Pump shut down. <ul style="list-style-type: none"> <li>Event is reset when condition clears.</li> </ul>
PB1 STARTUP FAIL	Three pump start up attempts in a row have failed. <ul style="list-style-type: none"> <li>Event must be reset manually.</li> </ul>
PB2 BOARD FAIL	An unrecoverable failure of the pump control board occurred. Pump shut down. <ul style="list-style-type: none"> <li>Reboot pump board to reset event.</li> </ul>
PB2 CAVITATE SHUTDOWN	Pump has cavitated and shut down. Event is reset when Liebert® iCOM™ requests a new startup.
PB2 IN PRES SENS FAIL	Inlet refrigerant-pressure-sensor failure. Pump shut down. <ul style="list-style-type: none"> <li>Event is reset when condition clears.</li> </ul>
PB2 IN TEMP SENS FAIL	Inlet refrigerant-temperature-sensor failure. Pump shut down. <ul style="list-style-type: none"> <li>Event is reset when condition clears.</li> </ul>
PB2 INV DATA SHUTDOWN	Invalid data detected and pump shut down. <ul style="list-style-type: none"> <li>Event is reset when Liebert® iCOM™ requests a new startup.</li> </ul>
PB2 LO DIFF PRESSURE	Pump differential pressure fell below a lower threshold and pump shut down. <ul style="list-style-type: none"> <li>Event is reset when Liebert® iCOM™ requests a new startup.</li> </ul>
PB2 LO OUTLET TEMP	Pump outlet-refrigerant-temperature fell below a lower threshold and pump shut down. <ul style="list-style-type: none"> <li>Event is reset when Liebert® iCOM™ requests a new startup.</li> </ul>
PB2 OUT PRES SEN FAIL	Outlet refrigerant pressure-sensor failure. Pump shut down. <ul style="list-style-type: none"> <li>Event is reset when condition clears.</li> </ul>
PB2 OUT TEMP SEN FAIL	Outlet refrigerant temperature sensor failure. Pump shut down. <ul style="list-style-type: none"> <li>Event is reset when condition clears.</li> </ul>
PB2 CAN DISCONNECTED	Liebert® iCOM™ lost CAN communication with pump board. Pump shut down. <ul style="list-style-type: none"> <li>Event is reset when condition clears.</li> </ul>
PB2 REMOTE SHUTDWN	Remote shut-down requested. Pump shut down. <ul style="list-style-type: none"> <li>Event is reset when condition clears.</li> </ul>
PB2 STARTUP FAIL	Three pump start-up attempts in a row have failed. <ul style="list-style-type: none"> <li>Event must be reset manually.</li> </ul>
PB1 COMMUNICATE FAIL	Ethernet communications failure. Pump not shut down. <ul style="list-style-type: none"> <li>Event is reset when condition clears.</li> </ul> USB communications failure. Pump not shut down. <ul style="list-style-type: none"> <li>Event is reset when condition clears.</li> </ul>

**Table 4.4 Events Specific to Liebert® EconoPhase (continued)**

Event	Description
PB2 COMMUNICATE FAIL	<p>Ethernet communications failure. Pump not shut down.</p> <ul style="list-style-type: none"> <li>Event is reset when condition clears.</li> </ul> <p>USB communications failure. Pump not shut down.</p> <ul style="list-style-type: none"> <li>Event is reset when condition clears.</li> </ul>
PB1 COND TO PUMP TEMP	<p>Temperature variance from condenser 1 output to pump 1 input exceeds allowed parameters. Pump shut down.</p> <ul style="list-style-type: none"> <li>Event is reset when Liebert® iCOM™ requests a new start up.</li> </ul>
PB2 COND TO PUMP TEMP	<p>Temperature variance from condenser 2 output to pump 2 input exceeds allowed parameters. Pump shut down.</p> <ul style="list-style-type: none"> <li>Event is reset when Liebert® iCOM™ requests a new startup.</li> </ul>
MM Cycle Lock Out	<p>Liebert® EconoPhase operating in Mixed Mode has failed to control cooling 10 times in 6 hours.</p> <ul style="list-style-type: none"> <li>Mixed Mode operation is disabled until the event is manually reset.</li> </ul>
PB Cycle Lock Out	<p>Liebert® EconoPhase in Pump Mode has failed to control cooling 5 times consecutively at full-pump-capacity temperature conditions.</p> <ul style="list-style-type: none"> <li>Liebert® EconoPhase operation is disabled until the event is manually reset.</li> </ul>

**Table 4.5** on the facing page, describes events available with the Vertiv™ Liebert® DSE compressor.

**Table 4.5 Events Specific to Liebert® DSE Compressor**

Event	Description
COMP 1A OVERLOAD	<p>Compressor overloaded.</p> <ul style="list-style-type: none"> <li>The corresponding compressor is disabled until the condition resets. Some external overloads may require the device to be reset manually.</li> </ul>
COMP 1B OVERLOAD	
COMP 2A OVERLOAD	
COMP 2B OVERLOAD	
COMP 1A HRS EXCEEDED	<p>Compressor run-hour limit exceeded by actual run hours.</p>
COMP 1B HRS EXCEEDED	
COMP 2A HRS EXCEEDED	
COMP 2B HRS EXCEEDED	
COMP 1A HIGH TEMP	<p>High discharge temperature. Compressor is powered off.</p>
COMP 1B HIGH TEMP	
COMP 2A HIGH TEMP	
COMP 2B HIGH TEMP	
COMP 1A DISCH SENSOR FAIL	<p>Compressor discharge pressure sensor failed.</p>
COMP 1B DISCH SENSOR FAIL	
COMP 2A DISCH SENSOR FAIL	
COMP 2B DISCH SENSOR FAIL	

**Table 4.5 Events Specific to Liebert® DSE Compressor (continued)**



Event	Description
COMP 1A SHORT CYCLE	Compressor exceeded the maximum number of stop/starts allowed in the time period.
COMP 1B SHORT CYCLE	
COMP 2A SHORT CYCLE	
COMP 2B SHORT CYCLE	
CIRCUIT 1 HIGH PRESS	Circuit 1 or 2 high discharge pressure.
CIRCUIT 2 HIGH PRESS	
CIRCUIT 1 LOW PRESS	Circuit 1 or 2 low suction pressure.
CIRCUIT 2 LOW PRESS	

**Table 4.6** below, describes events available with the EEV alarm board.

**Table 4.6 Events Specific to EEV Alarm Board**

Event	Description
EEV 1 or 2 Communication Error	<p>Liebert® iCOM™ lost communication with the EEV board.</p> <ul style="list-style-type: none"> <li>The compressor(s) shut-off and the unit exits Liebert® EconoPhase while the error is active.</li> </ul>
EEV 1 or 2 Sensor Error	<p>Liebert® iCOM™ lost communication with a connected EEV sensor.</p> <ul style="list-style-type: none"> <li>If a sensor value is not reported for 10 seconds, a sensor error occurs. The compressor(s) shut-off and the unit exits Liebert® EconoPhase while the error is active.</li> <li>If 4 sensor errors occur in a 30-minute window, the Sensor Error event remains active until reset manually.</li> </ul>
EEV 1 or 2 Motor Error	<p>Problem with the stepper motor.</p> <ul style="list-style-type: none"> <li>The corresponding compressor(s) are disabled until the condition is cleared.</li> </ul>
EEV 1 or 2 Low Superheat	<p>Superheat dropped below 1°F (-17°C) for 1 minute.</p> <ul style="list-style-type: none"> <li>The corresponding compressor(s) are powered-off for the minimum "off time" while the event is active.</li> </ul>
EEV 1 or 2 High discharge temp	<p>Discharge temperature exceeded the high-temperature threshold.</p> <ul style="list-style-type: none"> <li>The corresponding compressor(s) are powered-off until the alarm is manually reset.</li> </ul>
EEV 1 or 2 Feedback Failure	<p>The EEV control monitors feedback from the compressor contactor. Feedback Failure is reported if the contactor is de-energized while the EEV is operating for superheat control.</p> <ul style="list-style-type: none"> <li>The corresponding compressor is disabled until the alarm is manually reset.</li> </ul>
EEV 1 or 2 Battery Warning	<p>The EEV control tests the EEV battery back-up (if included), and indicates low battery life.</p> <ul style="list-style-type: none"> <li>If this warning remains active for 24 hours, a battery failure event occurs and the circuit is locked-out.</li> </ul>
EEV 1 or 2 Battery Failure	<p>The EEV control tests the EEV battery backup (if included), and indicates battery failure.</p> <ul style="list-style-type: none"> <li>The corresponding EEV circuit is locked-out until the failure code is reset. See <a href="#">Resetting EEV Battery Failure Counter</a> on page 170.</li> </ul>
EEV 1 or 2 Driver Failure	<p>EEV unexpectedly closes with the compressor(s) powered on.</p> <ul style="list-style-type: none"> <li>The corresponding compressor is disabled until the alarm is reset manually.</li> </ul>
Comp 1 or 2 High Superheat	<p>Superheat is above the high threshold for 30 minutes.</p> <ul style="list-style-type: none"> <li>The compressor is powered-off for the minimum off time.</li> </ul>

## 4.4 Enabling the Audible Alarm Notification

1. Touch , then  > *Display Options* > *Display Properties*. The UNIT DISPLAY panel opens.
2. Touch the *Alarm Buzzer Pattern* value, and select a pattern from the drop-down list.
  - Selecting *None* disables the audible notification.
3. Touch *Save* to save the property settings.
  - Touch *Cancel* to discard changes.

## 4.5 Remote Alarm Device and Customer Input Events

Remote alarm devices are various sensors and detectors outside the cooling unit that provide information about conditions and situations that may affect operation. Remote alarm devices include smoke detectors, filter condition, valve status.

Included in the remote alarm devices option are up to four customer input events depending on cooling unit configuration. In some cases, 2 additional, optional customer-input events are available. See [Setting Up Customer Input Events](#) below .



Remote alarm devices and customer input notifications are set in the same way as other events. See [Selecting Event Type and Setting Alarm/Warning Notification](#) on page 83 .

### 4.5.1 Setting Up Customer Input Events

Input devices must be wired to Terminal 24 through a dry contact to locations 50, 51, 55 and 56 for alarms 1 through 4 respectively (For the terminal location, refer to the cooling unit electrical schematic and installation manual). **Table 4.7** below , maps the customer input to the remote alarm devices (RAD).

**Table 4.7 Customer Input Terminals to Remote Alarm Device Terminals**

Customer Input	Customer-Input Terminal	RAD Number	RAD Terminal
1	24	1	50
2	24	2	51
3	24	3	55
4	24	4	56

1. Touch , then  > *Alarm/Event Setup* > *Remote Alarm Device Input*. The EDIT panel opens.
2. In *Customer Input X* (where *X* is the input number), select the input type that best describes the wired device/input, see **Table 4.8** on page 95 .
3. In *Customer Input X Active When*, select whether the input is active (triggers events) when *Opened* or *Closed*.
4. Once input(s) are set, touch *Save*. The customer-input settings are saved.



## Customer Input Options

### Customer Input X

Selects the customer wired input, where X is the input number. See **Table 4.8** on page 95, for a description of available values.

### Customer Input X Active When

Selects when the input triggers an event. Options are:

- Opened: Events are triggered when the contacts across the corresponding RAD terminal strip are open.
- Closed: Vents are triggered when the contacts across the corresponding RAD terminal strip are closed.

**NOTE: Depending on customization, some events listed in Table 4.8 on the facing page, may not be available with your system.**

**Table 4.8 Customer Input Options**

Input	Action/Description
Smoke	Event only.
Water Alarm	Event only.
C PMP Alarm	Event only.
Flow Alarm	Event only.
Stdby G Pmp	Event only.
Stdby Unit	Event only.
C-Input 1	Event only.
C-Input 2	Event only.
C-Input 3	Event only.
C-Input 4	Event only.
Rht Lockout	Event + Electric heaters disabled.
Hum Lockout	Event + Humidifier disabled.
Rht+Hum Lock	Event + Electric heaters and humidifier disabled.
Comp Lockout	Event + Compressor(s) disabled w/o pump down.
Call Service	Event only.
High Temp	Event only.
Air Loss	Event only.
FC Lockout	Event + Free-cooling disabled.
Heater Alarm	Event + Heaters off.
Flow AL SD	Event + Shut-down the unit.
Flow AL LC	Event + Lockout compressors, no pump down. (Enabled only if at-least one compressor is operating. Auto-reset depends on input status.)
Comp Lock PD	Event + Compressor(s) disabled w/ pump down
Enable FC	Forces free-cooling to "On."
HTRJ VFD	Activates the HEAT REJ VFD ALARM. No other function.
HTRJ SPD	Activates the HEAT REJ SPD ALARM. No other function.
FIRE ALARM	Event + Shuts-down the unit.
2ND SETPOINT	No event, but switches to the second setpoint.
Emergency Power	Event + Disables unit.
LSI	Event + Activates humidifier-problem Alarm and stop filling bottle when full.
COND 1 FAIL	Event only.
COND 2 FAIL	Event only.
D-SCROLL RED	Event + Reduces requested compressor capacity by 20%.

**Table 4.8 Customer Input Options (continued)**

Input	Action/Description
SWAP VALVE	No event -Active X valve closes and Y opens/Inactive Y closes and X opens. See 7.3 - Custom Dual Chilled Water Valve Staging.
EC FAN FAULT	Event + Set analog output to 10 V.
ECO AIRFLOW	Event + Reduce Liebert® air economizer air flow.
DAMPERSWITCH	Damper + End switch.
POWER A	Event only.
POWER B	Event only.
Flow AL LFC	Activates event 'LOSS OF FLOW' and stops fluid free cooling operations.
Hand Mode	Activates event 'HAND MODE' when unit is on.
Fan Overrd.	Sets the fanspeed to the value defined by parameter S151 'Airflow Calibration'
Cool Overrd.	Sets call for cooling (CFC) to 100%.
Fluid Source 1	Triggers event 'FLUID SOURCE 1' indicating a loss of flow on supply source 1, no further reaction.
Fluid Source 2	Triggers event 'FLUID SOURCE 1' indicating a loss of flow on supply source 2, no further reaction.
ATS	Changes the ATS status switch in Service/Diagnostics menu from 'PS1' to 'PS2', and drives the front-screen Power Source information, no further reaction.
ATS PS1	Changes the ATS PS1 status switch in Service/Diagnostics from 'OK' to 'NOK', no further reaction.
ATS PS2	Changes the ATS PS2 status switch in Service/Diagnostics from 'OK' to 'NOK', no further reaction.
Harmonic Filter Temp	Triggers event 'HARMONIC FILTER TEMP' and shuts the unit down.
Door Open	Triggers event 'DOOR OPEN' and shuts unit down.
Water Leak Internal	Triggers event 'WATER LEAKAGE', no further action.
Max Cool Fan	Drives call for cooling (CFC) and call for fan speed (CFC) to 100% output.

**NOTE: Max Cool operation may cause Liebert® DSE unit to transition out of Liebert® Econophase or Mixed Mode operation and into full mechanical cooling.**

**NOTE: When Max Cool is utilized on Liebert® DSE, upon exiting Max Cool operation, Liebert® iCOM™ shall reassess current conditions prior to transitioning to Liebert® Econophase (PRE pump) or Mixed Mod operation.**

This page intentionally left blank

## 5 U2U Networking

Vertiv™ Liebert® iCOM™-controlled thermal management units connected in an Ethernet unit to unit (U2U) network are able to efficiently cool and control humidity in the conditioned space by exchanging data in several modes of operation.

U2U networking is required to set up and control the following operating features:

- Teamwork
- Standby (lead/lag)
- Rotation
- Cascading

**NOTE: The U2U network must be separate from other networks. Use a communication card, such as a Vertiv™ Liebert® IntelliSlot™ Unity, to communicate securely between your building-management system or other networks.**

### 5.1 Preparing for U2U Group Set Up

Cooling units in the network will be assigned to groups, which affects how units function in teamwork, standby, rotation, and cascading operations. Especially in large rooms, it is important to consider several factors before setting up groups to balance cooling unit operation with room conditions.

**NOTE: For ease of set-up and use, we recommend using only one group unless you have multiple rooms, differing software versions, or different types of cooling units.**

1. Make a map of the room and indicate the location of all heat-generating devices and cooling units to plan for proper heat load management and cooling-air distribution.
2. Note the type of units by product/model, size, etc.
3. Determine the number of units to network together to ensure proper air flow and environmental control, up to 32 units.
4. Determine number of standby units.
5. Determine if using teamwork and if so, which mode.
6. Plan U2U address assignments.
  - Refer to the [U2U Control Board Settings](#) on page 99 , for guidelines assigning cooling unit control board addresses.
  - Balance/Alternate unit address assignments based on room layout and because standby and teamwork operate in numeric order by unit number. **Figure 5.1** on the next page , shows an example layout assignment with half of the cooling units in standby and half operating. Without a plan, adjacent units could be operating or inactive, which may not provide proper heat-load balance or efficient use of cooling capacity.
7. Read and record all programmed settings for each of the individual units (see [Backing Up and Restoring Control Board Settings](#) on page 163 ).
8. Verify that network cabling and switches are provided, ready to connect, and labeled by unit at the network switch.

**NOTE: Cooling units are factory-wired for stand alone operation. Do not connect the U2U network cabling before setting the U2U network configuration/groups. Network communication conflicts and unreliable display readings will result. Configure the network using [Configuring U2U Network Settings](#) on the next page , then refer to [U2U Wiring Connections](#) on page 197 , to connect the network cabling and hardware.**

Figure 5.1 Example Layout Standby/Operating Unit Address Assignment

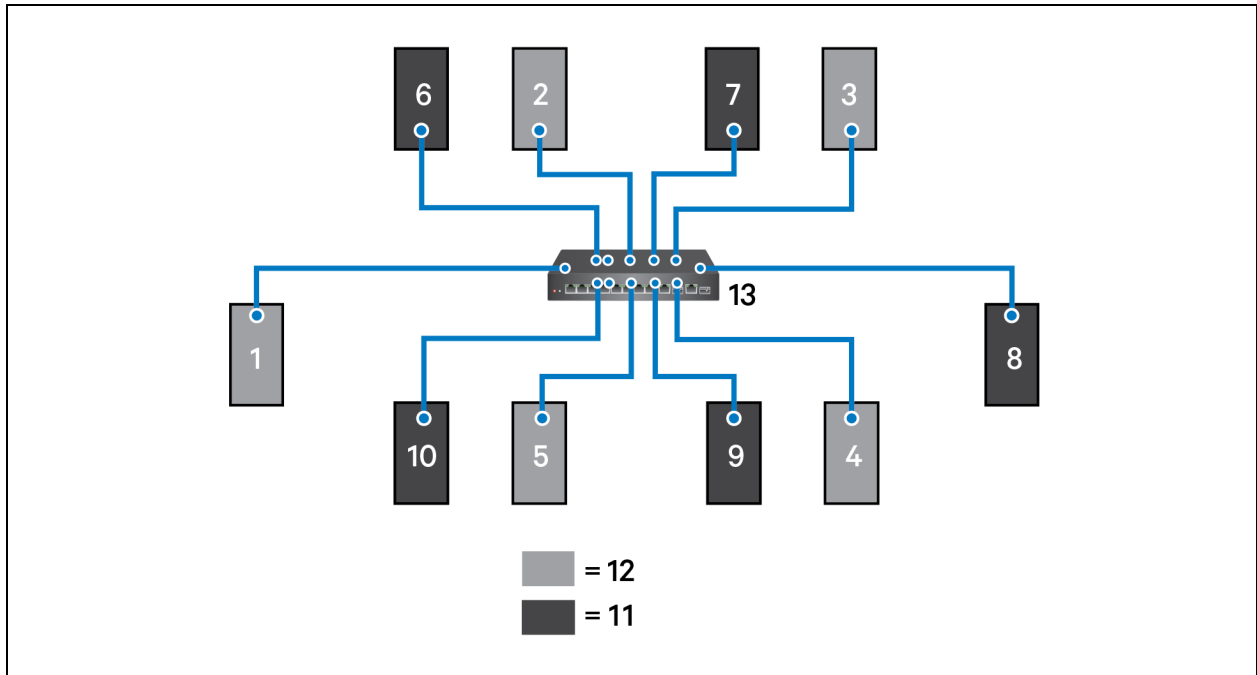



Item	Description
1 to 10	Assigned address of the thermal management unit
11	Operating units.
12	Units on standby
13	Network switch

## 5.2 Configuring U2U Network Settings

The U2U NETWORK SETTINGS configure Vertiv™ Liebert® iCOM™’s unit to unit communication and includes

information buttons, , that display pop-up field descriptions. The panel also indicates issues with the network settings. For resolution, see [Troubleshooting Network Settings Issues](#) on page 100 .

To configure unit to unit networking:

1. Touch , then  > *BMS & Teamwork Setup* > *U2U Setup*. The U2U NETWORK SETTINGS panel opens.
2. Touch the field to edit. The keypad opens.
3. Type the entry and touch .
4. When all fields to edit are updated, touch *Save & Restart*.

**NOTE:** Depending on the changes made, the Save button updates to indicate the components that need rebooted or restarted. If the control board reboots, the cooling unit suspends operation for 60 seconds, then resumes operating.

## 5.2.1 U2U Control Board Settings

### Broadcast

Logical address at which connected units receive datagrams.

**NOTE: Messages sent to the broadcast address is typically received by all network-attached hosts.**

### CB Firmware Version

Display configuration based on the firmware version of the control board, as follows:

- PA-2.06: CW/DS, DSE, PDX/PCW

### Gateway

Routes data and acts as proxy server/firewall for control board during network set up. Display and control board must be identical on the U2U network.

### IP Address

Network address of the control board.

**NOTE: Last three digits must be a unique value and need not be sequential. However, we recommend that they match the U2U address for easier reference later.**

### Netmask

Divides IP addresses in subnet and specifies network available to hosts for the control board.

### MAC Address

Unique, read-only identifier of the control board Ethernet device.

### U2U Address

Unique identifier for each control board on the U2U network. Address range is 1 to 32 and must be consecutive from the previous control board address in the U2U group. This is the address used for standby/lead lag and cascade operation, see **Figure 5.1** on the previous page .

**NOTE: We recommend matching the U2U address to the last three digits of the IP address for easier reference later.**

### U2U Group

For the control board, selects the zone/group with which the unit will be configured in teamwork/standby/rotation scenarios.

**NOTE: Units with a specific thermal area of influence should be assigned to the same zone/group, typically when a network spans separate rooms rather than by aisles. Groups are also handy when cooling units vary by cooling type, compressor type, or version of Liebert® iCOM™ firmware and otherwise do not operate together efficiently or at all.**

## 5.2.2 Troubleshooting Network Settings Issues

At the bottom of the U2U NETWORK SETTINGS panel, an Issues button indicates whether or not there are problems with the network settings. The button indicates the number of issues and changes color when a problem exists, see **Table 5.1** below .

**Table 5.1 Issues Button Status Colors**



Color	Description
Green	No problems. Number of issues is zero.
Red	Problem(s) detected. Number of issues displays.

To view network issues:

1. When an issue is indicated, touch the Issues(s) button on the U2U NETWORK SETTINGS panel. The ISSUES dialog opens.
2. Note the problems and *Close* the dialog, then address the issue:
  - Touch the setting to correct. The on-screen keyboard opens.
  - Make adjustments and touch *Go*.
  - Continue making corrections until no problems are indicated.
3. Verify that unit to unit communication is established, then touch *Save*.

**NOTE: Depending on the changes made, the Save button updates to indicate the components that need rebooted or restarted. If the control board reboots, the cooling unit suspends operation for 60 seconds, then resumes operating.**

## 5.2.3 Modifying U2U Network Settings

1. Touch , then  > *BMS & Teamwork Setup* > *U2U Setup*. The U2U NETWORK SETTINGS panel opens.
2. Touch the setting to edit and make adjustments, then touch .
3. Verify that unit to unit communication is established, then touch *Save*.

**NOTE: Depending on the changes made, the Save button updates to indicate the components that need rebooted or restarted. If the control board reboots, the cooling unit suspends operation for 60 seconds, then resumes operating.**



## 6 Teamwork, Standby and Rotation for Cooling Units

U2U communication via private network and additional hardware (see [U2U Networking](#) on page 97) allows the following operating features for the cooling units:

- Teamwork
- Standby (Rotation)
- Cascade

### 6.1 Continuous Control with Virtual Master

The Virtual Master function maintains smooth control if group communication is compromised. In these operating configurations, a lead (master) unit is in charge of component staging in teamwork mode, unit staging, and standby rotation. If the lead unit gets disconnected, Vertiv™ Liebert® iCOM™ automatically assigns a virtual master, which assumes the responsibilities of the lead unit until communication is restored.



### 6.2 Teamwork Modes

When Vertiv™ Liebert® iCOM™ controlled thermal management units are connected to a network in a group or team, use teamwork to optimize performance and efficiency depending on the mode chosen and its application.

In a panel with Status content, the Teamwork Mode icon indicates the mode selected, **Figure 6.1** on the next page. Touching the icon displays the Teamwork dialog from which you can access the teamwork-control settings.

#### 6.2.1 To Set Up Teamwork

1. Touch the Teamwork-mode icon, then touch *Edit* on the teamwork dialog.  
– or –

Touch  , then  > *BMS & Teamwork Setup* > *Teamwork / Standby* > *TeamworkMode*.

2. Select the mode from the *Teamwork Mode* drop down in the TEAMWORK MODE CONTROL panel. The TEAMWORK/STANDBY panel opens.
3. Touch *Save*. Teamwork mode is set.
  - Touch *Cancel* to discard changes.

Figure 6.1 Teamwork Icons

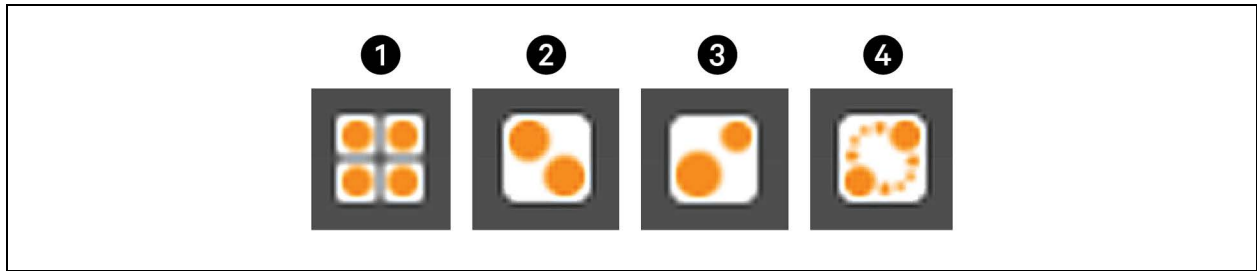

Item	Description
1	No teamwork.
2	Mode 1 - Parallel teamwork
3	Mode 2 - Independent teamwork
4	Mode 3 - Optimized aisle teamwork

**NOTE:** Depending on the type of thermal management unit, included components, and control settings of your system, all of the options listed may not be available on your Vertiv™ Liebert® iCOM™ display.

## Teamwork Control Options

### Qty. Units included in Average

Defines the quantity of units sensor values (X) within a given network group that are included within the 'System' average calculation and used for control. The primary unit ranks the units by temperature value of:

- Temperature Control Sensor value (for modes B and C)
- Fan Control sensor values (for modes A, D, and E).

Liebert® iCOM™ shall use the (X) highest sensor values to calculate the system average used for control.

**NOTE: This parameter is only available when units are configured for Teamwork Mode and the aggregation method is configured for "average".**

**NOTE: When Return Sensors are utilized for Fanspeed control, Return Sensor values on units placed in standby will not be used within the weighted aggregation of all Return Sensor values in the network group. Only Return Sensor values on operating units (Fan ON/Cooling ON) shall be included.**

**NOTE: When Remote Sensors are assigned to Fanspeed Control, Remote Sensor values on units in Standby shall be included within the weighted average and used for control.**

### Cascade Units

Stages on standby units based on room temperature/humidity load. Available in Teamwork modes 1 and 3, the options differ for each:

- Teamwork mode 1 Parallel options are:
  - Yes: Standby units cascade on based on a call for heating, cooling, humidification, or dehumidification.
  - Cool/Heat: Standby units cascade on with a call for heating or cooling only.
  - Cooling: Standby units cascade on with a call for cooling only.
- Teamwork mode 3 Optimized Aisle options are:
  - Fan P: Standby units cascade on based on the inability of active units to reach setpoint temperature or if using static pressure control, setpoint pressure while operating at full capacity.
  - Fan speed: Standby units cascade on based on the inability of active units to reach setpoint temperature or if using static pressure control, setpoint pressure while operating at full fan speed.

### Cascaded Units Delay

Length of time in minutes to delay the activation of a stand-by unit after the previously activated unit starts, to prevent staged cascaded units from starting too close together or at the same time.

### Cascaded Units Min Run

Length of time in minutes that an cascade on unit must run before powering off.

### Cascaded Units Off Delay

Length of time, in minutes, to delay powering-off a cascaded unit after fan speed drops below the *Stop Next Unit at SYS Fan Speed* setting.

**Cascaded Units Quick Start**

After a power cycle of the master unit, identical to Cascaded Units Delay except that it should be shorter to get units to start more quickly after a power cycle.

- This delay remains in effect until all cascaded units have been restarted, then the delay reverts to setting of Cascaded Units Delay.

**Max. Intermediate System Speed**

Limits the fan speed of the group until all units in cascade are powered on. Once all units are operating, the fan speed may increase beyond this setting.

**Number of Connected Units**

Number of units connected in the group if U2U networked.

**Start Next Unit at SYS Fan Speed**

Fan speed at which the next cascaded unit is powered on.

**Stop Next Unit at SYS Fan Speed**

Fan speed at which the next cascaded unit is powered off. Unit power off may be delayed by *Cascaded Units Off Delay*.

**Based on**

Select the way the sensor readings from each cooling unit in the group are used to control temperature and humidity. Options are:

- Maximum: based on the highest reading from a sensor in the group.
- Average: based on the average readings from the sensors in the group.

**Type**

Teamwork mode to use for the group.

**6.2.2 No Teamwork—Multiple Zones in One Room**

When a teamwork mode is not used, cooling units work independently based on their own sensors. Standby and unit rotation may be used, but cascading cannot.

**6.2.3 Teamwork Mode 1—Parallel Operation**

In Teamwork mode 1, fan speed and cooling capacity are ramped up in parallel, which means that all units operate identically.

Teamwork mode 1 is best for small rooms with balanced heat loads. A master unit collects the controlling readings for temperature and humidity from all the operating (fan on) units in the group, then determines the average or worst-case reading, and sends operating instructions to efficiently distribute cooling capacity across available units.

In Teamwork mode 1, most parameters are shared and, when set in any unit, are set in all units in the group.

**NOTE: Teamwork Mode 1 - Parallel is not supported on the Vertiv™ Liebert® DSE product line.**

## 6.2.4 Teamwork Mode 2—Independent Operation

Teamwork mode 2 works well for most applications, and best in large rooms with un-balanced heat loads by preventing units in a group from operating in opposing modes, some cooling and some heating. All temperature and humidity parameters are shared by the group. The master unit monitors all available unit-sensor readings and determines the demand for cooling, heating, humidification and dehumidification, then sends operating instructions to address the greatest demand.

In Teamwork mode 2, the setpoints for all units must be identical. The proportional band, deadband, and related settings may differ by unit. Fan speed is modulated per unit. Rotation and cascading is not available, so expect uneven distribution of work hours.

## 6.2.5 Teamwork Mode 3—Optimized Aisle Operation

In Teamwork Mode 3, the fan speed for all units operates in parallel, which means fan speed operation is identical at each unit. However, cooling capacity operates independently for each unit.

Teamwork mode 3 takes advantage of variable speed fan options and variable capacity component options to maintain rooms with an unbalanced load and to prevent units in a group from operating in opposing modes. All units operate in the same mode based on the average or worst case (maximum) readings from the unit sensors. A local control (cooling capacity supply sensor) provides input to manage and maintain the discharge-air temperature at each unit. In addition, fan speed and operation are controlled based on readings from the unit temperature or static pressure sensors to control air delivery to the cold aisle.

**NOTE: Standby and lead/lag are available when using optimized aisle mode, but is not recommended because it requires less power to run all units at reduced capacity.**

### Setting Up Teamwork Mode 3



Teamwork mode 3 requires the following:

- Vertiv™ Liebert® iCOM™ connection to a U2U network.
- Variable capacity compressors in the cooling unit.
- Variable speed fans in the cooling unit.
- Supply control air temperature sensors.



In addition, specific settings for wired remote (rack) sensors and setpoints are needed as described in the following steps.

#### To Set Up Optimized Aisle Operation





1. Set wired remote sensor function and mode:

- Touch , then  > *Auxiliary Device Setup* > *Sensors* > *Wired Remote Sensors*.
- Touch each sensor name, and select *Control* or *Reference* in *Function* based on rack set-up or preference, then touch *Save*.
- On the *SENSORS* panel, touch *Setup* under *Wired Remote Sensors*, and select *Maximum* or *Average* in *Unit Remote Sensors Mode*, then touch *Save*.  
See [Wired Remote Sensors](#) on page 157, for descriptions of all the wired remote sensor settings.

2. At each unit in the group:

- Touch , then  > *Setpoints* > *Temperature Control*.
- In *Temperature Control Sensor*, select *Supply Sensor*, then touch *Save*.
- In *Temperature Setpoint*, select the setpoint based on the cooling unit's area of influence, then touch *Save*.

3. At the master unit:

- Touch , then  > *Setpoints* > *Fan Control*.
- In *Fan Control Sensor*, select *Remote Sensor*, then touch *Save*.  
The other units in the group are set automatically.
- Touch , then  > *BMS & Teamwork Setup* > *Teamwork / Standby* > *Teamwork Mode*.
- In *Teamwork Mode*, select *3 Optimized Aisle*.
- In *Teamwork* is based on, select *Maximum* or *Average*, then touch *Save*.

Teamwork mode 3 is set.

4. Monitor operation of the cooling units and adjust setpoints and control bands as necessary.

## 6.3 Assigning Cooling Units to Standby (Lead/Lag)

Standby assigns some units to operate while others are on standby, meaning a unit is idle but ready to become active in the event of an alarm condition in one of the operating units or based on a rotation schedule.

When a unit is in standby mode, fan(s) are off and no cooling occurs. In multiple cooling unit systems, assigning units to standby lets you:



- Configure redundancy in case of failure scenarios (standby).
- Manage cooling unit run time (lead/lag). See [Setting a Rotation Schedule](#) on the facing page .
- Modulate for very low loads to full design load (to be temperature reactive) by cascading activation of standby units (configured when setting up teamwork mode).

The U2U network has built-in fail over conditions that are automatically employed when standby units have been assigned:

- During single cooling unit or component failure, a standby unit is activated to replace the failed unit.
- Alarm event causes unit shut down, a standby unit is activated. If the activated unit also has an alarm event, the next available standby unit is activated. If all units have an alarm event, and no more stand-by units are available, a unit with a non-critical alarm event will be activated.

**NOTE: Redundancy is employed if units are assigned to standby regardless of the teamwork mode selected, including no teamwork.**

### 6.3.1 To Set Up Lead/Lag Operation

1. Touch , then  > *BMS & Teamwork Setup* > *Teamwork / Standby*. The TEAMWORK/STANDBY panel opens.
2. Touch *Standby*. The STANDBY CONTROL panel displays.
3. Adjust the settings, then touch *Save*.
  - Touch *Cancel* to discard the changes.

## Standby Options

### High Temperature Threshold

Temperature at which all standby units are activated.

### Number of Standby Units

Number of units in standby mode.

### Standby Fan Timer at Reheat/Humidification



Length of time in minutes that the fan continues to operate after the cooling unit enters standby mode if reheat or the humidifier were operating when unit powered-off.

### Start All Standby Units by High Temperature

When enabled, all units are activated to cool when a high temperature alarm occurs.

## 6.4 Setting a Rotation Schedule

You can set a rotation schedule to switch operating and standby units to manage run-time of the cooling units.

1. Touch , then  > *BMS & Teamwork Setup* > *Teamwork / Standby*. The TEAMWORK/STANDBY panel opens.
2. Touch *Unit Rotation*. The UNIT ROTATION CONTROL panel displays.
3. Adjust the settings, then touch *Save*.
  - Touch *Cancel* to discard the changes.

### 6.4.1 Unit Rotation Options

#### Lead Lag Overlap Timer

Length of time in minutes that cooling units operate in parallel when one begins operating (from standby) and the other goes into standby.

#### Rotate At

Selects exact time at which rotation occurs. Adjustable, based on 24-hour clock where minutes are 0 to 59 and are 0 to 23.

#### Rotate By

Number of positions by which the cooling units rotate. For example, rotate by 3 in a group of 10 units and start with unit 1 operating. At rotation, unit 1 goes to stand-by and unit 4 activates, then 7, 10, 2, and so on. You can select 1 to 8 units in a single rotation schedule.

## Rotate Every

Selects rotation period. Valid values:

- 12 hrs
- 24 hrs

## Rotate Now

Immediately performs rotation.

## Rotation Frequency

Frequency at which rotation occurs. Options include:

- No: Rotation disabled.
- Daily: Rotation occurs every day.
- Every [Day of Week]: Rotation occurs weekly on the same day.
- Monthly [Day of Week]: Rotation occurs monthly on the same day.



## 6.4.2 Manually Rotating the Operating and Standby Units

You can rotate the operating and standby units outside of the set schedule using Rotate Now.

**NOTE: Manual rotation may only be performed at the cooling unit designated as the lead unit, “U2U Address = 1,” of the group.**



**NOTE: The Rotate Now button may only be available when a Rotation Frequency is selected. See [Setting a Rotation Schedule](#) on the previous page .**

1. At the cooling unit, verify that it is the lead unit of the group:

- Touch , then  > *BMS & Teamwork Setup > U2U Setup*.
- In the CONTROL BOARD column, verify that the *U2U Address* is 1.

If it is the lead unit, continue with step 2 .

If it is not the lead unit, find the lead unit and start at step 1 .

2. Touch , then  > *BMS & Teamwork Setup > Teamwork / Standby*. The TEAMWORK/STANDBY panel opens.
3. Touch *Unit Rotation*. The UNIT ROTATION CONTROL panel displays.
4. Touch *Rotate Now*, then touch *Save*. The operating and standby units are rotated.



## 7 Configuring Economizer Operation

Use Vertiv™ Liebert® iCOM™ to configure the economizer installed on your cooling unit.

**NOTE:** Depending on customization to your cooling system, one of two types of economizer may be installed: the Liebert® Fluid Economizer or the Liebert® Air Economizer. Menu options differ depending on the type of economizer installed and significant differences are noted when they occur.

### 7.1 Fluid Economizers

Fluid economizers provide a secondary chilled water or glycol coil (Vertiv™ Liebert® Econ-o-Coil) for cooling. Economizer operation is commonly referred to as free cooling because it reduces or eliminates the use of the compressor(s) in the right environmental conditions.

Your system may have one of two kinds of fluid economizers:

- GLYCOOL Economizer: A two pipe system that feeds a second glycol coil in the cooling unit and also the compressor(s) and heat exchanger (Liebert Paradenser™, tube-in-tube condenser, or brazed-plate heat exchanger).
- Dual Cool Economizer: A two pipe or four pipe system.
  - A two pipe system provides chilled water to a second coil, bypassing the air cooled/condenser compressorized loop.
  - In a four pipe system, two fluid lines are dedicated to a second chilled water coil and two fluid lines are dedicated to a glycol cooled or chilled water cooled compressorized loop.

The fluid economizer option appears on the Vertiv™ Liebert® iCOM™ service menu and opens the FLUID ECONOMIZER panel to configure operation.

#### 7.1.1 Fluid Economizer Control Options

##### Override

Configures cooling unit override of economizer operation. See [Overriding the Fluid Economizer Operation](#) on the next page .

##### Setup



Configures the activation setpoints of the economizer. See [Setting Up Fluid Economizer Operation](#) on the next page .

##### Status

Status of economizer properties. See [Viewing Fluid Economizer Statuses](#) on page 115 .

## 7.1.2 Overriding the Fluid Economizer Operation

Overrides the economizer’s settings with those of the cooling unit.

1. Touch , then  > *Economizer* > *Override*. The OVERRIDE panel opens.
2. Select the override settings and touch *Save*.

### Fluid Economizer Override Options

#### Enable Fluid Economizer

Enables/disables economizer operation.

#### Lockout FC at FC Fluid Below



When enabled, prevents frost on free cooling pipes by disabling the free cooling unit when the FC Fluid Temperature falls below the specified limit. The default setting is 32°F

#### Stop FC at Setpoint Value

Temperature at which free cooling is locked out.

## 7.1.3 Setting Up Fluid Economizer Operation

Configures activation points of the economizer. The sensors used to control/activate secondary cooling are room/local air temperature sensor or return-air sensor and an Aquastat Sensor (AQ) that measures the glycol/chilled water temperature.

1. Touch , then  > *Economizer* > *Setup*. The SETUP panel opens.

Indicator dots next to the parameters show the status of the property. **Table 7.1** below, describes the color dots that indicate whether or not differential temperature (DT) Between Room and Fluid Value (depending on the selection for DT Between Room and Fluid Value) is within range for economizer operation. Indicators must be green to condition the space using the economizer. If an indicator is yellow, the economizer will not condition the space.

2. Refer to the [Fluid Economizer Set Up Options](#) on the facing page, and [Temperature Control with a Fluid Economizer](#) on page 112, to adjust the setpoint options, then touch *Save*.

**Table 7.1 Economizer Property Status Indicators**

Indicator color	Definition
Green	The air or fluid meets the requirements for use.
Yellow	The air or fluid does not meet requirements and is ineligible for use.

**NOTE: Depending on the type of economizer with your system, all of the options listed may not be available on your Vertiv™ Liebert® iCOM™ display.**

## Fluid Economizer Set Up Options

### DT Between Room and Fluid Type

Selects the glycol/chilled water temperature input used by the comparator circuit to determine if the DT warrants use of secondary cooling.

- Disabled: Disables the second cooling source in dual cool configurations and is the default setting for standard, compressorized units and for chilled water units without a second cooling source.
- Contact: An external input is used to determine secondary cooling activation based on the open/closed status of the contact:

Open: Activate second cooling source.

Closed: Deactivate second cooling source.

- Temp: The difference between the fluid temperature and the room air temperature (Temperature Setpoint) determines use of secondary cooling. (The difference parameter is set with the DT between room and fluid value slider. When the difference is equal to or greater than the selected value, secondary cooling is used.)
- Set: Enables free cooling when the sensed fluid temperature is colder than the Temperature Setpoint. (The difference parameter is set using the DT between room and fluid value slider. When the difference is equal to or greater than the selected value, secondary cooling is used.)

### DT Between Room and Fluid Value

Temperature difference between fluid and room air at which secondary cooling activates. For example, when set at the factory default 12°F (-11.1°C), secondary cooling activates when the fluid temperature is 12 or more degrees colder than the room air temperature/setpoint.

### Minimum CW Temp

Enables/disables setting a minimum chilled water temperature that controls simultaneous operation of chilled water secondary cooling and compressor(s).

### Minimum CW Temp Value

Temperature of the fluid that determines whether or not secondary cooling and compressor(s) operate simultaneously:

- If the fluid temperature is below the minimum temperature and if the temperature differential is satisfied (DT between room and fluid value), then the compressor(s) are locked out and the secondary chilled-water coil provides cooling.

**NOTE: If secondary cooling fails (for example, loss of water flow), this setting is overridden and the compressor(s) activated. If this occurs, free cooling is locked out for one hour.**

- If the fluid temperature is above the minimum temperature, chilled water and the compressorized cooling will operate simultaneously if needed.

### Enable Free Cooling Flush

Number of hours between flushes of the free cooling coil.

### Free Cooling Flush Duration

Length of time the for flush of the free cooling coil.

### Free Cooling Flush Starts K11

When enabled, the Q15 relay is activated during the free cooling flush.

### Ramp Up Fan at 100% FC

Enables/disables an increase in fan speed when free cooling reaches 100% capacity.

## 7.1.4 Temperature Control with a Fluid Economizer

When an economizer is installed, the cooling requirement (determined by the temperature proportional band) is addressed first by the economizer's secondary cooling, if the economizer cooling capacity is insufficient, the compressor(s) begin cooling to bring the room air temperature down to the temperature setpoint.

The fluid economizer employs a motorized ball valve that controls the flow of chilled water/glycol to provide a cooling capacity from 0% to 100%.

### Simultaneous Operation, Partial Economizer Operation, and Staging Cooling Sources

When simultaneous operation of the compressor(s) and secondary cooling is enabled, the portion of the proportional band assigned to the fluid capacity valve may be reduced by the comparator circuit based on the DT settings. When this occurs, the compressor control proportional band moves closer to the setpoint, and compressorized cooling begins before secondary cooling reaches 100% (as shown in the example [Secondary Cooling Temperature Control with Two Step Compressor](#) on the facing page ) or shuts off.



**CAUTION:** On units with a GLYCOOL fluid economizer and standard scroll or semi-hermetic compressors without unloaders, there is a risk of over cooling and low refrigerant pressure when free cooling/secondary cooling operates simultaneously with compressor/DX cooling. Make sure adequate flow is provided when 100% free cooling and compressorized cooling occur at the same time. If the fluid temperature is too cold while the compressors are running, the refrigerant pressure will drop. Contact technical support at 1-800-543-2778, opt. 5 for more information on setting up simultaneous operation.

**NOTE:** The compressor control method is not affected by economizer operation and operates across the assigned proportional band based on the compressor configuration of your system (1 step, 2 step, 4 step, or digital scroll). See [Compressor Control by Cooling Requirement](#) on page 29 , for a description compressor control methods.

## Secondary Cooling Temperature Control with Two Step Compressor

When the fluid temperature meets the set up requirements, secondary cooling provides temperature control as follows. If the fluid is not cold enough, primary compressorized cooling operates as normal.

**NOTE: The compressor control method is not affected by economizer operation and operates across the assigned proportional band based on the compressor configuration of your system (one step, two step, four step, or digital scroll). See Compressor Control by Cooling Requirement on page 29 , for a description compressor control methods.**

- 70° temperature setpoint
- 8° temperature proportional band
- 2° temperature deadband

In **Figure 7.1** on the next page :

The proportional band is divided evenly on each side of the setpoint, and an additional half of the proportional band is added to the cooling side for 200% cooling.

- At 71° air temperature (cooling demand 0%), the fluid control valve is closed.
- As cooling demand increases from 0% to 100%, the fluid control valve opens incrementally to increase cooling capacity proportionally until fully open at 75° (cooling demand 100%).

**NOTE: If simultaneous operation of economizer cooling and compressor (DX) cooling is enabled, the compressor(s) may begin operation before the valve is open 100% because the fluid temperature differential is calculated to provide insufficient cooling.**

- At 100% cooling demand, the compressor control method is employed across the additional half of the proportional band, a single scroll compressor with unloaders in this example:
  - The compressor starts unloaded at 77° when the cooling requirement is 150%.
  - At 79° when the cooling requirement is 200%, the compressor operates loaded until 77° is reached when cooling requirement is 150% when it returns to unloaded operation.

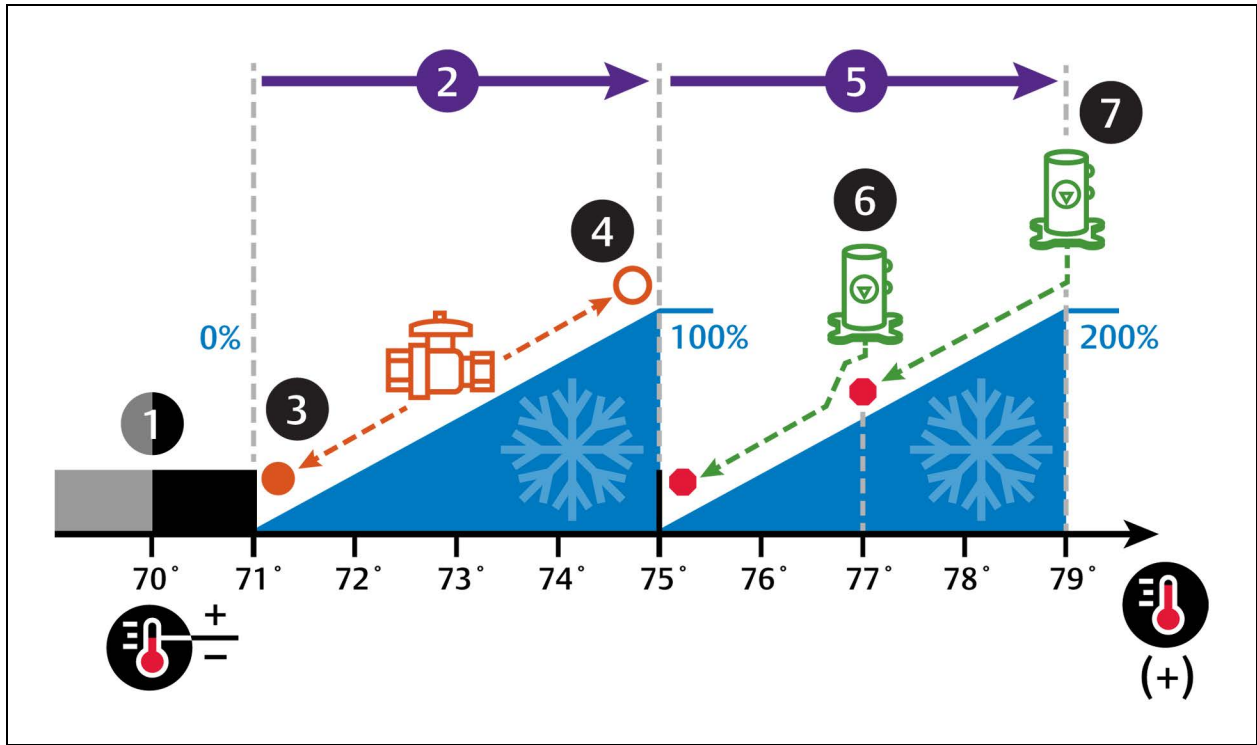

Figure 7.1 Temperature Control—Fluid Economizer and Example Two Step Compressor Capacity



No.	Description	No.	Description
1	Deadband.	5	½ of proportional band assigned to compressor(s) operation.
2	½ of proportional band assigned to valve operation.	6	Scroll compressor step 1. (Compressor 1 in dual compressor configuration, Unloaded in single compressor configuration.)
3	Fluid control valve closed.	7	Scroll compressor step 2. (Compressor 2 in dual compressor configuration, Loaded in single compressor configuration.)
7	Fluid control valve fully open.		

## 7.1.5 Viewing Fluid Economizer Statuses

Display the status of the economizer features installed in the cooling unit.

- Touch , then  > *Economizer* > *Status*. The STATUS panel opens.
  - If the status indicators are not all green, the economizer is not used to condition the unit. To adjust the settings, see [Setting Up Fluid Economizer Operation](#) on page 110 .

### Fluid Economizer Status Options

#### FC Capacity

Cooling capacity of the fluid economizer.

#### Free Cooling Fluid Temperature

Current temperature of the free cooling fluid.

This page intentionally left blank



## 8 External Monitoring and Building Management Systems

Vertiv™ Liebert® iCOM™-controlled cooling units are equipped with embedded Liebert® IS-Unity-DP™ software to communicate with external monitoring systems including Building Management Systems (BMS), Network Monitoring Systems (NMS) and Vertiv™ Liebert® SiteScan™ Web.

Embedded Unity communicates with multiple third-party protocols to monitor and manage a range of parameters and events. The Embedded Unity software delivers:

**NOTE: Because the Liebert® iCOM™ U2U network must be separate from other networks, use external monitoring or BMS to communicate securely between networks.**

- Velocity Protocol for Vertiv™ Trellis™, Vertiv™ Liebert® SiteScan™ and Vertiv™ Liebert® Nform.
- Embedded Vertiv™ LIFE™ Technology for Remote Service Delivery.
- SNMP (v1/v2/v3) for NMS.
- HTTP/HTTPS for web page viewing.
- SMTP for e-mail.
- SMS for mobile messaging.
- Modbus RTU-Modbus Remote Terminal Unit communication protocol for BMS over an RS-485 serial network (Modbus RTU RS-485).
- Modbus TCP-Modbus Transmission Control Protocol for BMS over Internet or LAN.
- BACnet IP—BACnet over Internet Protocol for BMS over Internet or LAN.
- BACnet MSTP—BACnet Primary-Secondary/Token-Passing communication protocol for BMS over an RS-485 serial network (Modbus MSTP RS-485).

### 8.1 BMS and Vertiv™ Liebert® IntelliSlot™ Settings

When communicating with a building management system (BMS) with an optional Liebert® IntelliSlot™ Unity card or via embedded Unity function, the BMS settings are identical and include:



- Disconnect fail safe
- Manual fan speed control
- Allowing the BMS to change fan speed
- Backup fan control

#### 8.1.1 Configuring BMS Communication with Embedded Unity

By default, built-in Unity function is disabled. You must enable communication with the BMS via the IS-UNITY options in Vertiv™ Liebert® iCOM™.

To configure Modbus, BACnet, SNMP, SMS, SMTP, and HTTP communication, see [Communication Setup with Embedded Unity](#) on page 120.

#### To Enable Embedded Unity Function

1. Touch , then  > *BMS & Teamwork* > *BMS Setup*.  
The BMS SETUP panel opens.

2. Select *IntelliSlot Card Settings* and one of the following in *Monitoring Protocol*:
  - *Embedded* to use built-in Unity function.
  - *Embedded & IS V4* to use built-in Unity and additional IntelliSlot™ card or SiteLink connection.
3. Touch *Save & Restart (Unit Only)*.

## IntelliSlot Options

### Monitoring Address

Address used by an optional, installed IntelliSlot™ card. Factory default is 3.

- Do not modify the monitoring address unless directed to do so by Vertiv technical support.



### Monitoring Protocol

Protocol used for communication with BMS. Options are:

- Velocity V3: Legacy Velocity communication card.
- IGM: IGMNet communication cards.
- Velocity V4: IntelliSlot™ Card or Sitelink/Sitescan™. This is the factory default.
- Embedded: Embedded IS-UNITY function.
- Embedded and IS V4: To use built-in Unity and an additional IntelliSlot card or SiteLink/Sitescan connection.

**NOTE: If a Sitelink/Sitescan Connection and MODBUS RTU or BACnet MSTP RS-485 connection is required simultaneously, then the purchase of the RS-485 expansion board is required.**

## 8.1.2 Setting BMS Control Settings

1. Touch , then  > *BMS & Teamwork* > *BMS Setup* > *Control Settings*. The CONTROL SETTINGS secondary panel opens.
2. Adjust the settings, and touch *Save*. The settings are configured.

**NOTE: Use Configure Timeout to configure the setpoints used in the event of an outage and BMS takes control. See [Setting BMS Backup Setpoints](#) on the facing page .**

**NOTE: Depending on the type of thermal management unit, included components, and control settings of your system, all of the options listed may not be available on your Vertiv™ Liebert® iCOM™ display.**

### BMS Control Settings Options

#### BMS is Connected To

- Velocity
- Analog Input 1-4

#### BMS Fan Speed Local Override

Enables/disables local override of the fan-speed set via BMS.

### Fan Control Sensor

Currently-selected fan control sensor. Must be set to Manual for BMS control. See [Configuring Fan Setpoints](#) on page 43.



### Monitoring Handshake

Sets a time period, in minutes, in which communication between the BMS and Vertiv™ Liebert® iCOM™ must occur.

### Maximum Fan Speed

Current fan speed setting (set via fan setpoints or by BMS).

## 8.1.3 Setting BMS Backup Setpoints

1. Touch , then  > *BMS & Teamwork* > *BMS Setup* > *Configure Timeout* button on the lower-right of the panel. The CONFIGURE TIMEOUT secondary panel opens.
2. Adjust the values, and touch *Save*. The settings are configured.

**NOTE:** Depending on the type of thermal management unit, included components, and control settings of your system, all of the options listed may not be available on your Vertiv™ Liebert® iCOM™ display.

### BMS Timeout Settings Options

#### BMS Backup Fan Operation

Enables/disables BMS operation of the fans during back up operation. Options are:

- **Disabled** - There is no reaction when BMS is disconnected. Unit shall remain as is.
- **BMS Backup Spd** - Fanspeed shall change to setting defined by parameter S162 "BMS Backup Fanspeed" when the BMS is disconnected.
- **Coupled** - Links the call for fanspeed percentage (%) to the call for cooling percentage (%). The fan shall still ramp between the minimum percentage and the STD speed percentage (MAX), still respecting the airflow calibration.
- **BMS Backup Set** - When configured, the current fan setpoint used for control (S147 "Fan Setpoint") shall be replaced by value configured by Liebert® iCOM™ parameter S162 "BMS Backup Fan Setpoint".
- **SP Control** - S146 "Fan Control Sensor" shall change back from 'Manual' to 'Return' and the static pressure related to the fan speed starts at the most recent BMS manual speed, eventually controlling to that speed.

The BMS timer must be configured for this setting to activate.

#### BMS Backup Temp Setpoint

Temperature that the cooling unit maintains during BMS back up operation.

## 8.2 Communication Setup with Embedded Unity

The following sections describe the configuration options for embedded Unity function including Modbus, BACnet, SNMP, SMS, SMTP, and HTTP communication.

**NOTE:** The Unity configuration is also accessible through the Unity web interface. For details on accessing and using the web interface, refer to the *Liebert® IntelliSlot™ Unity Card Installer/User Guide*, available at [www.vertiv.com](http://www.vertiv.com).

IS-UNITY setup includes the following options to configure Unity function and communication:

- Connection
  - [Connecting to the BMS](#) below
  - [Embedded Unity User and Password](#) on page 124
  - [Troubleshooting Unity Connection and Set Up](#) on the facing page
- Configuration
  - [System Configuration](#) on page 124
  - [Local Users Configuration](#) on page 126
  - [Network Configuration](#) on page 127
  - [Web Server Configuration](#) on page 129
  - [Remote Services Configuration](#) on page 132
  - [Velocity Protocol Configuration](#) on page 135
  - [Messaging Configuration](#) on page 136
- Protocols
  - [BACnet Protocol Setup](#) on page 141
  - [Modbus Protocol Setup](#) on page 144
  - [SNMP Protocol Setup](#) on page 146
- [Unity Status Readings](#) on page 150
- [Unity Support Information](#) on page 151

### 8.2.1 Connecting to the BMS

The embedded Unity software resides on the Vertiv™ Liebert® iCOM™ control board. There are two methods of connecting to a BMS, via Ethernet or RS-485.

For a network connection, connect the Ethernet cable from the BMS to P74 on the Liebert® iCOM™ control board. **8.2.1** above, shows the connector location.

For an RS-485 connection, connect the serial cable from the BMS to TB3 on the Liebert® iCOM™ control board. Pin 1 is the positive terminal on the right in on the facing page.

If the optional RS-485 expansion board is purchased, TB1 on the expansion board is used for BACnet MSTP or MODBUS RTU and TB3 on the Liebert® iCOM™ board directly to a Sitelink/Sitescan system.

Please see [Configuring BMS Communication with Embedded Unity](#) on page 117

### Troubleshooting Unity Connection and Set Up

Figure 8.1 RS-485 Expansion Board

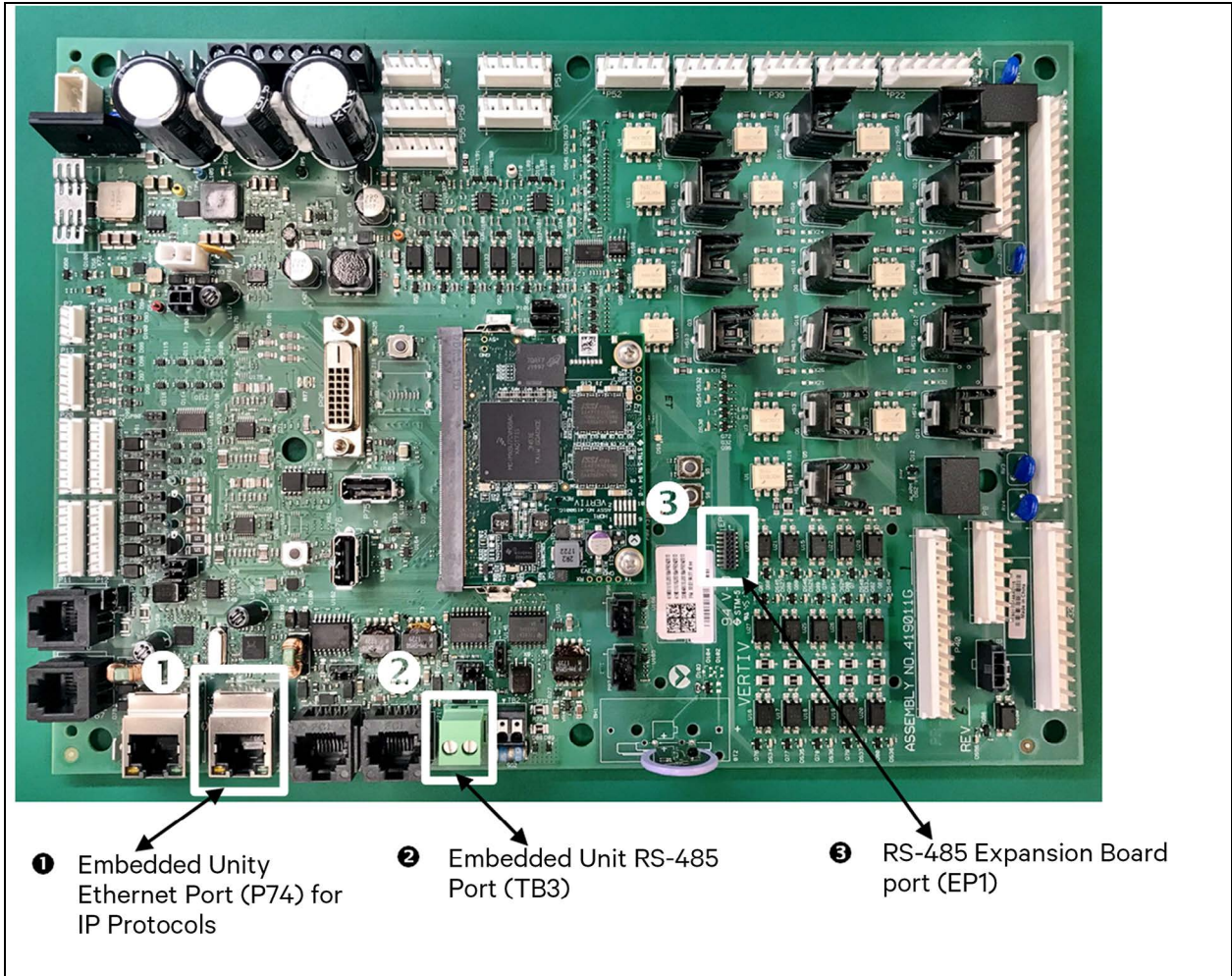

- ❶ Embedded Unity Ethernet Port (P74) for IP Protocols
- ❷ Embedded Unit RS-485 Port (TB3)
- ❸ RS-485 Expansion Board port (EP1)

No.	Description
1	Embedded Unity Ethernet port (P74) for IP protocols
2	Embedded Unity RS-485 Terminal Block (TB3) for BACnet or Modbus over twisted pair
3	RS-485 Expansion board port (EP1)

The expansion board is needed only if there is a requirement to do Velocity 4 to Vertiv™ Liebert®IntelliSlot™ based cards and BACnet or Modbus RS-485 simultaneously. See **Figure 8.2** on the next page for the expansion board.



Figure 8.2 Expansion Board



NOTE: The TB1 for RS-485 Terminal Block is used if a Sitelink/Sitescan connection and MODBUS or BACnet MSTP is required simultaneously.

**Table 8.1** below, lists problems you may encounter with the Unity software and possible solutions.

**Table 8.1 Embedded Unity Troubleshooting**

Problem	Possible cause	Suggested Remedy
Settings are not available in local unit Liebert® iCOM™ display, show as "IS-Unity Service is Unavailable"	Embedded Unity is not enabled.	Make sure the correct monitoring protocol is selected in BMS Setup. See <a href="#">Configuring BMS Communication with Embedded Unity</a> on page 117 .
	Unity software needs more time to boot up since most recent Liebert® iCOM™ controller or Unity reboot.	Wait no more than 10 minutes to give enough time to boot up.
	The Liebert® iCOM™ user and password for Unity are incorrect.	Enter a valid user name and password for the Liebert® iCOM™-to-Unity connection. See <a href="#">Embedded Unity User and Password</a> on the next page .
	Embedded Unity has crashed.	Restart, and wait at least 5 minutes to fully boot up. See <a href="#">Unity Restart and Restore Defaults</a> on the next page .
	Unity configuration had become corrupt.	Restore to defaults, see <a href="#">Unity Restart and Restore Defaults</a> on the next page . <b>NOTE: All customized Unity configuration settings will be lost. Use this as a last resort.</b>
Ethernet to BMS network not communicating or connecting	BMS Ethernet drop is connected to the wrong RJ-45 connector on the Liebert® iCOM™ control board.	Make sure that the cable is connected to P74 on the Liebert® iCOM™ control board, and corrected if needed.
	Ethernet cable is bad or incorrectly made.	Use a cable tester that gives a quality rating and length (sends a true data packet) to test the cable and correct as needed.
	Incorrect network settings.	Correct the IPv4 network settings, see <a href="#">IPv4 and IPv6 Configuration</a> on page 128 . <b>NOTE: If you adjust the settings, you must restart the Unity software for the changes to take effect.</b>
485 twisted pair to BMS network not communicating or connecting	Incorrect polarity.	Correct the polarity. See <a href="#">Connecting to the BMS</a> on page 120 .
	Incorrect protocol settings.	Verify and correct the settings. Refer to the configuration settings that apply to your system: <ul style="list-style-type: none"> <li>• <a href="#">BACnet Protocol Setup</a> on page 141 .</li> <li>• <a href="#">Modbus Protocol Setup</a> on page 144 .</li> <li>• <a href="#">SNMP Protocol Setup</a> on page 146 .</li> </ul>
	Protocol settings have not been saved.	Save the settings, and restart Unity so the configuration is authorized/applied. See <a href="#">Unity Restart and Restore Defaults</a> on the next page .

## 8.2.2 Embedded Unity User and Password



Changes to the Unity configuration are authenticated with a user/password that is stored in Vertiv™ Liebert® iCOM™. The stored user name and password must match that of a user account in embedded Unity, see [Local Users Configuration](#) on page 126 , for a description of the Unity accounts.

You will be prompted to create a new administrator login in the initial setup.

**NOTE: CWE-521, Password Complexity requires the following:**

**Minimum of 8 to a maximum of 30 case-sensitive, printable characters (excluding: \ '<>~?#, double quote and space). Also must contain a combination of upper and lower case, digit and special characters. The password cannot contain the username.**

If you are not using the default combination in Unity, then you must update Liebert® iCOM™ with the matching username and password.



1. Touch , then  > *BMS & Teamwork* > *IS-Unity Settings*.
2. Adjust the Username and Password, and touch Save.

## 8.2.3 Unity Restart and Restore Defaults



Some types of configuration changes require a restart of the embedded Unity software to take effect. Using the Restart IS-Unity option, does not affect the Vertiv™ Liebert® iCOM™ controller.

You also have the option of restoring the configuration to factory defaults if communication problems occur and cannot be remedied with troubleshooting

### To Restart Embedded Unity

1. Touch , then  > *BMS & Teamwork* > *IS-Unity Settings*.
2. Touch *Restart IS-Unity*, then Save.



### To Reset the Configuration to Factory Defaults

1. Touch , then  > *BMS & Teamwork* > *IS-Unity Settings*.
2. Touch *Default IS-Unity Setup*, then Save.

## 8.2.4 System Configuration



System displays general information about the monitored and managed device. You can select the temperature units displayed, which is Celsius by default.

### To Update the System Settings

1. Touch , then  > *BMS & Teamwork* > *IS-Unity Setup* > *Configuration* > *System*.
2. Adjust the information, and touch Save. The settings are configured.



## Time Service Settings

1. Touch , then  > *BMS & Teamwork > IS-Unity Setup > Configuration > System > Time Service*.
2. Adjust the settings, and touch Save.

## Time Service Setting Options

### External Time Source

The external source to use for time synchronization. Default is NTP Server.

### Primary NTP Time Server

URL, Hostname, or IP address of the primary NTP time source. Has a 64 character maximum.

### Backup NTP Time Server

URL, Hostname, or IP address of the back-up NTP time source. Has a 64 character maximum.

### NTP Time Sync Rate

The rate at which time will be synchronized with the network time protocol server, if NTP is the external time source.

### Time Zone

Time zone where the device is located.

### Enable Auto-Sync to Managed Device

Enable automatic writing time to the managed device.

### Managed Device Auto-Sync Rate

Rate at which time will be written to the managed device, if an external time source has been selected.

## 8.2.5 Local Users Configuration

Local Users offers up to 10 users and three access levels described in **Table 8.2** below .

The default password for all users is *Liebert* (case sensitive).

**Table 8.2** User Access Levels



Level Name	Access/Permission Type	Description
No Access	None	The No Access level is enforced when Password Protected Site is enabled.
General User	Read-only	Able to view all tabs, folders and sub-folders of the user interface. A General User will only need to enter the assigned password if Password Protected Site is enabled, see <a href="#">Web Server Configuration</a> on page 129 .
Administrator	Read/Write	Able to edit settings using the assigned password, which is always required to edit settings/configuration.  CWE-521: Minimum of 8 to a maximum of 30 case-sensitive, printable characters (excluding: \<>~?#, double quote and space). Also must contain a combination of upper and lower case, digit and special characters. The password cannot contain the username.

**IMPORTANT! Record user names and passwords and save them in a secure place where they can be found if forgotten. A lost password cannot be retrieved from the IS-UNITY card. If the administrator password is lost, the card must be reset to factory defaults and reconfigured.**



### To Change the User Names and Passwords

**NOTE:** CWE-521, Password Complexity requires the following:

**Minimum of 8 to a maximum of 30 case-sensitive, printable characters (excluding: \<>~?#, double quote and space). Also must contain a combination of upper and lower case, digit and special characters. The password cannot contain the username.**

1. Touch , then  > *BMS & Teamwork* > *IS-Unity Setup* > *Configuration* > *Users* > *User [n]*.
2. Enter a new user name and password.
3. Re-enter the password to confirm it.
4. In *Authorization for User*, select the type of access, see **Table 8.2** above .
5. Touch *Save*.

## 8.2.6 Network Configuration

1. Touch , then  > *BMS & Teamwork > IS-Unity Setup > Configuration > Network*.
2. Adjust the settings, and touch Save.

### Network Setting Options

#### Speed Duplex

Selects the speed and duplex configuration of the card's Ethernet port. It is set to Auto by default. If it requires changing, contact the system administrator for the proper settings.

#### Hostname

Identifies the network node. Default is *UNITY-serial\_number\_of\_card*.

#### Domain Name Suffix List

Listing of domain name suffixes for resolution of host names. If it requires changing, contact the system administrator for the proper setting.

#### Telnet Server



Enables/disables telnet access to the card to prevent unauthorized changes. The default setting disables telnet access.

#### SSHv2 Server

Enables/disables SSHv2 (Secure Shell) access to the card to prevent unauthorized changes. The default setting disables SSHv2 access.

## IPv4 and IPv6 Configuration

The IPv4 and IPv6 settings determine which internet protocol will be used for communication over the network connected to the Ethernet port. IPv4 and IPv6 networks will run in parallel (dual stack network), but the protocols are different. See your network administrator to determine which protocol should be enabled and to determine the correct settings.

1. Touch , then  > *BMS & Teamwork* > *IS-Unity Setup* > *Configuration* > *Network* > *IPv4 or IPv6*.
2. Adjust the settings, and touch Save.

## IPv4 Settings

### IPv4 Protocol

Enables IPv4 in the card

### IP Address Method

Mode the card boots into to be a network ready device (Static, DHCP, BootP). Default is DHCP.

### Static IP Address

Network address for the interface.

### Subnet Mask

Network mask for the interface which divides a network into manageable segments

### Default Gateway

IP address of the gateway for network traffic destined for other networks or subnets.

### DNS Server Address Source

Source of DNS server identification (None, Automatic, Configured).

### Primary DNS Server

Network address of the primary DNS server.

### Secondary DNS Server

Network address of the secondary DNS server.

## IPv6 Settings

### IPv6 Protocol

Enables IPv6 in the card.

### IP Address Method

Mode the card boots into to be a network ready device (Static, Auto). Default is Auto.

**Static IP Address**

Network address for the interface.

**Prefix Length**

Prefix length for the address that divides a network into manageable segments.

**Default Gateway**

IP address of the gateway for network traffic destined for other networks or subnets. Default is 64.

**DNS Server Address Source**

Source of DNS server identification (None, Automatic, Configured). Default is Automatic.

**Primary DNS Server**



Primary DNS Server

**Secondary DNS Server**

Secondary DNS Server

**Domain Name Server Test**

The Domain Name Server (DNS) test checks key points of a DNS setup for a given domain.

1. Touch , then  > *BMS & Teamwork* > *IS-Unity Setup* > *Configuration* > *Network* > *DNS Test*.
2. Adjust the settings, and touch *Save*.

**DNS Test Settings****Last Query Response**

Response from a DNS to the last query.

Example: *gxtwebdemo.liebert.com* resolved to *126.4.203.251*

**Type of Query**



Type of DNS query. (Hostname, IP Address)

**Query Value**

Value for the domain name server (DNS) to resolve. Example: *gxtwebdemo.liebert.com*

**8.2.7 Web Server Configuration**

Web Server Settings configures some security settings, such as HTTP or HTTPS, and password enabling.

1. Touch , then  > *BMS & Teamwork* > *IS-Unity Setup* > *Configuration* > *Web Server*.
2. Adjust the settings, and touch *Save*.

## Web Server Settings

### Web Server Protocol

Select the operation mode of the web server (HTTP, HTTPS).

### HTTP Port

Standard web port not encrypted. Required if HTTP is enabled as web server protocol. Default is 80. Must be set to 80 for correct Vertiv™ Liebert® iCOM™ connection.

### HTTPS Port

Standard secure web port; all communication is encrypted. Required if HTTPS is enabled as web server protocol. Default is 443. Must be set to 443 for correct Liebert® iCOM™ connection.

### Password Protected Site

When enabled, a log in session is required before any device information is displayed to the user. User level credentials will allow only viewing of device information. Administrator level credentials are required to make any changes. Default: enabled.

### Remote Write Access

When enabled, all web browsers have write access to data on all Unity card web pages when the user is logged in with Administrator credentials. When disabled, write access is restricted to web browsers connected on an Autoconfiguration IPv4 address. An Autoconfiguration IPv4 address is of the form 169.254.x.x, and is negotiated automatically when a direct connection is made between the Ethernet port of your PC and the Ethernet port of the Unity card. Regardless of this setting, all web browsers always have read access to the web pages (subject to the setting of the Password Protected Site parameter), and the diagnostic information file can be generated when the user is logged in with Administrator credentials (see [Unity Support Information](#) on page 151).

**NOTE: When remote write access is disabled, an indicator is displayed in the upper right corner of the web page as a reminder, shown in the following figure.**

**NOTE: Only disable remote write access if you are absolutely sure that you do not need to administer the managed device or the Unity card through a remote web browser session.**

### Session Idle Timeout

The interval the software will wait before logging off a user unless there is user activity. The default is five minutes.

## Certificate Configuration

When the web server protocol is configured to use HTTPS communications, all web server communication with all browsers is encrypted and validated based upon the security algorithms and validity checks specified in the SSL certificate that is currently installed in the card. By default, the card generates its own unique, self-signed SSL certificate when it is first powered up. However, many installations want to install and use SSL certificate files that were generated by their own Certificate Authority (CA).

Selections in Certificate provide commands to Upload SSL Certificate PEM Files or Generate Self-Signed SSL Certificate.

## Certificate Commands

### Generate Self-Signed SSL Certificate

Generates and installs a new self-signed certificate based on the mode selected for Generate Self-Signed SSL Certificate Mode. See [Generating a Self-Signed SSL Certificate](#) on the next page .

### Generate Self-Signed SSL Certificate Mode

Method used to generate a self-signed SSL certificate. Options are:

- Use Default Values: The values used in place of the user configurable fields are the same as those used when the original SSL certificate was generated by the card on first power up. The default values are not displayed.
- Use Configured Settings: The user entered values in the configurable fields are used to generate the certificate.

**NOTE: When using configured settings, all of the configurable fields, described below, must have an entry to successfully generate a certificate.**

### Common Name

Fully qualified domain name that browser clients will use to reach the card's web server when it is running with the certificate generated with the name entered here.

### Organization

Organization or company identified as the owner of the generated certificate.

### Organizational Unit

Organizational unit or company division of the organization identified as the owner of the generated certificate.

### City or Locality

City or locality of the organization identified as the owner of the generated certificate.

### State or Province

State or province of the organization identified as the owner of the generated certificate.



**Country Code**

Country code (two letter abbreviation) of the organization identified as the owner of the generated certificate.



**Email Address**

E-mail address of the contact within the organization identified as owner of the generated certificate.

**Generating a Self-Signed SSL Certificate**

1. Touch , then  > *BMS & Teamwork* > *IS-Unity Setup* > *Configuration* > *Web Server* > *Certificate*.
2. In Generate Self-Signed SSL Certificate Mode, select the mode to use.
  - If you select *User Configured Settings*, make entries in all of the configurable-value fields (required).
3. Touch *Save*.
4. Follow the instructions in the dialog to generate and install the certificate.

**8.2.8 Remote Services Configuration**

1. Touch , then  > *BMS & Teamwork* > *IS-Unity Setup* > *Configuration* > *Remote Services*.
2. Adjust the settings, and touch *Save*.

The folder contains sub-folders for connectivity and diagnostics:

- [Remote Services Connectivity](#) on the facing page
- [Remote Services Diagnostics](#) on page 134

**Remote Service Options and Settings****Serial Number From Device**

Serial number obtained from the managed device. Identifies the device to the system unless *Device Serial Number Override* is enabled.

**Reset Remote Services Config**

Resets configuration of the remote service back to factory defaults.

**NOTE:** Does not reset the communication card configuration.

**Remote Service**

Enables/disables remote service connection.

**Device Data Sampling**

Enables/disables, data sampling of the device.

**Device Serial Number**

Serial number used when *Device Serial Number Override* is enabled.



**Device Serial Number Override**

Enables/disables use of the serial number obtained from the managed device.

**Site Equipment Tag Number**

Number from the site equipment tag.

**Site Identifier**

Site identification number.

**Device Instance ID**

Manufacturer's device identification number.

**Service Center Country**

Country in which the device is serviced.

**Remote Services Connectivity****Remote Service Connectivity Options and Settings****Connectivity Test Result**

Result of most recent connectivity test.

**Test Connectivity**

Initiates connectivity test.

**Evaluate Remote Services Configuration**

Attempt to connect to the remote service to verify the configuration.

**Remote Service Platform URL**

URL address of the remote-service platform. Do not enter the "http://" or "https://" prefix.

**Connection Retry Time**

Length of time to attempt reconnection in the event of a communication failure. Range is 30 to 600 seconds.

**Proxy Enable**

Enables use of remote service platform URL to connect with a proxy server.

**Proxy Authentication**

Enables authentication of the proxy server.

**Proxy Address**

IP or URL address of the proxy server.

**Proxy IP Port Number**

Port number of the proxy server. Range is 1 to 65535.

**Proxy User Name**

User name of the proxy server.

**Proxy User Password**

Password of the proxy server.

**Remote Service Cloud URL**

URL address of the remote-service cloud. Do not enter the "http://" or "https://" prefix.

**Remote Services Diagnostics****Remote Service Diagnostic Settings****Communication Status**

Results of the most recent transaction.

**Communication Error Count**

Number of communication errors since reboot.

**Last Communications Error**

Most recent communication error message since reboot with date and time stamp.

**Monitored Device Rule File Information**

Details about the remote service rule file in effect for the monitored device.

**Remote Services Operating Status**

Status of the remote service.



**Managed Device Status**

Status of managed device's communication with the card.

## 8.2.9 Velocity Protocol Configuration

Velocity protocol contains four sub-folders: Managed Device, MSTP, Ethernet, and Internal.

**NOTE:** With the exception of changing the node ID when multiple cards are used or when disabling Velocity Protocol IP access, the settings in the Velocity Protocol sub-folders should not be modified unless directed by a Vertiv™ representative.

1. Touch , then  > *BMS & Teamwork* > *IS-Unity Setup* > *Configuration* > *Velocity Protocol*.
2. Adjust the settings, and touch Save.

### Velocity Protocol Options

#### Velocity Protocol IP Access

When disabled, prevents access from a remote, IP-based system using the Velocity Protocol.

#### Velocity Protocol Managed Device Options

##### Connection State

Status of connection to managed device.

##### FDM Version

Version of the managed device.

##### Product Sequence ID

Product sequence identifier of the managed device.

##### LAN Type

Type of interface connection to the managed device. Must be set to MSTP Internal for correct communication with Vertiv™ Liebert® iCOM™.

##### Node ID (MSTP Only)

Identifier of the managed device on an MSTP LAN.

##### IP Address (IP Only)

Address of the managed device on an IP LAN.

### Velocity Protocol MSTP Options

#### Interface

Type of MSTP interface.

#### Data Rate

Communication rate in bps.

### **Max Master Address**

Maximum node ID in-use on the MSTP interface.

### **Network Number**

Network number of the MSTP interface. 1 to 65534.

### **Node ID**

Node ID of the agent card on the MSTP LAN. 0 to 127.

## **Velocity Protocol Ethernet Options**

### **Velocity Protocol IP Port Number**

Port number of the IP interface, 1 to 65535.

### **Network Number**

Network number of the Ethernet interface, 1 to 65534.

## **Velocity Protocol Internal Options**

### **Network Number**

Internal network number used on the agent card. Not available to other interfaces.

## **8.2.10 Messaging Configuration**

Messaging enables and disables email and text messaging about events. It includes a test to determine if email and text messages can be successfully sent. Settings specify message recipients, the format of the messages, and other details.

### **Messaging Options**



#### **Email**

May be enabled to send email messages about events

#### **SMS**

May be enabled to send text messages about events

## E-mail Messaging Configuration

1. Touch , then  > *BMS & Teamwork > IS-Unity Setup > Configuration > Messaging > Email.*
2. Adjust the settings, and touch Save.

## E-mail Settings

### E-mail From Address

Sender's e-mail address. In most cases this will be the e-mail address of the person to whom replies should be sent. For example, *Support@company.com*

### E-mail To Address

E-mail address of the recipient. Multiple e-mail addresses should be separated by a semicolon.

### E-mail Subject Type

Subject of the email. This value will default to the event description. The subject line can be customized.

### Custom Subject Text

The subject of the email can be changed

### SMTP Server Address

Fully qualified domain name or IP address of the server used for relaying email messages. If using a server name, a DNS server may need to be configured under Network Settings.

### SMTP Server Port

SMTP server port.

### SMTP Connection

SMTP server connection type. Determines the capabilities of the SMTP server. Options are:

- Clear: Do not use encryption
- SSL/TLS: Encryption using SSL/TLS connection
- STARTTLS: SSL/TLS encryption initiated using STARTTLS.

### SMTP Authentication

Enable or disable email SMTP authentication. An e-mail account must be provided for the SMTP service provider to authenticate.

**NOTE: Some e-mail servers may require account-configuration changes to allow communication with the Unity card. For example, Gmail only recognizes Google applications as being secure. However, they provide an account setting that allows authentication with what they consider "less-secure apps." Please see your network administrator or service provider for configuration details.**

**SMTP Username**

Username of the e-mail account to use when e-mail SMTP authentication is enabled.

**SMTP Password**

Password for the e-mail account to use when e-mail SMTP authentication is enabled.

**Include IP Address in Message**

If checked, the IP Address of the agent card will be included in outgoing messages.

**Include Event Description in Message**

If True, SNMP event description will be included in outgoing messages.

**Include Name in Message**

If checked, the agent card Name will be included in outgoing messages.

**Include Contact in Message**

If checked, the agent card contact will be included in outgoing messages.

**Include Location in Message**

If checked, the agent card location will be included in outgoing messages.

**Include Description in Message**

If checked, the agent card description will be included in outgoing messages.

**Include Web Link in Message**

If checked, a web link to the agent card and web server listening port number will be included in outgoing messages.

**Enable Event Consolidation**

If checked, multiple events will be sent per outgoing message.



**Consolidation Time Limit**

If Event Consolidation is enabled, a message will be sent when Consolidation Time Limit seconds has passed since the first buffered event was received.

**Consolidation Event Limit**

If Event Consolidation is enabled, a message will be sent when the number of buffered events reaches the Consolidation Event Limit.

## SMS Messaging Configuration

1. Touch , then  > *BMS & Teamwork > IS-Unity Setup > Configuration > Messaging > SMS.*
2. Adjust the settings, and touch Save.

## SMS Settings

### SMS From Address

The sender's SMS address. In most cases this will be the SMS address of the person to whom replies should be sent. For example, Support@company.com.

### SMS To Address

The SMS address of the recipient. Multiple SMS addresses should be separated by a semicolon.

### SMS Subject Type

Subject of the message, either default or custom.

### Custom Subject Text

The subject of the message. The subject can be customized by the customer.

### SMTP Server Address

Fully qualified domain name or IP address of the server used for relaying SMS messages.

**NOTE: If using a server name, a DNS server may need to be configured under Network Settings.**

### SMTP Server Port

SMTP server port.

### SMTP Connection

SMTP server connection type. Determines the capabilities of the SMTP server. Options are:

- Clear: Do not use encryption.
- SSL/TLS: Encryption using SSL/TLS connection.
- STARTTLS: SSL/TLS encryption initiated using STARTTLS.

### SMTP Authentication

Enable or disable SMS SMTP authentication. An SMS account must be provided for the SMTP service provider to authenticate.

**NOTE: Some messaging servers may require account configuration changes to allow communication with the Unity card. For example, Gmail only recognizes Google applications as being secure. However, they provide an account setting that allows authentication with what they consider less-secure apps. Please see your network administrator or service provider for configuration details.**

**SMTP Username**

Username of the SMS account to use when SMS SMTP authentication is enabled.

**SMTP Password**

Password for the SMS account to use when SMS SMTP authentication is enabled.

**Include IP Address in Message**

If True, the IP Address of the agent card will be included in outgoing messages.

**Include Event Description in Message**

If checked, SNMP event description will be included in outgoing messages.

**Include Name in Message**

If checked, the agent card name will be included in outgoing messages.

**Include Contact in Message**

If checked, the agent card contact will be included in outgoing messages.

**Include Location in Message**

If checked, the agent card location will be included in outgoing messages.

**Include Description in Message**

If checked, the agent card description will be included in outgoing messages.

**Include Web Link in Message**

If checked, a web link to the agent card and web server listening port number will be included in outgoing messages.

**Enable Event Consolidation**

If checked, multiple events will be sent per outgoing message.

**Consolidation Time Limit**

If Event Consolidation is enabled, a message will be sent when Consolidation Time Limit seconds has passed since the first buffered event was received.



**Consolidation Event Limit**

If Event Consolidation is enabled, a message will be sent when the number of buffered events reaches the Consolidation Event Limit.





## Messaging Test

Tests the set up for e-mail and SMS messages. If the test fails, incorrect settings should be changed to ensure that proper notifications are sent if an event should occur.

1. Touch , then  > *BMS & Teamwork > IS-Unity Setup > Configuration > Messaging > Messaging Test.*
2. Enter the settings, select the type of test in *Send Test Message*, and touch *Save*.

## 8.2.11 BACnet Protocol Setup

1. Touch , then  > *BMS & Teamwork > IS-Unity Setup > Protocols > BACnet.*
2. Adjust the settings, and touch *Save*.
3. Configure the BACnet interface chosen.  
See [Configuring BACnet IP Protocol](#) on the next page, or [Configuring BACnet MSTP Protocol](#) on page 143.

The BACnet protocol does need to be enabled. See **Figure 8.3** below.

**Figure 8.3 IS-Unity Setup, Protocol Enable/Disable**

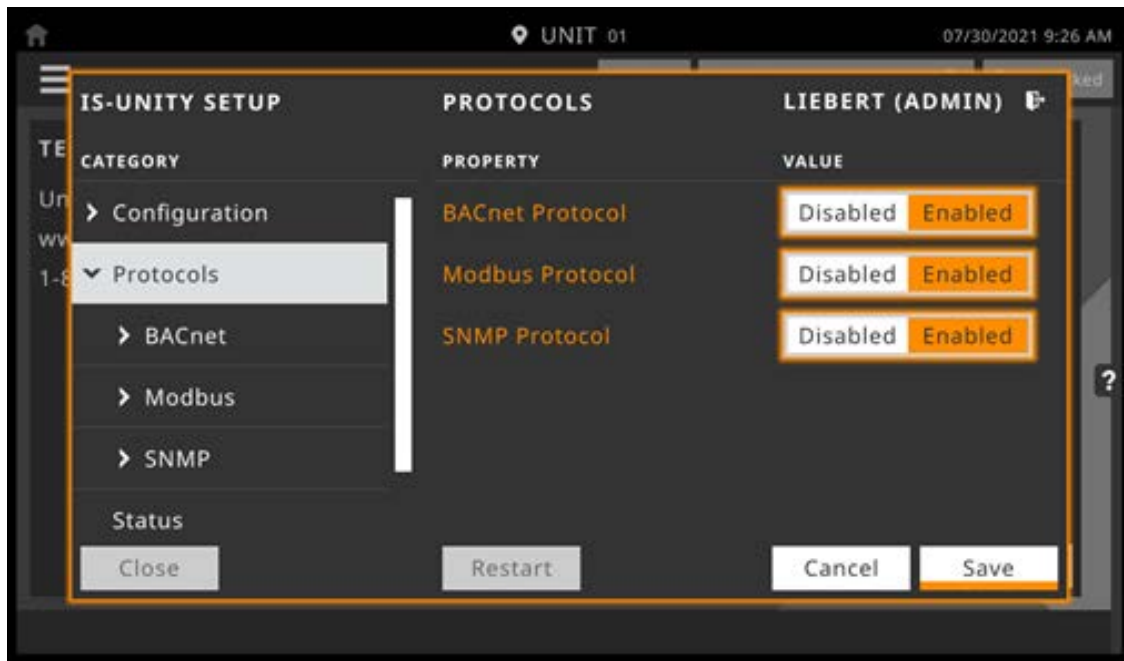

## BACnet Settings

### Managed Device Write Access

Enable or disable the BACnet server to write to the managed device.

### BACnet Interface

BACnet server interface: BACnet IP or BACnet MSTP.

**Device Object Instance Number**

The instance number (0-4194302) of the BACnet server's device object.

**Device Object Name**

The name of the BACnet server's device object.





**APDU Timeout**

The timeout in milliseconds between APDU retries (1-65535).

**APDU Retries**

The number of times to retransmit an APDU after the initial attempt (0-8).

**Configuring BACnet IP Protocol**

1. Touch , then  > *BMS & Teamwork* > *IS-Unity Setup* > *Protocols* > *BACnet* > *BACnet IP*.
2. Set the BACnet MSTP Node ID.
  - The Node ID defaults to 1, but must have a value from 0 to 127 that is unique among devices connected through the RS-485 interface.
3. Set the BACnet MSTP data rate.
4. Set the BACnet MSTP max master address.
5. Set the BACnet MSTP max info frames.
6. Touch *Save*.
7. Restart Unity:
  - a. Touch , then  > *BMS & Teamwork* > *IS-Unity Settings*.
  - b. Touch *Restart IS-Unity*., then touch *Yes*.

**BACnet IP Settings****BACnet IP Port Number**

The port for the BACnet server's UDP/IP connection.

**Register as Foreign Device**

Enable or Disable registration as a foreign device.





**IP Address of BBMD**

IP Address of the BACnet Broadcast Management Device (BBMD) to be accessed for Foreign Device Registration

**Foreign Device Time to Live**

Time to remain in the BBMD Foreign Device table after registration.

## Configuring BACnet MSTP Protocol

1. Touch , then  > *BMS & Teamwork > IS-Unity Setup > Protocols > BACnet > BACnet IP.*
2. Set the BACnet MSTP Node ID.
  - The Node ID defaults to 1, but must have a value from 0 to 127 that is unique among devices connected through the RS-485 interface.
3. Set the BACnet MSTP data rate.
4. Set the BACnet MSTP max master address.
5. Set the BACnet MSTP max info frames.
6. Touch *Save.*
7. Restart Unity:
  - a. Touch , then  > *BMS & Teamwork > IS-Unity Settings.*
  - b. Touch *Restart IS-Unity.*, then touch *Yes.*

## BACnet MSTP Settings

### Node ID

The BACnet server's MS/TP node ID (MAC).

### Data Rate

The BACnet MSTP communication rate (bits per second).



### Max Master Address

The maximum node ID (MAC) in use on the MS/TP network.

### Max Info Frames

Maximum number of information frames this node may send before it must pass the token.

## 8.2.12 Modbus Protocol Setup

1. Touch , then  > *BMS & Teamwork* > *IS-Unity Setup* > *Protocols* > *Modbus*.
2. Adjust the settings, and touch Save.
3. Configure the Modbus interface chosen. See [Configuring Modbus TCP Protocol](#) below , or [Configuring Modbus RTU Protocol](#) on the facing page .

### Modbus Settings

#### Managed Device Write Access

Enable or disable the Modbus server to write to the managed device

#### Modbus Interface





Select the Modbus interface, either Modbus TCP or Modbus RTU

### Configuring Modbus TCP Protocol

The Modbus TCP permits connection to the card by:

- Any client (open) permits communication by any IP address.
- Clients on the same subnet as the Unity card.
- Clients with specific IP addresses (Trusted IP Lists); only five addresses are permitted.

### To configure Modbus TCP

1. Touch , then  > *BMS & Teamwork* > *IS-Unity Setup* > *Protocols* > *Modbus TCP*.
2. Adjust the settings, and touch Save.
3. Restart Unity:
  - a. Touch , then  > *BMS & Teamwork* > *IS-Unity Settings*.
  - b. Touch *Restart IS-Unity*., then touch Yes.

### Modbus TCP Settings

#### Limit Network Access Type

IP Access List

- Open
- Same Subnet
- Trusted IP List



**Port**

The TCP port used by the Modbus server to listen for and respond to Modbus protocol requests based on Limit Network Access Type setting.

**Maximum Client Connection Count**

Displays the maximum client connection count.

**Configuring Modbus RTU Protocol**

1. Touch , then  > *BMS & Teamwork* > *IS-Unity Setup* > *Protocols* > *Modbus RTU*.
2. Enter the Node ID and the Baud Rate.
  - The Node ID defaults to 1, but must have a value from 1 to 247 that is unique among devices connected through the RS-485 interface.
  - The default baud rate is 9600. 19200 and 38400 are also available.

**NOTE: Contact your system administrator if you are uncertain about the settings.**

3. Touch *Save*.
4. Restart Unity:
  - a. Touch , then  > *BMS & Teamwork* > *IS-Unity Settings*.
  - b. Touch *Restart IS-Unity*., then touch *Yes*.

**Modbus RTU Settings****Node ID**

Modbus Server ID for the interface; obtain from network administrator.

**Baud Rate**

Communication rate.

- 9600
- 19200
- 38400





**Parity Check**

The communication parity check.

- None
- Even
- Odd

## 8.2.13 SNMP Protocol Setup

SNMPv1/v2c and SNMPv3 are enabled by default. The protocols may be configured or their default values may be accepted. Authentication traps are not enabled by default. The default heartbeat trap interval is 24 hours. This can be disabled or the interval may be changed.

1. Touch , then  > *BMS & Teamwork* > *IS-Unity Setup* > *Protocols* > *SNMP*.
2. To enable Authentication Traps, touch to select *Enabled*.
3. To change the Heartbeat Trap Interval, choose a time from the drop-down list or choose *Disabled* to prevent any heartbeat traps from being sent.
  - The interval times offered are 5 or 30 minutes, or 1, 4, 8, 12 or 24 hours.
4. For each trap, choose whether or not to disable or set the interval to one of the periods on the menu.
5. Touch *Save*.
6. Restart Unity:
  - a. Touch , then  > *BMS & Teamwork* > *IS-Unity Settings*.
  - b. Touch *Restart IS-Unity*., then touch *Yes*.

### SNMP Settings

#### SNMPv3 Engine ID

Read-only. The generated SNMPv3 engine ID.

**NOTE: A newly-generated ID appears only after rebooting the card.**

#### SNMP v1/v2c Enable

Enable or disable SNMP v1/v2c.

#### SNMP v3 Enable

Enable or disable SNMPv3.

#### Authentication Traps

When enabled, an authentication trap is sent if an SNMP host tries to access the card via SNMP, but either the host address is not in the SNMP access settings or it is using the wrong community string.

#### Heartbeat Trap Interval

Enable or disable and set interval 5 or 30 minutes, or 1, 4, 8, 12, or 24 hours.

#### RFC-1628 MIB

Enable or disable support for retrieval of data from the RFC-1628 MIB objects.

#### RFC-1628 MIB Traps

Enable or disable support for sending RFC-1628 traps.

## Liebert® Global Products (LGP) MIB

Enable or disable support for getting and setting data using the Liebert® Global Products MIB.

### LGP MIB Traps

Enable or disable support for Liebert® Global Products MIB traps.

**NOTE: LGP traps will not be sent unless LGP MIB is enabled.**

### LGP MIB System Notify Trap

Enable or disable support for the LGP System Notification trap. This is a single trap sent each time an alarm or warning is added or removed from the conditions table. It provides a text description of the event in a varbind of the trap message.

**NOTE: LGP System Notify traps will not be generated unless the LGP MIB is enabled.**

### SNMPv3 Engine ID Format Type

Selects method to build the engine ID. Valid values:

- MAC Address (default): Engine ID built from the Unity card's MAC address.
- Text: Engine ID built from text entered in SNMPv3 Engine ID Text. See [Select SNMPv3 Engine ID Format](#) below .



### SNMPv3 Engine ID Text

Text on which the engine ID is built when SNMPv3 Engine ID Format Type is *Text*.

**NOTE: If this field is left blank, the engine ID is built from the Unity card's MAC address.**

## Select SNMPv3 Engine ID Format

By default, the Engine ID is automatically generated using the MAC address. Optionally, you can select a text based ID instead.

1. Touch , then  > *BMS & Teamwork > IS-Unity Setup > Protocols > SNMP*.
2. Select the format. Refer to [SNMP Protocol Setup](#) on the previous page , for descriptions of the settings and options.
  - In SNMPv3 Engine ID Format Type, select *MAC Address* or *Text*.
  - If you selected *Text*, type the text on which the generated engine ID will be based.
  - Click *Save* to confirm the changes or *Cancel* to discard them.  
The new engine ID is not displayed until after rebooting the card in Step 3 .  
The text generated engine ID is a hexadecimal representation of ASCII characters similar to that shown in [Figure 8.4](#) on the next page .

**NOTE: If the format type or text for the Engine ID are incomplete or invalid, the Engine ID is generated based on the MAC Address.**



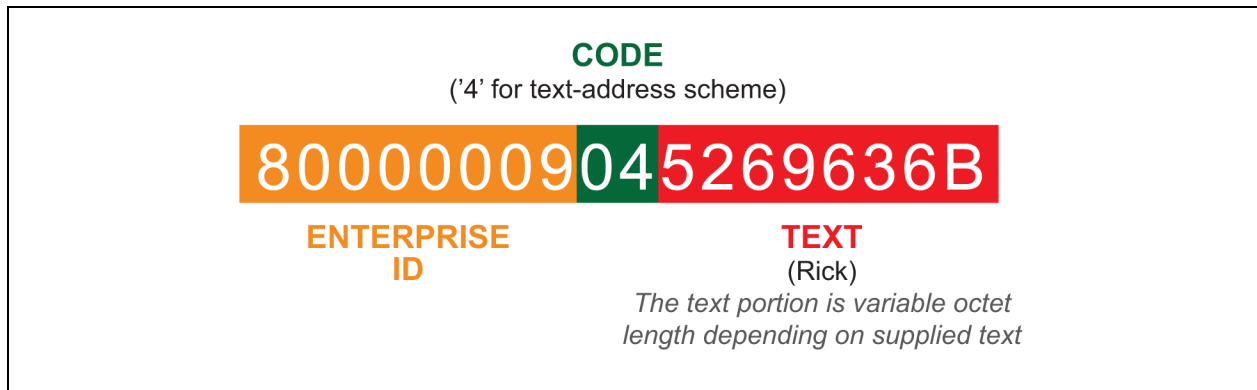

3. Restart Unity:
  - a. Touch , then  > *BMS & Teamwork > IS-Unity Settings*.
  - b. Touch *Restart IS-Unity*., then touch *Yes*.

Figure 8.4 SNMP Engine ID Generated Using Text Format Scheme



## Configuring SNMPv3 Users

IS-Unity supports up to 20 SNMPv3 users. The top level is a list of all 20.

1. Touch , then  > *BMS & Teamwork > IS-Unity Setup > Protocols > SNMP > SNMPv3 Users*, then one of the listed users.
2. Enter the information and set the permissions appropriate to the user, and touch *Save*.
3. Repeat steps 1 and 2 for additional users.
4. Restart Unity:
  - a. Touch , then  > *BMS & Teamwork > IS-Unity Settings*.
  - b. Touch *Restart IS-Unity*., then touch *Yes*.

## SNMPv3 User Settings

### SNMPv3 User Enable

Select to enable read, write or sending notifications with the user's credentials.

### SNMPv3 Username

The User name the authentication and privacy settings apply to. This string can be composed of printable characters except colon, tab, double quote, and question mark.

### SNMPv3 Access Type

Read-only, Read/Write, or Traps only

### SNMPv3 Authentication

Cryptographic algorithm used for authentication: None, MD5 or SHA-1



### SNMPv3 Authentication Secret

Pass phrase or password used for SNMPv3 Get request. This string can be composed of printable characters with the exception of colon, tab, double quote, and question mark. The entry must be from eight to 64 characters.

### SNMPv3 Privacy

Cryptographic algorithm used for encryption. Options are:

- None
- DES
- AES

### SNMPv3 Privacy Secret

Pass phrase or password used for SNMPv3 Get request. This string can be composed of printable characters with the exception of colon, tab, double quote, and question mark. The entry must be from eight to 64 characters.

### SNMPv3 Trap Target Addresses





Network hosts that will receive SNMPv3 traps, identified with either a network name or IP address. Multiple addresses must be separated by commas.

### SNMPv3 Trap Port

Port used by the target host for receiving SNMPv3 traps; default is 162.

## Configuring SNMPv1 Traps

You may configure up to 20 network hosts that receive SNMPv1 traps. The top level is a list of all 20.

1. Touch , then  > *BMS & Teamwork* > *IS-Unity Setup* > *Protocols* > *SNMP* > *SNMPv1 Traps*, then one of the listed traps.
2. Enter the information and set the permissions appropriate to the host/trap, and touch *Save*.
3. Repeat steps 1 and 2 for additional traps.
4. Restart Unity:
  - a. Touch , then  > *BMS & Teamwork* > *IS-Unity Settings*.
  - b. Touch *Restart IS-Unity*., then touch *Yes*.

## SNMPv1 Trap Settings

### SNMP Trap Target Addresses

Configure network hosts that will receive alert notifications (SNMP Traps). The host can be identified as either an IP address or the host's network name.

### SNMP Trap Port





Port used by the target host for receiving notifications; default is 162.

### SNMP Trap Community String

String identifying a secret known only by those hosts that want to be notified of device status changes.

## Configuring SNMPv1/v2c Access

Unity supports up to 20 network hosts that access data using SNMPv1/v2c. The top level is a list of all 20.

1. Touch , then  > *BMS & Teamwork* > *IS-Unity Setup* > *Protocols* > *SNMP* > *SNMPv1v2c Access*, then one of the listed access options.
2. Enter the information and set the permissions appropriate to the network host, and touch *Save*.
3. Repeat steps 1 and 2 for additional users.
4. Restart Unity:
  - a. Touch , then  > *BMS & Teamwork* > *IS-Unity Settings*.
  - b. Touch *Restart IS-Unity*, then touch *Yes*.

## SNMPv1/v2c Access Settings

### SNMP Access IP Address

Configure network hosts interested in device information access. The host can be identified as either an IP address or the host's network name.

### SNMP Access Type

SNMPv1/v2C access type: Read-only or Read/Write.

### SNMP Access Community String

SNMP Community String.



## 8.3 Unity Status Readings

The read-only Status page displays the system status of IS-Unity and a list of events that affect its status.

To view the statuses, touch , then  > *BMS & Teamwork* > *IS-Unity Setup* > *Status*.

## 8.4 Unity Support Information

Support displays information about IS-Unity for troubleshooting.

1. Touch , then  > *BMS & Teamwork* > *IS-Unity Setup* > *Support*.
2. Adjust the settings, and touch *Save*.

### Support Folder Settings

#### Agent Date and Time

Date and time setting for the card.

#### Agent Model

The card's model (Unity Platform).

#### Agent App Firmware Version

The card's firmware version (2.0 or higher).

#### Agent App Firmware Label.

The card's firmware label.

#### Agent Boot Firmware Version

The card's Boot firmware version.

#### Agent Boot Firmware Label

The card's boot firmware label.

#### Agent Serial Number

The card's serial number.

#### Agent Manufacture Date

The card's manufacture date.

#### Agent Hardware Version

The card's hardware version.

#### GDD Version

The card's GDD version, current when the card's firmware was installed; the GDD is a proprietary reference document for device data.

### **FDM Version**

The card's FDM version; the FDM is a data model document that defines data supported by devices that use the Velocity Protocol.

### **Product Sequence ID**



The card's product sequence identifier.

### **Device Assigned Label**

Displays the label assigned to the device.

## **8.4.1 Configuring Active Networking Settings**

Status of the currently active IP network settings for IS-Unity along with some previous values for troubleshooting IP communication issues.

1. Touch , then  > *BMS & Teamwork* > *IS-Unity Setup* > *Support* > *Active Networking*.
2. Adjust the settings, and touch *Save*.

### **Active Networking Settings**

#### **Ethernet MAC Address**

Ethernet MAC Address for the Embedded-Unity Ethernet interface.

#### **IPv4 Address**

Presently used IPv4 network address.

#### **IPv4 Default Gateway**

Presently used IPv4 network address of the gateway for network traffic destined for other networks or subnets.

#### **Primary DNS**

Presently used IPv4 Primary DNS.

#### **Secondary DNS**

Presently used IPv4 Secondary DNS.

#### **Last DHCP/BOOTP Address**

Last known IPv4 address assigned by DHCP.

#### **Last DHCP Lease**

Lease time of last known DHCP address.

**IPv6 Global Address**

Shows if DHCPv6 or Static address is presently being used.

**StateLess Address AutoConfiguration**

IPv6 SLAAC is assigned automatically from Router Advertisement, if "A" flag is set, combining Prefix with EUI-64 MAC.

**Link Local**

Presently used IPv6 Link Local Address.

**IPv6 Default Gateway**

Presently used IPv6 network address of the gateway for network traffic destined for other networks or subnets.

**Primary DNS Server**

IPv6 Primary DNS.

**Secondary DNS Server**

Presently used IPv6 Secondary DNS.

**Last DHCPv6**

Last known IPv6 address assigned by DHCPv6.

**Last DHCPv6 Lease**

Lease time of last known DHCPv6 address.

This page intentionally left blank

## 9 Configuring Auxiliary Devices



With Vertiv™ Liebert® iCOM™, you can manage and control many devices that work with your thermal-management unit(s).

### 9.1 Power Monitoring

Up to six power meters may be connected to each cooling unit. Power meters are factory programmed to monitor individual components or whole cooling units. For efficient data-center control, power meters provide monitoring of:

- Connection status
- Input under voltage
- Input RMS voltage leg to leg and leg to ground
- Input current per phase
- Energy consumption in kilowatt hours
- Instantaneous power in watts
- Power consumption

#### To Setup Power Monitoring

1. Touch  , then  > *Auxiliary Device Setup* > *Modbus Devices* > *Power Meters* > *Device X* (where X is the device number). The DEVICE X panel opens.
2. Adjust the power meter settings and touch Save. The power monitoring settings are saved.

**NOTE:** Depending on the type of thermal management unit, included components, and control settings of your system, all of the options listed may not be available on your Vertiv™ Liebert® iCOM™ display.

#### 9.1.1 Power Monitoring Device Options

##### Address

Modbus address for the power meter.

##### Connection Status

Read only. The connection status of the Modbus. Valid values:

- 0: Off
- 1: Connected
- 2: Unknown
- 3: Comm Error
- 4: Disconnect
- 5: Cfg Error

##### Device Enable

Enables/disables the Modbus power meter.

**Device X**

Editable field to describe the device.

**SysType**

Read-only. The type of feedback from the power meter. Valid values are:



- 0: 3Ph+N
- 1: 1Ph+N
- 2: 2Ph+N
- 3: 3Ph

**Type**

Read-only. The type of power meter.

## 9.2 Fluid Temperature Monitoring

Up to two supply and two return sensors may be connected to each cooling unit to monitor local and remote fluid temperature differential. A 2T sensor monitors fluid temperature (two 2T sensors on dual circuit units).

1. Touch  , then  > *Auxiliary Device Setup* > *Sensors* > *Fluid Sensors* > *Fluid 2T Sensor*. The SENSOR PROPERTIES panel opens.
2. Adjust the temperature offset, and touch *Save*. The fluid temperature sensor settings are saved.

**NOTE:** Depending on the type of thermal management unit, included components, and control settings of your system, all of the options listed may not be available on your Vertiv™ Liebert® iCOM™ display.

### 9.2.1 Fluid Sensor options

**Current Fluid Temperature**

Actual temperature reading.

**Fluid Sensor Type**

Type of sensor connected. Options are:

- 2T
- Dual 2T

**Fluid Temperature Offset**

Correction (calibration) value added to the fluid temperature reading. Used in the event that the fluid temperature sensor readings are incorrect.

- May be a positive or negative value.





## 9.3 Configuring Analog Input Devices

1. Touch , then  > *Auxiliary Device Setup* > *Analog Input*.  
The ANALOG INPUTS and ANALOG INPUT PROPERTIES panels open.

**NOTE: Depending on the type of thermal management unit, included components, and control settings of your system, all of the options listed may not be available on your Vertiv™ Liebert® iCOM™ display.**

2. Before you touch a specific analog input, the properties panel lists the inputs along with their configuration status:
  - *Factory Std* indicates that the input is configured for a factory-installed component such as a pressure transducer.
  - *Not Config* indicates that the input is configurable.
3. Select the associated Analog Input number, define the configuration type to be used for the Analog Input, and select the Input Range. Selectable options include 0-5V, 0-10V, and 4-20mA.

**NOTE: Up is on, down is off on the DIP switch. Switches 9 and 10 are not used.**

On Liebert® iCOM™, touch , then  > *Auxiliary Device Setup* > *Analog Input* > *Customer Analog Inputs*, then touch an Analog Input.  
The ANALOG INPUT PROPERTIES for that device displays.

4. Select the configuration and touch Save. The analog input is configured.



**NOTE: The Airflow, Static Pressure and Fluid Flow analog input settings configure factory options and require special instruction. Contact Vertiv™ Technical Support at 1-800-543-2778, opt. 5.**

## 9.4 Wired Remote Sensors

Wired, remote, rack sensors can function as control sensors and subsequently, provide input individually at the unit level or at the system level for temperature control and teamwork functions.

Each wired remote rack sensor has two thermistors/probes. In Individual Sensor mode, the higher temperature reading or the average temperature reading of the two probes can be used. In Unit Sensors mode, some or all of the rack sensor's temperature readings are considered for higher (maximum) or average calculation. For example, setting three sensors as control and average for unit mode, averages the three highest temperature readings.

At the system level, using a U2U network, the same maximum or average calculations can be based on readings from all of the sensors in all of the units in group (including those in standby) using Teamwork. See [Teamwork Modes](#) on page 101.

1. Touch , then  > *Auxiliary Device Setup* > *Sensors* > *Wired Remote Sensors* > *Setup*. The set-up SENSOR PROPERTIES panel opens.
2. Adjust the settings for the cooling units sensor array, and touch Save.  
[Wired Remote Sensor Setup Options](#) on the next page, describes the setting options.
3. Touch a specific sensor. The SENSOR PROPERTIES for that sensor open.

**NOTE: The sensor number listed corresponds to the DIP switch assignment of the sensor made during installation.**

4. Touch *Name*, and use the keyboard to give the sensor a descriptive name.

**NOTE: This is the name displayed on the REMOTE SENSORS panel for non-service users.**

5. Refer to the [Wired Remote Sensor Sensor Property Options](#) on the facing page to adjust the remaining settings, and touch *Save*. The wired-remote sensors for the cooling unit are configured.

## 9.4.1 Wired Remote Sensor Setup Options

### Average Rack Temp

Calculated average of temperature readings from the control sensors.

### Individual Remote Sensors Mode

When controlling at the sensor level, selects the method of using the readings from the two temperature thermistors (probes) on the sensor. Options are:

- Maximum: Use the highest temperature reading of the two thermistors.
- Average: Use the average of the readings from the two thermistors.

### Max Rack Temp

Highest temperature reading from the unit remote sensors.

### REM Sensors Set to Control

Number of sensors set to control.

### Unit Remote Sensors Mode

When controlling at the unit level, selects the method of using the inlet rack temperature readings from the control sensors to control fan speed. Options are:

- Maximum: Use the highest temperature reading of the sensors set to Control.
- Average: Use the average of the readings from the sensors set to Control and included in AVG.

### Unit Remote Sensors Included in AVG

When Unit Remote Sensors Mode is *Average*, selects the number of sensors used to calculate the average temperature.

- If the number selected is smaller than the number of REM Sensors set to Control, only the highest readings are used for the calculation.

**NOTE:** Depending on the type of thermal management unit, included components, and control settings of your system, all of the options listed may not be available on your Vertiv™ Liebert® iCOM™ display.

## 9.4.2 Wired Remote Sensor Sensor Property Options

### Function

Sets the function of the sensor when Unit Remote Sensors Mode is enabled.

- Disable: Sensor readings are ignored.
- Reference: Sensor readings are considered for Max Rack Temp, but are not used in maximum/average calculations.
- Control: Sensor readings are used in maximum/average calculations.

### Left Lead Current Value

Current reading of the left sensor probe. The left probe is always a temperature reading.

### Left Lead Offset

Correction (calibration) value added to the reading. Used in the event that the sensor reading is incorrect.

- May be a positive or negative value.

### Name

Custom, descriptive name to assist in identifying the sensor's location/function in the facility, for example, the name of the rack on which it is installed. The name is limited to:

- Up to 4 alphanumeric characters in length.
- Upper and lower case characters.
- These special characters: & \* / . + - : @ \.

### Right Lead Current Value

Current reading of the right sensor probe. May be a temperature or humidity reading, depending on the connected sensor.

### Right Lead Offset

Correction (calibration) value added to the reading. Used in the event that the sensor reading is incorrect.

- May be a positive or negative value.

## 9.5 Supply Sensors

When the supply air sensor is set as the control sensor for temperature, additional supply air configuration parameters (valve pulse, cooling filters and return compensation) can be used to enhance the supply air control.

The valve pulse and cooling filter timer can be adjusted to prevent oscillation around the supply setpoint and still allow for rapid cooling-capacity adjustments to compensate for heat load changes. Contact Vertiv™ technical support for adjustments.

**NOTE: Supply control air temperature sensors are required to use Optimized Aisle Teamwork (mode 3).**

**NOTE: On units equipped with a 3P actuator type valve, response can be improved by using the feedback signal.**

# 10 Administering Firmware, Settings and Security

## 10.1 Vertiv™ Liebert® iCOM™ Firmware Upgrades

**NOTE:** The Liebert® iCOM™ Service Tool (iST) is required to update control board firmware. Contact technical support at 1-800-543-2778, opt. 5 for information on control board updates.

### 10.1.1 Compatibility with Earlier Versions of Vertiv™ Liebert® iCOM™

Versions of Liebert® iCOM™ control firmware PA2.05.31R are incompatible with earlier firmware versions PA1.XX.XXXSTD.

The firmware versions PA2.05.31R and later cannot communicate with earlier versions. The Vertiv™ Liebert® DSE and Vertiv™ Liebert® PDX/PCW will not operate with PA1.XX.XXXSTD installed.

Contact your Vertiv representative to upgrade firmware.

### 10.1.2 Updating Vertiv™ Liebert® iCOM™ Control Board Firmware

The FIRMWARE UPGRADE panel shows the firmware version of the control board of the cooling unit. It also includes settings to use while performing the upgrade.

**NOTE:** Only personnel who have completed Vertiv training should perform a control board update. The Liebert® iCOM™ Service Tool (iST) is required to update control board firmware. Contact technical support at 1-800-543-2778, opt. 5 for information on control board updates.



1. Save the Liebert® iCOM™ software to a USB flash drive formatted with a FAT32 file system.
  - Make sure that the file-name extension is all lower case. For example, *.xpb* not *.XBP*.
  - Remove all other files with the *.xpb* extension from the flash drive.
2. At the Liebert® iCOM™ control:
  - Touch , then  > *Backup & Security* > *Firmware Upgrade*. The FIRMWARE UPGRADE panel opens.
  - Make sure the *Lock for Upgrade*, is selected.
  - Refer to [Control Board Firmware Upgrade Options](#) on the next page, for the reset and retain options.
3. On the Liebert® iCOM™ control board:
  - Insert the flash drive into the P76 USB port. After a few seconds, the DS25 LED lights up green.
  - P75 does not work for firmware upgrade.
  - To continue with the upgrade, press the S3 button near the LED within 15 seconds. The LED blinks blue to indicate that the upgrade has commenced. When the upgrade completes, the LED blinks fast green, and the board reboots with the new firmware.
4. Remove the USB flash drive after the board reboots.

Figure 10.1 P76, S3 and DS25 LED on the Board



Item	Description
1	P76 port
2	DS25 LED
3	S3 button

## Control Board Firmware Upgrade Options

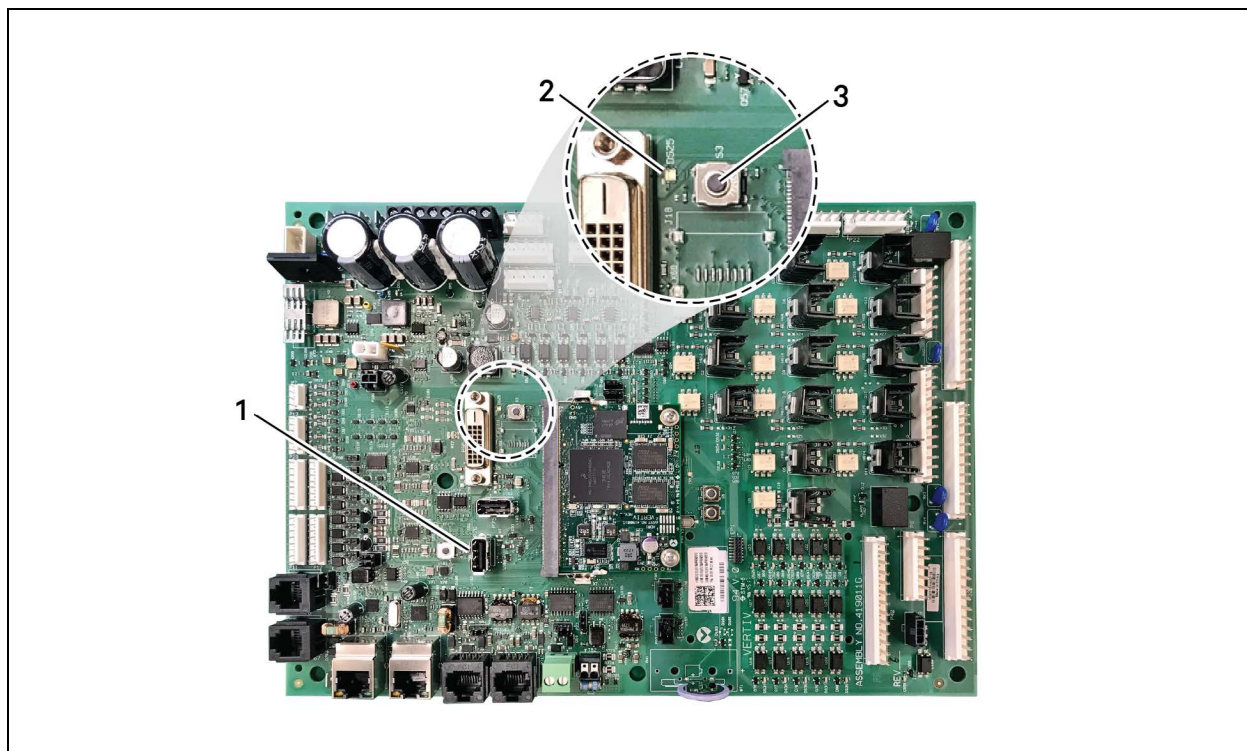
### Lock for Upgrade

When selected, the unit is locked for a firmware upgrade.

### Reset to Default Configuration

When selected, the unit is reset to the factory-default configuration during the upgrade

### Retain Network Configuration

When selected, the current network settings and options are retained while all other settings are reset to the factory default configuration.

### 10.1.3 Reverting to Firmware in Dormant Partition

The Vertiv™ Liebert® iCOM™ control board holds firmware in two partitions:

- The active partition holds the currently running firmware.
- The dormant partition holds the previously installed firmware.

Upon firmware upgrade, the new firmware writes to the dormant partition, which switches to the active partition when the upgrade is complete. If needed, you can revert to the previously installed version that is now in the dormant partition while the board boots after the upgrade.



To return to pre-upgrade firmware:

1. At boot, watch for the DS25 LED to flash red then blue for a second or two, and after it flashes red then blue, press-and-hold S3 for six to 10 seconds until DS25 lights solid red then release. **Figure 10.1** on the previous page, shows DS25 and S3 on the board.
2. Upon releasing S3, DS25 blinks for three seconds, and you must press and release S3 during that 3 seconds. If completed correctly, DS25 lights solid green and the board is reverted to the pre-upgrade firmware in the dormant partition. If incorrect, DS25 is not lit and the board boots normally.

**NOTE:** Use these steps to switch between active/dormant partitions (current/previous firmware) as needed. The switch can only be initiated right after a boot of the system, so power-off the unit, wait five seconds, and power on the unit, then start at step 1 above, as the system boots.

## 10.2 Backing Up and Restoring Control Board Settings

Vertiv™ Liebert® iCOM™ settings may be saved to a local disk or USB drive, and the saved files may be imported to restore Liebert® iCOM™ if it is replaced or if a problem occurs and to transfer settings to another Liebert® iCOM™.

1. Touch , then  > *Backup & Security* > *Control Backup/Restore*. The BACKUP & RESTORE panel opens.
2. Touch the *Action Type* drop-down, and select the action to perform.
3. Select the location, site, and system to save back-up files or load restore/replicate files, see [Control Board Back Up and Restore Options](#) below, for descriptions.

**NOTE:** USB drives are automatically detected and displayed as options for Location selection.

4. Touch the action button in the lower-right corner. A notification indicates that the back up/restore/replicate is complete.
5. Remove the USB drive from the port.

### 10.2.1 Control Board Back Up and Restore Options

#### Action Type

Selects the back up or restore function. Options are:

- **Back up:** Saves a copy of the settings in a file named with the IP address of the Liebert® iCOM™ control board. Use a backup file to restore the unit settings in the event of a failure.
- **Replicate:** Loads only the configsafe files (general settings/setpoints) from a back-up file from another system.
- **Restore:** Loads a backup configuration from a previously saved backup file. For example, when a control board fails and must be replaced, you can load the configuration from a backup of the failed board.

**Location**

Indicates the port to which the USB drive is connected.

**Site**

Indicates the folder you created on the USB drive to which the back up system file is saved.

**System**

The back up file named with the IP address of the control board from which it was saved.

**10.3 Managing Access Permission and Passwords****NOTICE**

Risk of loss of access to Vertiv™ Liebert® iCOM™ can cause operational problems.



When a password is changed, make sure you record the new password and inform authorized users. If problems arise, passwords can be reset by Vertiv Technical Support, visit <https://www.vertiv.com/en-us/support/>.

Two four digit passwords provide two levels of permission to access Liebert® iCOM™ menus and are set with factory-default values. You can change the value of each password so that only those provided with the current password may access the menus that it unlocks.

The factory-default password for user and service login are:

- Default User password: 1490
- Default Service password: 5010

**NOTE: To change the password, you must use the Service password currently assigned to unlock the Service menu.**

1. Touch , then  > *Backup & Security* > *Manage Permissions*. The MANAGE PINS panel opens.
2. Touch the role to change, then touch the *Value* field for the password to change. The keypad opens.
3. Type a new four digit/character password, then touch , and touch *Save*. The password is saved.
  - Touch *Cancel* to discard the change.



# 11 Performing Diagnostics

**NOTE:** Depending on the type of thermal management unit, included components, and control settings of your system, all of the options listed may not be available on your Vertiv™ Liebert® iCOM™ display.

## 11.1 Cooling Unit Status LED

Just below the Vertiv™ Liebert® iCOM™ touchscreen display is an LED that changes color and flashes on and off to indicate cooling unit status. See **Table 11.1** below, for the LED colors and meanings.

**Table 11.1 Cooling Unit LED Colors and State Meanings**

State	Color(s)	Meaning
Solid	Green	Powered on and operating.
Solid	Amber	In diagnostic/service mode or powered-off.
Solid	Red	Active warning or alarm present and acknowledged.
Flashing	Amber/Green	In sleep or U2U stand-by mode and available to operate.
Flashing	Red/Green	Operating with an active warning or alarm.
Flashing	Amber/Red	Shut down (not operating) because of an unacknowledged alarm.
Flashing	Red	Active warning or alarm present but unacknowledged.
Flashing	Blue	Liebert® iCOM™ display is starting up or updating Liebert® iCOM™ firmware.



## 11.2 Enabling Manual Mode for Diagnostics

Use manual mode to test components, validate operation, and evaluate performance.



**NOTE:** When manual mode is enabled, the cooling unit does not operate normally:

- Fan operation depends on the diagnostic category in use.
- Safety routines will prevent the use of some diagnostic features.
- Active alarms may prevent some the use of some diagnostic functions.
- In most cases, all components are turned off.



**NOTE:** When manual mode is disabled, all components and the cooling unit return to normal operation. See **Disabling Diagnostics Manual Mode** on the next page. Manual mode will timeout after 30 minutes of inactivity and normal operation resumes.

1. Touch , then  > *Diagnostic/Service* > *Diagnostics* > *Manual Mode* in the Category list. The MANUAL MODE panel displays.
2. Touch the *Enable* check box in the upper-right of the *MANUAL MODE* panel. The MANUAL MODE confirmation dialog opens.
3. Touch *OK* to enable manual mode. Enable is checked and manual control for diagnostics enabled.
  - Touch *Cancel* to close the dialog and manual mode remains disabled.

### 11.2.1 Disabling Diagnostics Manual Mode

1. Touch , then  > *Diagnostic/Service* > *Diagnostics* > *Manual Mode* in the Category list. The MANUAL MODE panel displays.
2. Remove the check mark from the *Enable* box by touching it. Manual mode is disabled.

### 11.3 Diagnosing Evaporator Fan Issues

1. Touch , then  > *Diagnostic/Service* > *Diagnostics* > *Evaporator Fan* in the Category list. The EVAPORATOR FAN panel displays.
2. Refer to [Diagnostics—Evaporator Fan Options](#) below, for descriptions of diagnostic options.

**NOTE:** Depending on the type of thermal management unit, included components, and control settings of your system, all of the options listed may not be available on your Vertiv™ Liebert® iCOM™ display.

#### 11.3.1 Diagnostics—Evaporator Fan Options

##### Analog Output 1 – 4

0V to 10V analog output that drives the speed of the evaporator fan. Typically, the evaporator fan is Analog Output 1 by default.

##### Analog Output 1 Selection

Var SpeedDrive.

##### Fan Speed

Current speed of fan.

##### Motor Overload/EC Fan Fault

Indicates status of input feedback. If cooling unit has EC fans, it is the EC-fan fault input. If cooling unit has standard fans (no variable speed drive), it is the motor overload input.

##### Motors

Enables/disables fan motor during manual/diagnostic mode.

##### Status Airflow Loss

Indicates if the status of the Air Safety switch is open or closed.



##### Status Filter

Status of the air filter.

##### Status Remote Shutdown

Indicates whether remote shutdown is on or off.

## 11.4 Diagnosing Compressor Circuit Issues

1. Touch , then  > *Diagnostic/Service* > *Diagnostics* > *Compressor Circuit N* (where “N” is the circuit number) in the Category list. The COMPRESSOR CIRCUIT panel displays.
2. Refer to [Diagnostics—Compressor Circuit Options](#) below, for descriptions of diagnostic options.

**NOTE:** Depending on the type of thermal management unit, included components, and control settings of your system, all of the options listed may not be available on your Vertiv™ Liebert® iCOM™ display.

### 11.4.1 Diagnostics—Compressor Circuit Options

#### Compressor Capacity

Enables/disables compressor capacity during manual/diagnostics mode.

#### Compressor Freeze Protection

Indicates whether freeze protection influences compressor capacity (on) or not (off), based on low pressure values.

#### Compressor Mode

Selects compressor operation during manual/diagnostics mode. Options are:

- 0: Run (normal operation)
- 1: Evacuate
- 2: Charge

#### Compressor Overload

Compress overload status.

#### Compressor State

Compressor status, on or off.

#### Fan Freeze Protection

Indicates whether freeze protection influences fan speed (on) or not (off), based on low-pressure values.

#### High Pressure Alarm Code

Code of high pressure alarm. To address the alarm condition, see [Resetting High Pressure Alarm Code](#) on the next page .

- 0: Okay
- Non-zero: High head pressure situation.

#### High Pressure Status

Status of compressor’s high pressure switch.

## Liquid Line Solenoid Valve

Enables/disables the valve during manual/diagnostics mode.

## Low Pressure Alarm Code

Code of low-pressure alarm. To address the alarm condition, see [Resetting Low Pressure Alarm Code](#) below .

- 0: Okay.
- Non-zero: Low suction pressure condition.

## Low Pressure Status

Status of compressor's low pressure switch.

## Pump Down Failure Counter

Number of pump down failure events.



## Status HT1

Count of times compressor is powered off for high scroll temperature.

### 11.4.2 Resetting High Pressure Alarm Code

When a high pressure problem has caused a compressor to lock off, resetting the High Pressure Alarm Code to zero unlocks the compressor for operation.

**NOTE: Cycling main power of the cooling unit will also unlock the compressor.**

1. Touch , then  > *Diagnostic/Service* > *Diagnostics* > *Compressor Circuit N* in the Category list (where "N" is the circuit number).
2. On the COMPRESSOR CIRCUIT panel, touch *Set to Zero* next to High Pressure Alarm Code, then touch *Save*. The code is reset and the compressor can now operate.



### 11.4.3 Resetting Low Pressure Alarm Code

When a low pressure problem has caused a compressor to lock off, resetting the Low Pressure Alarm Code to zero unlocks the compressor for operation.



**NOTE: Cycling main power of the cooling unit will also unlock the compressor.**

1. On the Service menu, touch *Diagnostic/Service* > *Diagnostics*. The DIAGNOSTICS panel opens.
2. Touch *Compressor Circuit N* in the Category list (where "N" is the circuit number).
3. On the COMPRESSOR CIRCUIT panel, touch *Set to Zero* next to Low Pressure Alarm Code, then touch *Save*. The code is reset and the compressor can now operate.

## 11.4.4 Resetting High Temperature Alarm Counter

1. Touch , then  > *Diagnostic/Service* > *Diagnostics* > *Compressor Circuit N* in the Category list (where “N” is the circuit number).
2. On the COMPRESSOR CIRCUIT panel, touch *Set to Zero* next to High Temperature Alarm Counter, then touch *Save*. The code is reset and the compressor can now operate.

## 11.5 Diagnosing Electronic Expansion Valve Issues

1. Touch , then  > *Diagnostic/Service* > *Diagnostics* > *Electronic Expansion Valve N* in the Category list. The ELECTRONIC EXPANSION VALVE panel displays.
2. Refer to [Diagnostics—Electronic Expansion Valve Options](#) below for descriptions of diagnostic options.

**NOTE:** Depending on the type of thermal management unit, included components, and control settings of your system, all of the options listed may not be available on your Vertiv™ Liebert® iCOM™ display.

### 11.5.1 Diagnostics—Electronic Expansion Valve Options

#### Current SH Setpoint

Setpoint for superheat.

#### EEV Batt Fail Counter C1

Number of battery test failures for the valve control board. To address the alarm condition, see [Resetting EEV Battery Failure Counter](#) on the next page.

#### Firmware Version

Current firmware data.

#### Manual Valve Control

Sets the valve open percentage during manual/diagnostics mode.

#### Manual Valve Control Enabled

Enables/disables manual control of the valve in manual/diagnostics mode.

#### Saturation Suction Temp

Saturated suction temperature of the refrigeration circuit.

#### Status Battery

Status of the battery on the valve control board.

**Status EEV**

Current status of the valve control board.

**Suction Pressure**

Current pressure at valve.

**Suction Temp**

Suction temperature of the refrigeration circuit.



**Superheat**

Current superheat reading of the refrigeration circuit.



**Valve Opening**

Current percentage that valve is open.

**11.5.2 Resetting EEV Battery Failure Counter**

1. Touch , then  > *Diagnostic/Service* > *Diagnostics* > *Electronic Expansion Valve N* in the Category list.
2. On the ELECTRONIC EXPANSION VALVE panel, touch *Set to Zero* next to EEV Batt Fail Counter, then touch *Save*. The counter is reset.

**11.6 Diagnosing Vertiv™ Liebert® EconoPhase Issues**

1. Touch , then  > *Diagnostic/Service* > *Diagnostics* > *EconoPhase* in the Category list. The ECONOPHASE panel displays.
2. Refer to [Diagnostics—Vertiv™ Liebert® EconoPhase Options](#) below, for descriptions of diagnostic options.

**NOTE:** Depending on the type of thermal management unit, included components, and control settings of your system, all of the options listed may not be available on your Vertiv™ Liebert® iCOM™ display.

**11.6.1 Diagnostics—Vertiv™ Liebert® EconoPhase Options****Pump Board N Firmware**

Firmware version of the pump control board, where N is the pump number.

**Pump Board Test**

Runs a diagnostic test on the board.

**Pump N Diff Pressure**

Current differential-pressure reading, where N is the pump number.

## Pump N Inlet pressure

Current inlet-pressure reading, where N is the pump number.

## Pump N Outlet Pressure

Current outlet-pressure reading , where N is the pump number.



## Pump N Speed

Current pump speed, where N is the pump number.

## Pump N Test Results

Results of board test, where N is the pump number.

## 11.7 Diagnosing Reheat Issues

1. Touch , then  > *Diagnostic/Service* > *Diagnostics* > *Reheat* in the Category list. The REHEAT panel displays.
2. Refer to [Diagnostics—Reheat Options](#) below , for descriptions of diagnostic options.

**NOTE:** Depending on the type of thermal management unit, included components, and control settings of your system, all of the options listed may not be available on your Vertiv™ Liebert® iCOM™ display.

### 11.7.1 Diagnostics—Reheat Options



#### Analog Output 1 – 4

0V to 10V analog outputs that operate reheat.

#### Electric Heat N

Enables/Disables heaters in manual/diagnostic mode. (Where N = electric heat number.).

## 11.8 Diagnosing Humidifier Issues

1. Touch , then  > *Diagnostic/Service* > *Diagnostics* > *Humidifier* in the Category list. The HUMIDIFIER panel displays.
2. Refer to [Diagnostics—Humidifier Options](#) on the next page , for descriptions of diagnostic options.

**NOTE:** Depending on the type of thermal management unit, included components, and control settings of your system, all of the options listed may not be available on your iCOM™ display.

## 11.8.1 Diagnostics—Humidifier Options

### Hum Cond Protect < 53°F / 11.6°C

Status of low temperature protection.

### Hum Cond Protect > 55% RH

Status of high relative humidity protection.

### Humidifier

Enables/disables humidification in manual/diagnostic mode.

### Local Hum PI

Current humidity PI percentage.

### Status Humidifier Problem

Current status of the humidifier. OK indicates that the status is good.



### Supply Humidity

Current supply air humidity.

### Supply Temperature

Current supply air temperature.

## 11.9 Diagnosing Digital Output Issues

1. Touch  , then  > *Diagnostic/Service* > *Diagnostics* > *Digital Outputs* in the Category list. The DIGITAL OUTPUTS panel displays.
2. Refer to [Diagnostics—Digital Output Options](#) on the facing page for descriptions of diagnostic options.

**NOTE:** Depending on the type of thermal management unit, included components, and control settings of your system, all of the options listed may not be available on your Vertiv™ Liebert® iCOM™ display.



## 11.9.1 Diagnostics—Digital Output Options

### Alarm Relay

Enables/disables alarms during manual/diagnostic mode.



### K11 Relay

Enables/disables warnings during manual/diagnostic mode.

### Q15 Output State

Enables/disables Q15 output during manual/diagnostic mode.

## 11.10 Diagnosing Analog Output Issues

1. Touch , then  > *Diagnostic/Service* > *Diagnostics* > *Analog Outputs* in the Category list. The ANALOG OUTPUTS panel displays.
2. Refer to [Diagnostics—Analog Output Options](#) below, for descriptions of diagnostic options.



**NOTE:** Depending on the type of thermal management unit, included components, and control settings of your system, all of the options listed may not be available on your iCOM™ display.

### 11.10.1 Diagnostics—Analog Output Options

#### Analog Output N

Controls analog outputs during manual/diagnostic mode. (*Where N is the analog output number.*)

## 11.11 Diagnosing Customer Input Issues

1. Touch , then  > *Diagnostic/Service* > *Diagnostics* > *Customer Inputs* in the Category list. The CUSTOMER INPUTS panel displays.
2. Refer to [Diagnostics—Customer Input Options](#) below, for descriptions of diagnostic options.



**NOTE:** Depending on the type of thermal management unit, included components, and control settings of your system, all of the options listed may not be available on your Vertiv™ Liebert® iCOM™ display.

### 11.11.1 Diagnostics—Customer Input Options

#### Input N

Status and description of customer-input sensors. (*Where N is the input number.*)

## 11.12 Diagnosing Water Leak Detection Issues

1. Touch , then  > *Diagnostic/Service* > *Diagnostics* > *Water Detection* in the Category list. The WATER DETECTION panel displays.
2. Refer to [Diagnostics—Water Leak Detection Options](#) below , for descriptions of diagnostic options.

**NOTE:** Depending on the type of thermal management unit, included components, and control settings of your system, all of the options listed may not be available on your Vertiv™ Liebert® iCOM™ display.

### 11.12.1 Diagnostics—Water Leak Detection Options

#### LWD Value



Current percentage of resistance measured from the leakage water detection sensor. See [Setting Water Leak Detector Options](#) on page 67 . Range of values across:

- 0%: Maximum resistance, sensor is dry.
- 100%: Minimum resistance, sensor is wet.

# 12 Customizing the Vertiv™ Liebert® iCOM™ Display

## 12.1 Setting General Display Properties

**NOTE:** You must be logged in to adjust the settings. See [Powering On the Vertiv™ Liebert® iCOM™ and Logging In/Unlocking Controls](#) on page 6 .

1. Touch , then  > *Display Options* > *Display Properties*.  
The DISPLAY PROPERTIES panel opens.
2. Touch a value to select the setting from the drop-down list
3. Touch *Save* to save the property settings.
  - Touch *Cancel* to discard changes.

### 12.1.1 Unit Display Options

#### Alarm Buzzer Pattern

Selects or disables the audible alarm notification. See [Enabling the Audible Alarm Notification](#) on page 92 .

#### Allow System On/Off

Enables/disables powering on/off the entire system of networked units from the Vertiv™ Liebert® iCOM™ display.

#### Backlight Brightness

Selects the brightness of the display back light.

#### Inactivity Timer

Time to elapse before display locks and dims.

#### Language

Selects the display language.

#### LED Brightness

Percentage brightness of the display.

#### Measurement System

Selects the units of measurement. Options are:

- Imperial (°F)
- Metric (°C)

## Skin

Selects the color/background format of the user interface. Options are:

- Dark blue
- White
- Dark grey

## Touch Beep

Enable/disable sound when display is touched.

## Touch Shockwave

Enable/disable visual shockwave when display is touched.

## Turn Unit On/Off without Password

When enabled, a Power On/Off button displays in the upper-right corner of the Vertiv™ Liebert® iCOM™ main display so personnel can turn the unit on or off with out logging in and accessing the User/Service menus.



# 12.2 Customizing Main Display Views

The default Vertiv™ Liebert® iCOM™ display view is essentially a layout of two panels, one with status content and the other with alarms content. You can create custom display views by adding, changing, moving, and resizing the content objects.

**NOTE: You must be logged in to customize the view. See [Powering On the Vertiv™ Liebert® iCOM™ and Logging In/Unlocking Controls](#) on page 6 .**

## 12.2.1 Moving Content

You can drag and drop content objects anywhere you like on the main display.

1. Touch , then .
2. Touch  in the upper-right corner of the display and just below the control header.
3. Touch an object to select it (highlighted green), and drag it to the new location.

## 12.2.2 Resizing Content

You can resize content objects on the main display.



1. Touch , then .
2. Touch  in the upper-right corner of the display and just below the control header.
3. Touch an object to select it (highlighted green), touch and drag a handle to re-size the object, see [Figure 12.1](#) on the facing page .





Figure 12.1 Add/Remove Content Icons and Resizing Handles

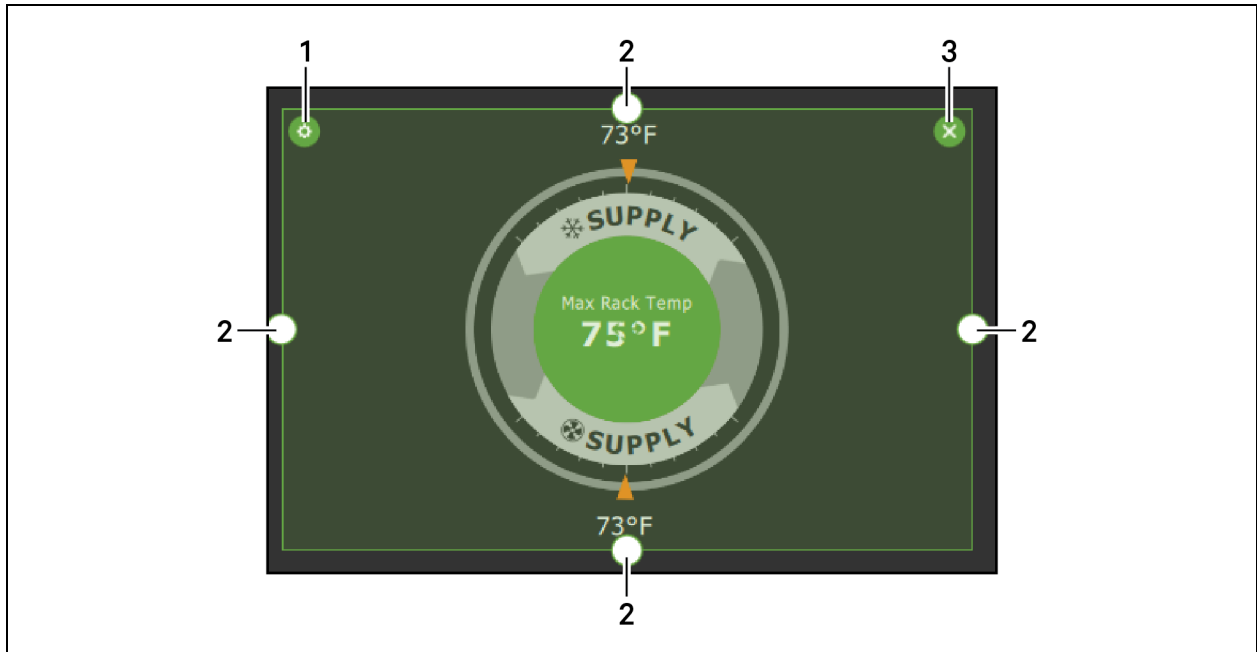

Item	Description
1	Content adjustment icon
2	Resizing handles
3	Remove content icon

### 12.2.3 Adding and Adjusting Content

You can add a variety of content to the main display.

1. Touch , then .
2. Touch  in the upper-right corner of the display and just below the control header, then touch . A menu of content options opens, described in [Table 12.1](#) on the next page.
3. Touch the Move icon next to the content and drag it onto the display, then use the re-size handles to adjust as needed.
4. To adjust the content object or the way it displays, touch , see [Figure 12.1](#) above.

**Table 12.1 Main Use Display Content Options**





Content	Description
Separator	Separating line to place between content sections. You can adjust the thickness and orientation of the separator.
Dial	Status dial. You can select the sensor readings displayed in the center of the status dial when you touch to scroll through the readings.
Setpoint Readout	Displays the current reading of a connected sensor, for example: return temperature at 72°F.

**Table 12.1 Main Use Display Content Options (continued)**

Content	Description
Setpoint Bar	Displays a bar graph for a selected setpoint with customizable empty and full limits. For example, if a temperature setpoint bar is empty at 60°F and full at 80°F, and the reading is 70°, the graph will be filled half way.
Sensor Bar	For remote sensors only, functions the same as the setpoint bar, but only offers connected remote sensors, and displays the customer-assigned name of the sensor next to the graph.
Shortcut	Shortcut opens panels directly instead of browsing through menus. You can select the destination of the shortcut, whether or not an icon displays, and the size, label, and frame of the shortcut.
Alarms	Alarms panel. You can select whether or not the information may be exported.
Event Log	Event log panel. You can select whether or not the information may be exported.
Run Hours	Run hours panel. Summary of the component run hours and limits.
EconoPhase Diagram	Liebert® EconoPhase operating diagram.
EconoPhase Status	Compressor/Liebert® Econophase status bar. Indicates the operating mode and the percentage at which the component is operating.

## 12.2.4 Removing Content



You can easily remove content from the main display.

1. Touch , then .
2. Touch  in the upper-right corner of the display and just below the control header.
3. Touch an object to select it (highlighted green), then touch , see **Figure 12.1** on the previous page.

## 12.3 Customizing Parameter and Field Labels

You can customize header labels for parameters in the menus and you can customize field names.

**NOTE:** You can export labels for back up or to use a text editor to customize the labels. See [Exporting, Importing and Customizing Labels Using a Text Editor](#) on page 180.

1. Before going to the customization panel, use the search box and on-screen keyboard to find the label(s) that you want to customize. Once you know where they are, you'll be able to find them in the categories on the Customize Labels panel.
2. Touch , then  > *Display Options* > *Custom Labels*.  
The CUSTOM LABELS panel opens. The labels are divided into categories that represent the names of menus, sub-menus, and screen panels.
3. Locate the category that contains the label(s) to customize that you determined in step 1, and touch to expand it.

4. In the Custom Text column, touch the text box to edit, make changes and touch . See **Figure 12.2** below , for an example of changing the column names for Property and Value (in the Analog Inputs panel) to Input and Configuration.
  - Touch *Cancel* to discard the change.
5. When finished editing labels, make sure the Enable Custom Labels is selected (or your updates will not display), and touch *Save*. The label(s) are updated. **Figure 12.3** below , shows the Analog Input Properties panel with the custom labels that replaced Property and Value.

**Figure 12.2 Custom Text for the Analog Input Properties Labels**

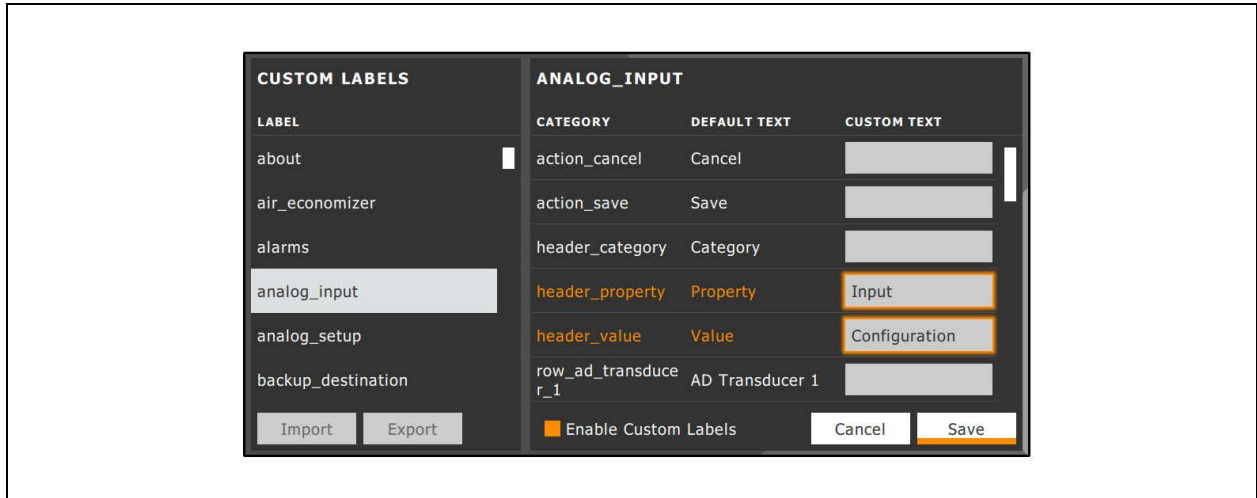

**Figure 12.3 Customized Label Text on Analog Input Properties Panel**

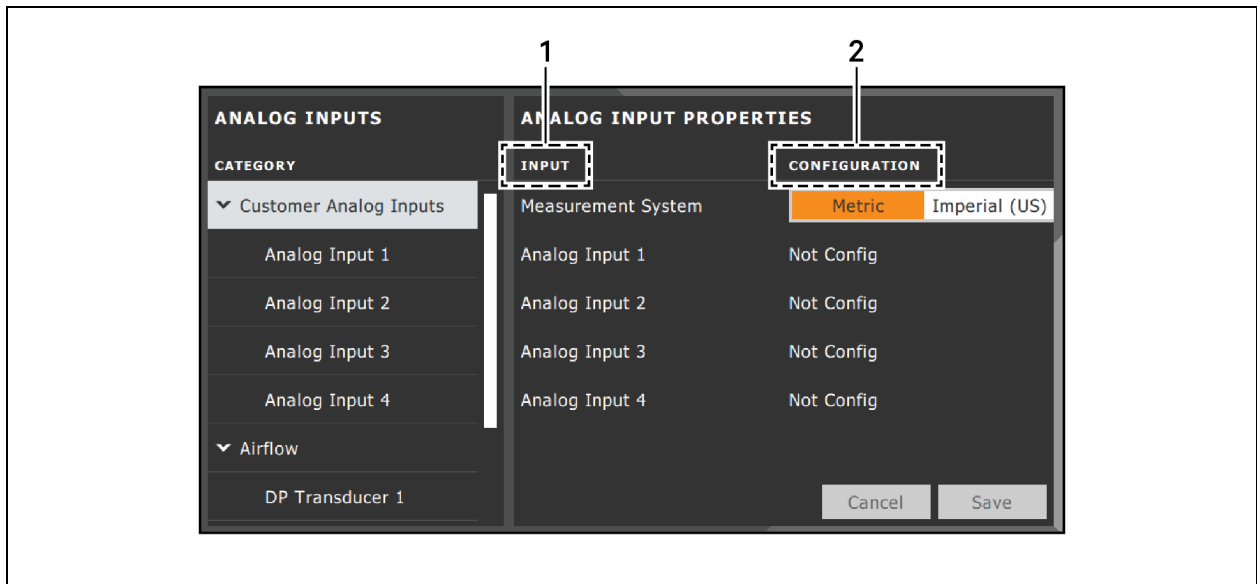

Item	Description
1	Former Parameter heading is now Input.
2	Former Value heading is now Configuration.

### 12.3.1 Exporting, Importing and Customizing Labels Using a Text Editor

You can export custom label settings to a text file for back up or to modify the labels using a text editor. The text file is exported and imported using a USB drive.

1. Insert a USB drive into an open USB port on the rear of the touchscreen display, then navigate to the Custom Labels panel and touch *Export*.  
The EXPORT FILE dialog opens, and the connected USB drive is automatically detected.
  - If you are prompted No USB devices are available, check the connection or try re-inserting the drive.
2. Touch *Name* and type a descriptive name for the file, then touch *Go*.
3. Touch *Export* and wait at least 15 seconds, then you can remove the USB drive.
4. Insert the USB drive into a PC or laptop and locate the file, which is named with the Name you entered and the extension cl.txt. For example, if you named your export MyLabels, the file will be MyLabels.cl.txt.
5. Open the file in a text editor. The file contains all of the labels available for customization listed with the menu/panel on which the label is located, the label identifier, and an equal sign (=) as shown in the following example:

**NOTE: You must use an editor that interprets Linux line endings, otherwise all of the lines will run together. For example, Microsoft WordPad will interpret the Linux line endings, but Microsoft Notepad will not.**

```
analog_input/row_customer_analog_inputs=Unit A Inputs
analog_input_properties/header_property=Property
analog_input_properties/header_value=Value
```

6. To customize, type a new label name to the right of =, and save the text file.  
The following example will result in the same custom labels shown in **Figure 12.3** on the previous page .

```
analog_input/row_customer_analog_inputs=Unit A Inputs
analog_input_properties/header_property=Input
analog_input_properties/header_value=Configuration
```

7. Remove the USB drive with the updated/saved text file from the PC/laptop, insert it into an open USB port on the rear of the touchscreen display, then navigate to the Custom Labels panel and touch *Import*.
8. Locate the updated text file in the drop-down list, and touch *Import*.  
The dialog closes and the customizations display on the menus and panels that you updated.



## 13 Vertiv™ Liebert® iCOM™ Hardware Installation

Your unit includes the Liebert® iCOM™ controller. This section describes the installation of connections and cabling to fully utilize the Liebert® iCOM™ features.

### 13.1 Return Air Temperature/Humidity Sensor

The return temperature/humidity sensor is located in the unit return air section and is supplied on all Liebert® systems with Vertiv™ Liebert® iCOM™ controls. The assembly connects to plug connection P67 on the Liebert® iCOM™ internal control board on all Vertiv™ Liebert® CRV systems.

Troubleshooting is accomplished by observing a green LED located on the sensor internal control board. If the LED is solid green, the sensor is communicating properly with the Liebert® iCOM™ controller. If the LED is continuously flashing green, the sensor is not communicating properly and the P3 CANbus termination should be verified that it is properly terminated. No LED indicates the sensor does not have power present.

#### 13.1.1 P67: Return Air Temperature—Humidity Board

P67-1: CAN communication

P67-6: CAN communication

Figure 13.1 Standard Return Air Sensor

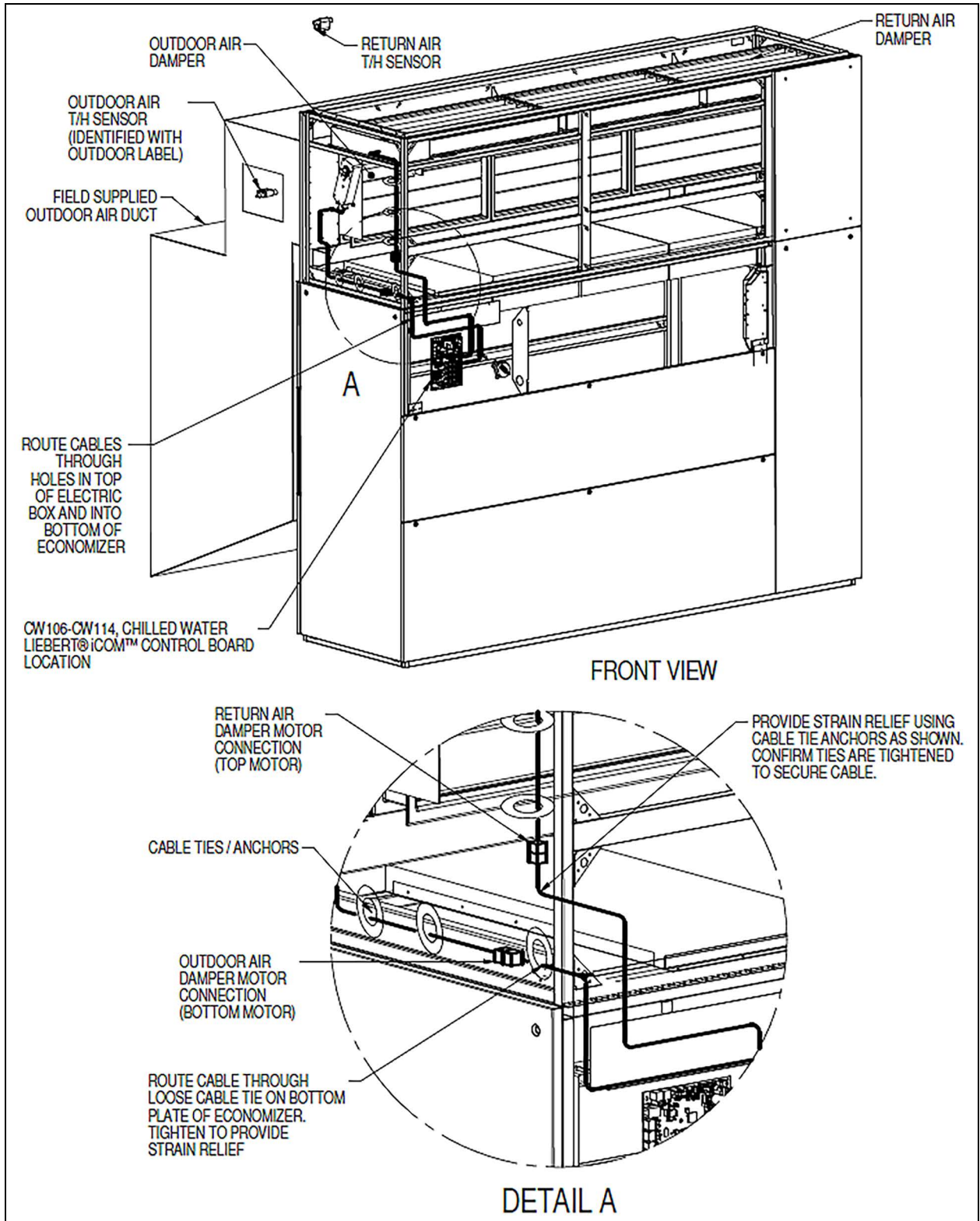

Figure 13.2 Optional Remote Sensor A, B, C



Table 13.1 Temperature/Humidity Sensor Dip Switch Settings

Sensor	Pos. #1	Pos. #2	Pos. #3	Pos. #4	Pos. #5	Pos. #6	Pos. #7	Pos. #8
Return T/H Sensor	Off	Off	Off	Off	Off	Off	Off	Off
Optional Sensor A	On	Off	Off	Off	On	Off	Off	Off
Optional Sensor B	Off	On	Off	Off	On	Off	Off	Off
Optional Sensor C	On	On	Off	Off	On	Off	Off	Off

Table 13.2 Temperature/Humidity Sensor Jumper Settings

Jumper Label	Type	Position
P2	BDM Header	*Open
P3	CANbus Termination	*Shunt on Pins 2 and 3
P4	Programming	*Open
E10-E13	Serial Port	*Open

\*Factory default positions and settings.

### 13.1.2 Jumper P3 CANbus Termination

The correct position of this jumper is dependent on your system configuration. If the sensor is physically the first or last node in the CANbus device loop, the jumper must be terminated or shunted across pins #2 and #3 (default position). If the sensor is a middle node in the CANbus device loop, the jumper must be unterminated or shunted across pins #1 and #2.

## 13.2 Installing Wired Remote Sensors

Up to 10 remote sensor modules, installed in the monitored racks and connected to the cooling unit, provide control and reference input to Vertiv™ Liebert® iCOM and building-management systems. Using remote, rack sensors combats cooling problems related to recirculation air, uneven rack loading, and air distribution.

The sensor array consists of 2T sensors that each have two temperature probes on a 6 ft. (1.8 m) probe-connection cable, **Figure 13.3** below, and requires several steps to prepare, connect, and begin monitoring the racks:

- Set DIP switches in each sensor.
- Terminate final sensor on CANbus link.
- Install sensors on racks.
- Install CANbus cabling between sensors.
- Connect CANbus cable to the cooling unit.
- Configure the sensors in Liebert® iCOM™.

**NOTE: The 2T sensor shown in Figure 13.3 below, may differ slightly for your system, depending on equipment installed.**

**Figure 13.3** 2T Sensor for Rack Monitoring



### 13.2.1 Setting DIP Switches and Labeling 2T Sensors

Tools required:

- Small, non-conductive tool to set switches.
- Small, Phillips head screw driver to open 2T housing.

Each sensor requires a unique address in the CANbus loop connected to the cooling unit. We recommend that you set the DIP switch sensor number setting to correspond to the sensor's location on the CANbus run. If settings are incorrect, the control will not operate properly.

**NOTE:** Sensors are connected in a daisy chain via CANbus cabling to the cooling unit control board. You can extend the sensor network (up to 10) by adding sensors to the end of the chain and adjusting the termination settings. Do not run individual wires from the sensors to the cooling unit.

1. Apply numbered stickers to the sensor housing that corresponds to the sensor's position in the chain.
2. Locate the DIP switch hole on the rear of the sensor housing, **Figure 13.4** below .

– or –

If the hole is not present, or the settings are difficult to make through the hole, remove the cover by removing the Phillips head screws (typically 3). See **Figure 13.4** below .

**NOTE:** Use the non-conductive DIP switch tool (included) or a similar tool to set switches. Do not insert any metal object into the sensor case.

**Figure 13.4** DIP Switch Opening/DIP Switches Inside of 2T Sensor

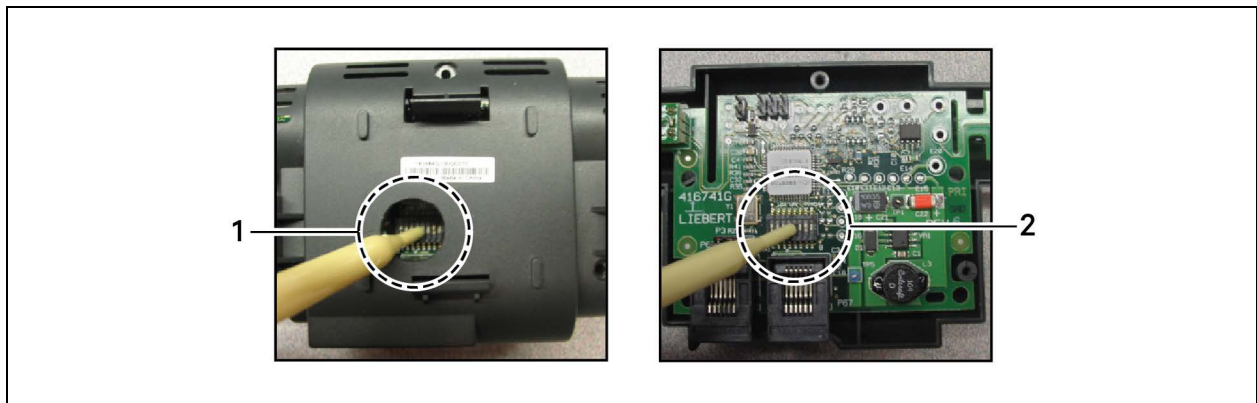

Item	Description
1	Hole in sensor housing
2	Cover removed

- Referring to **Table 13.3** below, and using the non-conductive tool, set the DIP switches for each sensor to its number in the chain (from sticker applied in step 1).

**Figure 13.5** below, shows a representation of the DIP switches.

- Confirm that the DIP switches are set correctly for each sensor, and replace the housing cover if necessary.

**Table 13.3 DIP Switch Settings for Wired Remote Sensors**

2T Sensor Number/Address	DIP Switch Position							
	1	2	3	4	5	6	7	8
1	Off	Off	On	Off	On	Off	Off	Off
2	On	Off	On	Off	On	Off	Off	Off
3	Off	On	On	Off	On	Off	Off	Off
4	On	On	On	Off	On	Off	Off	Off
5	Off	Off	Off	On	On	Off	Off	Off
6	On	Off	Off	On	On	Off	Off	Off
7	Off	On	Off	On	On	Off	Off	Off
8	On	On	Off	On	On	Off	Off	Off
9	Off	Off	On	On	On	Off	Off	Off
10	On	Off	On	On	On	Off	Off	Off

**NOTE:** Up is on, down is off on the DIP switch.

**Figure 13.5** DIP Switches in 2T Sensor

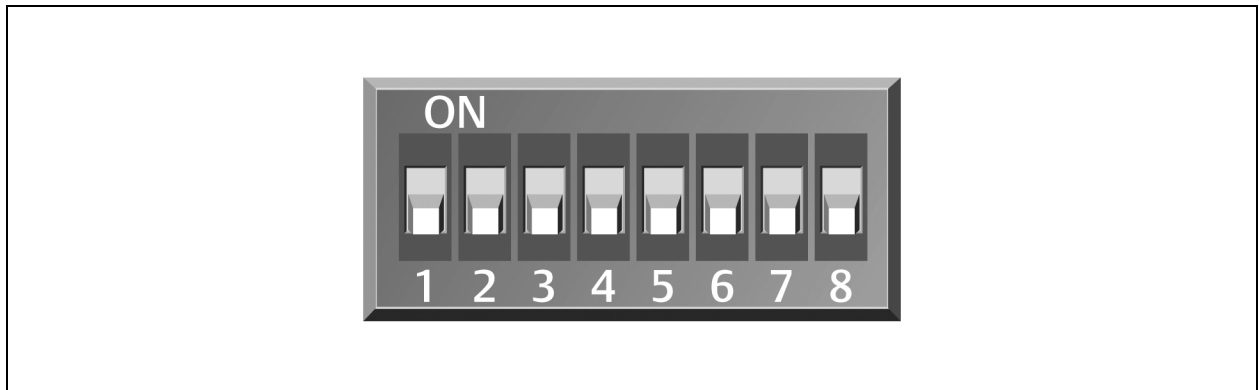

### 13.2.2 Terminating the Last Sensor on the CANbus link

The 2T sensor need not be installed in the numeric-order of their address/sensor number (although it may be easier for later maintenance). However, the last sensor in the chain must be terminated. All others must remain un-terminated. We also recommend that you make a record of the sensor numbers along with the name/number of the rack on which they are installed. **Figure 13.6** on the facing page, shows an example CANbus arrangement.

**NOTE:** To add sensors, unterminate final sensor, add sensors to the chain, and terminate the new final sensor.

Figure 13.6 Example Sensor CANbus Arrangement

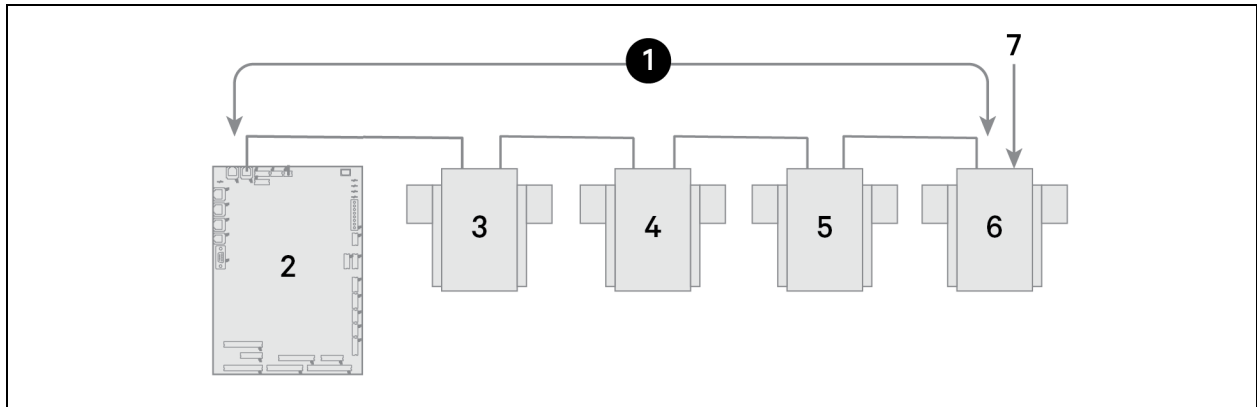

Item	Description
1	CANbus communication loop
2	Liebert® iCOM™ control board
3	2T sensor
4	2T sensor
5	2T sensor
6	2T sensor
7	Terminated sensor

To terminate the last sensor:

1. Locate the sensor that will be last on the network.

**NOTE:** The last sensor on the network will be the sensor with only one CAN cable after all sensors are connected to the CANbus network. See [Connect the CANbus Cable and Ground](#) on page 191.

2. Open the sensor's case by removing the Phillips head screws (typically 3) on the rear of the housing to access the jumper used for terminating.
3. Remove the black jumper from pins 1 and 2 on the P3 pin connector, and install it on pins 2 and 3 as shown in [Figure 13.7](#) on the next page.
4. Replace the sensor cover. The 2T sensor is terminated in the CANbus link.

Figure 13.7 Termination Jumper on 2T Circuit Board

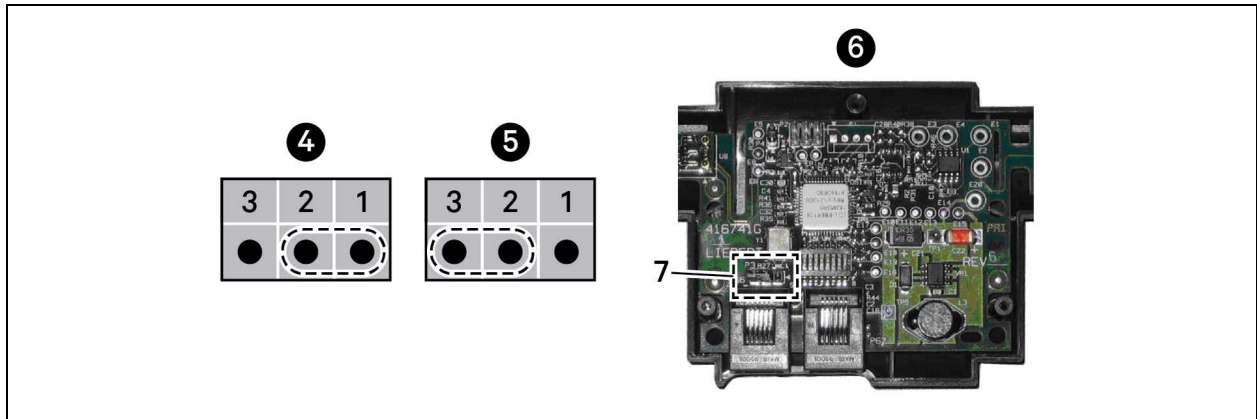

Item	Description
1	Position 1 (P3 jumper)
2	Position 2 (P3 jumper)
3	Position 3 (P3 jumper)
4	Unterminated
5	Terminated
6	Rear of sensor, cover removed
7	P3 termination jumper



### 13.2.3 Installing 2T Sensors in the Racks to Monitor







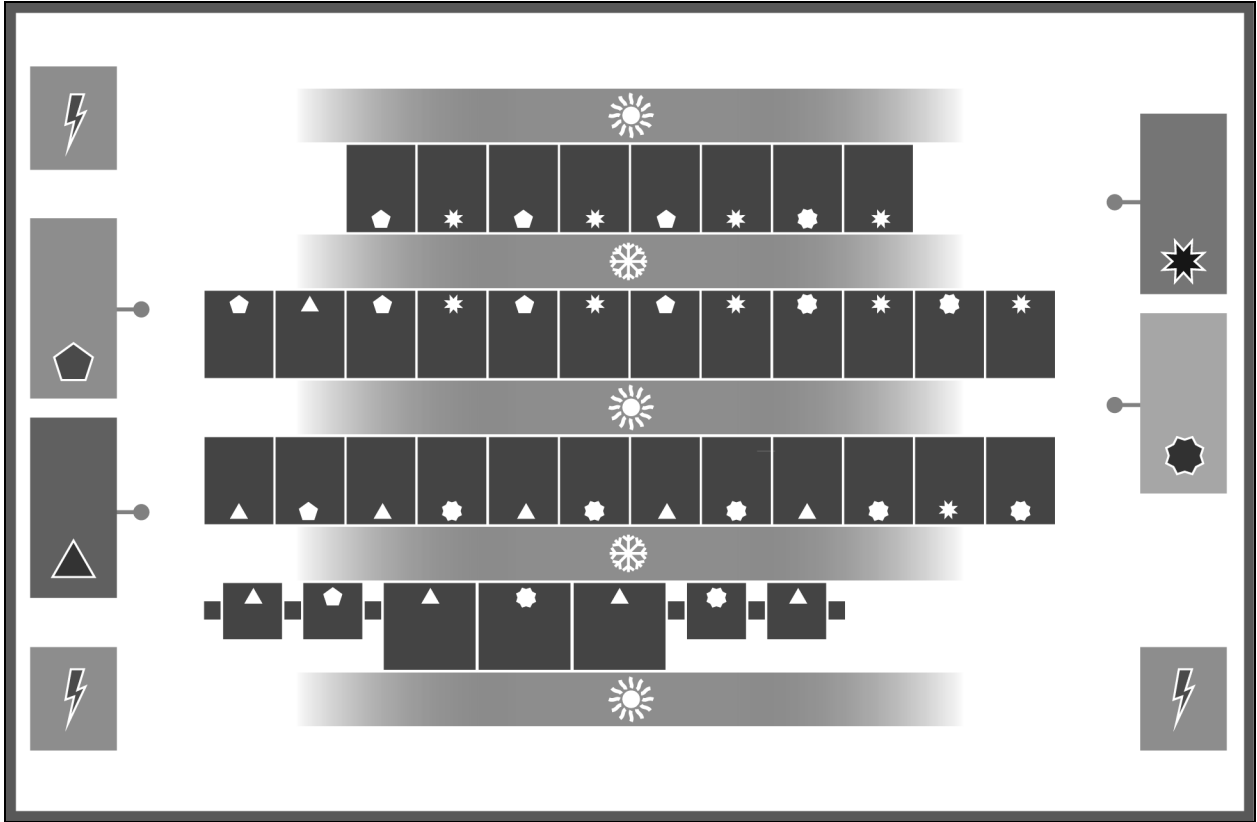

Tools required:

- Medium, flat head screw driver to open electric panel dead front
- Cutting tool to trim cable ties

The cooling units and rack sensors in **Figure 13.8** below are symbol coded to show how interlacing sensors from different cooling units provides redundancy and effective operation by sharing sensor data from the cooling units in Teamwork mode.

**Figure 13.8 Interlacing Sensor Placement**



Item	Description	Item	Description
	Unit 1		Cold aisle (front of racks)
	Unit 2		Hot aisle (rear of racks)
	Unit 3		Supply (discharge) temperature sensor
	Unit 4		Power distribution unit

To install the sensors on the racks:

**NOTE: Do not leave sensor probes coiled on top or coiled inside a rack. Do not install a sensor in the hot aisle, or if a sensor is installed in the hot aisle, make sure that it is set to reference to ensure that its readings are not used for fan or cooling control.**

1. Install the inlet rack temperature sensors on a rack in the area cooled by its connected unit as shown in **Figure 13.9** below .

**Figure 13.9 Rack Sensor Placement**

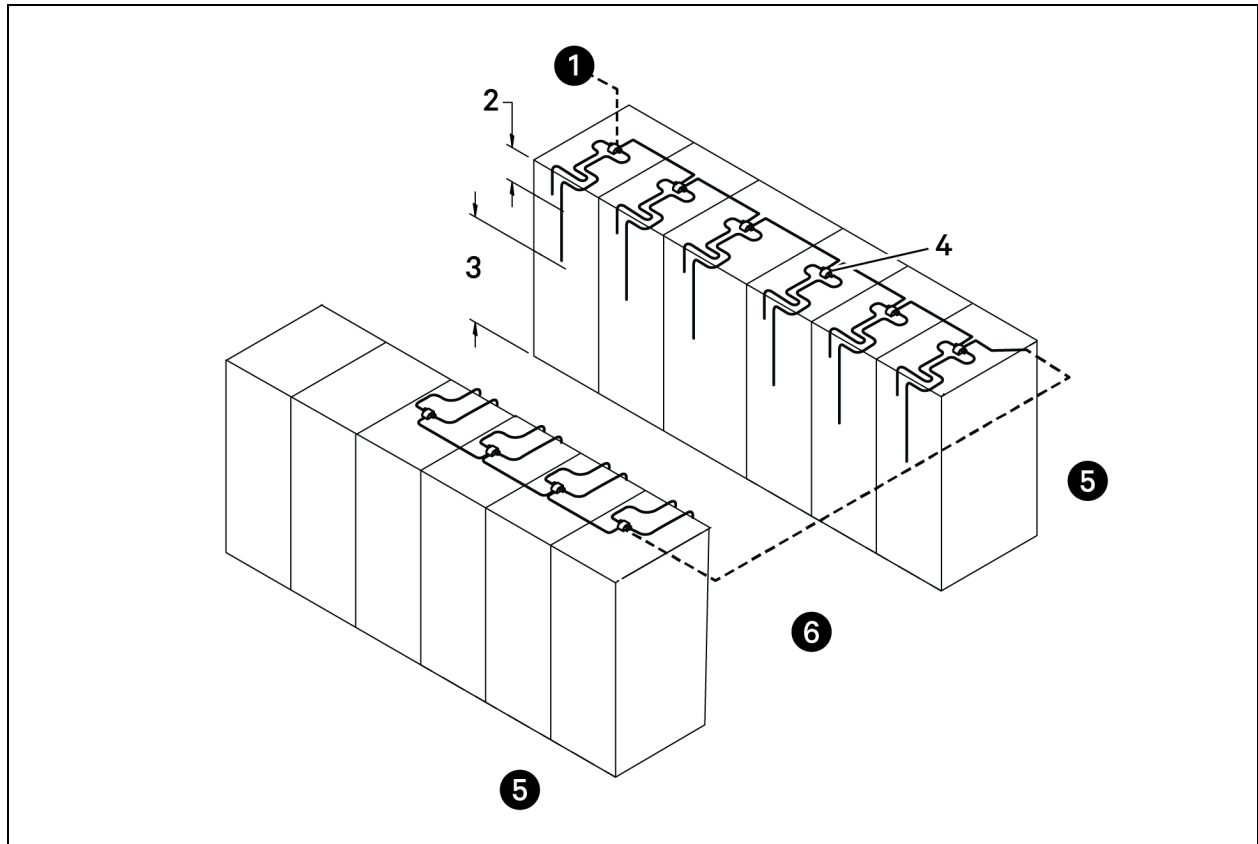

Item	Description
1	To cable entry in cooling unit
2	First probe, 12 in. (305 mm) from top
3	Second probe, in approximate center of rack and in front of the equipment
4	2T sensor with label visible
5	Hot aisle
6	Cold aisle

**NOTE: Both probes on the 2T sensor must be installed on the same rack.**

2. Install the 2T sensor probes the front door of the rack:
  - a. Using a cable tie, secure the sensor wire so that a probe is approximately 12 in. (305 mm) from the top and in the center of the front door. This sensor monitors hot air coming over the top of the rack from the hot aisle.

**NOTE: Do not wrap cable ties around the actual sensor probe. If the rack has no door, secure the probes to the rack at the side of the front opening.**

- b. Use a cable tie to secure the sensor wire of the second probe to the front door so that it is centered in front of the heat generating equipment drawing air.  
  
If the cabinet is completely filled with equipment, determine the center based on cabinet width and height.
  - c. With probes in place, use cable ties to route the wires neatly up the rack door and into the rack leaving enough slack in the wire so that the rack door opens and closes without binding or pinching the wire.
  - d. Using the supplied, hook-and-loop fastener, connect the 2T-sensor housing to the rack in an easily accessible location and with the sensor number visible.
3. Repeat step 2 until all sensors are installed.

### 13.2.4 Connect the CANbus Cable and Ground



**WARNING! Risk of electric shock. Can cause equipment damage, injury or death. Open all local and remote electric power supply disconnect switches and verify with a voltmeter that power is off before working within any electric connection enclosures. Service and maintenance work must be performed only by properly trained and qualified personnel and in accordance with applicable regulations and manufacturers' specifications. Opening or removing the covers to any equipment may expose personnel to lethal voltages within the unit even when it is apparently not operating and the input wiring is disconnected from the electrical source.**

Cabling considerations:

- For cable up to 150 ft. (45-m) long, no special considerations are needed.
- Cable 150 ft. (45 m) to 300 ft. (91 m) require a CANbus isolator.
- For cable longer than 300 ft. (91 m), contact the factory.
- The CANbus cable network requires a ground wire.

To connect the cables:

1. Connect CANbus cable and a ground wire between each sensor for the cooling unit, **Figure 13.10** below , taking the following precautions:

**NOTE: Remember that the last sensor on the chain must be terminated as described in [Terminating the Last Sensor on the CANbus link](#) on page 186 .**

- Use only approved hangers, and do not secure cables in a way that could damage them.
- Limit bends to less than four times the diameter of the cable.
- When securing and hanging, avoid deforming the cable.
- Keep cables away from devices that may cause interference such as high voltage wires, machinery, fluorescent lights and electronics.

**NOTE: High voltage sources must be at least 12 in. (305 mm) from CAN wires.**

- Avoid stretching cables.
- Avoid using excess cable between sensors.
- Make sure that cables have the correct pin out. Mismatched pins at the RJ12 connection will damage the CAN device.

**Figure 13.10 CANbus and Ground Connection on 2T Sensor**



2. Terminate the ground wire to a field installed ground ring in the low voltage electrical panel, as shown in **Figure 13.11** below .
3. Connect the CANbus cable to the cooling unit.  
On most cooling units, the connection points for the CANbus link are P66 and P67.

**Figure 13.11 Ground Wire Ring Connection**

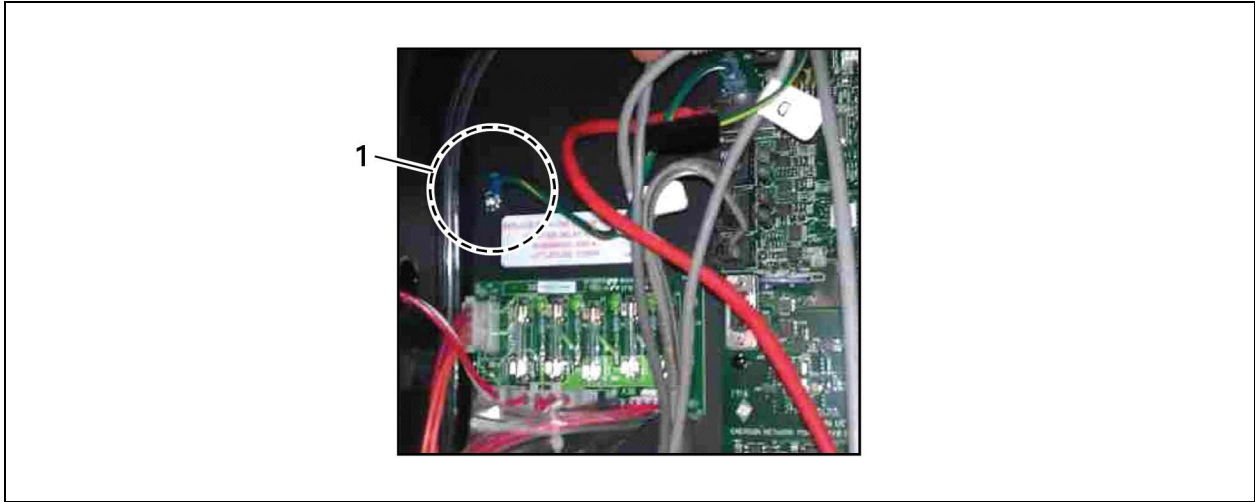

Item	Description
1	CANbus cable grounding ring connected to grounding screw in unit.

### 13.3 Installing a Fluid Temperature Sensor

1. Locate the DIP switches in the 2T sensor(s) by removing rear housing or via pre-cut hole in housing, **Figure 13.12** on the next page , and program according to **Table 13.4** below .  
**Figure 13.13** on the next page , shows the switch and on/off setting.

**Table 13.4 DIP Switch Settings in 2T Sensors**

	CANbus Node ID	DIP Switch Position							
		1	2	3	4	5	6	7	8
Fluid circuit 1	30	Off	On	On	On	On	Off	Off	Off
Fluid circuit 2	31	On	On	On	On	On	Off	Off	Off

Circuit 1 and 2 fluid sensors are dual-purpose CANbus IDs in firmware. These sensors might also be used for monitoring supply temperature. Before installing fluid temperature sensors, determine whether or not the supply-temperature 2T sensors are in use. Adding duplicate sensors will cause sensor communication loss.

Figure 13.12 Locating DIP Switches in 2T Sensor

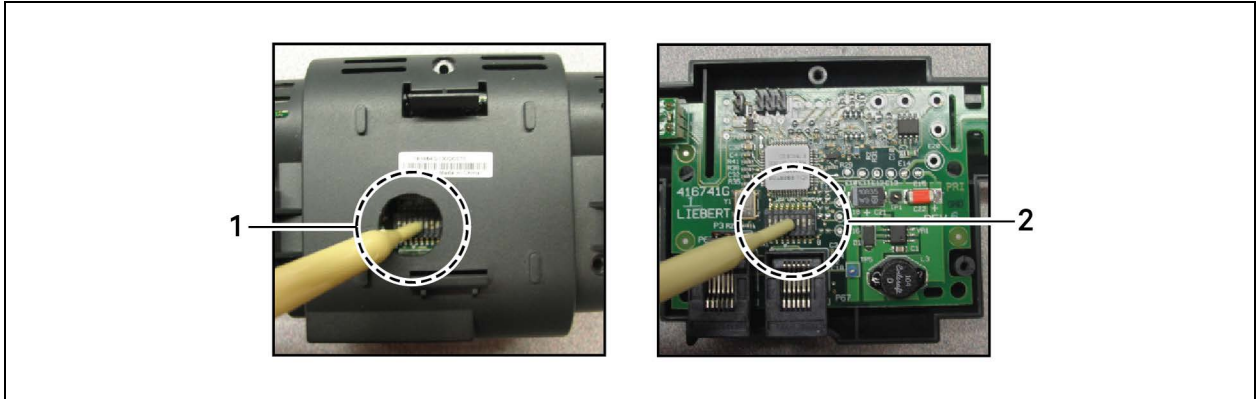

Item	Description
1	Hole in sensor housing
2	Cover removed

**NOTE:** Up is on, down is off on the DIP switch.

Figure 13.13 DIP Switches in 2T Sensor

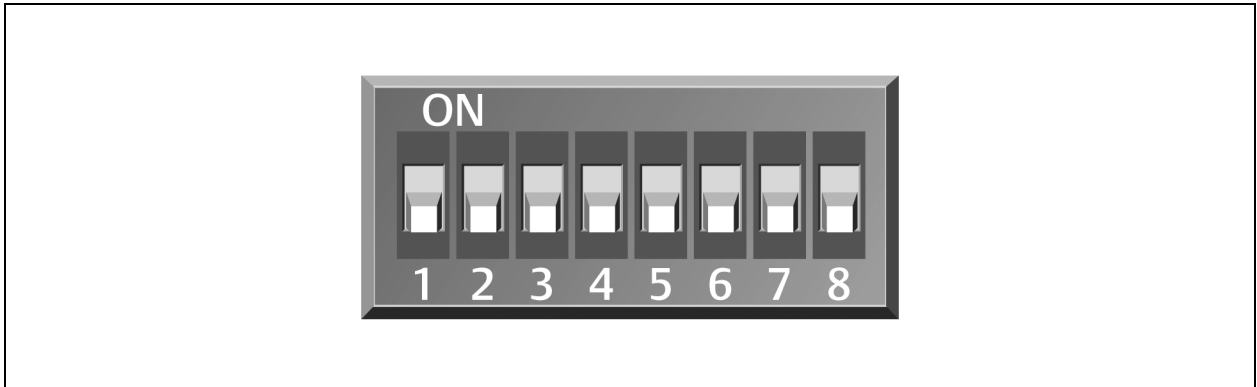

2. Once DIP switches are set, refer to [Terminating the Last Sensor on the CANbus link](#) on page 186 , then continue with step 3 .
3. On Vertiv™ Liebert® iCOM™:
  - In the Service menu, touch *Auxiliary Device Setup > Sensors > Fluid Sensors > Fluid 2T SensorCW T*. The SENSOR PROPERTIES panel opens.
  - In *Fluid Sensor Type*, select the type of 2T sensor.
4. At the fluid inlet and outlet, use a field supplied temperature sensor to verify the temperature readings, compare the Liebert® iCOM™ readings to the actual measured temperatures, and calibrate as needed.
  - If inlet and outlet temperature readings in Liebert® iCOM™ are reversed based on the field measurements, use Fluid Sensor 1/2 Placement to swap the readings.
5. Touch Save. The fluid temperature sensor settings are saved.

## 13.4 Installing Supply Control Sensors

### 13.4.1 Installing the Supply Air Temperature Sensor

The supply temperature sensor is connected to P8, Pins 1 and 2 at the factory and requires no configuration.

1. Place the sensor in an area that is influenced only by the unit to which it is connected to provide an accurate reading: 5 ft. to 15 ft. (1.5 m to 4.5 m) from the cooling unit, **Figure 13.14** below .

**NOTE:** A 50 ft. (15 m) extension cable is available from Vertiv™ if the sensor must be more than 15 ft. (4.5 m) from the Vertiv™ Liebert® iCOM™ unit.

2. Confirm connectivity via SENSOR DATA. See [Viewing Sensor Data](#) on page 20 .

**Figure 13.14** Placement of the Supply Air Temperature Sensor

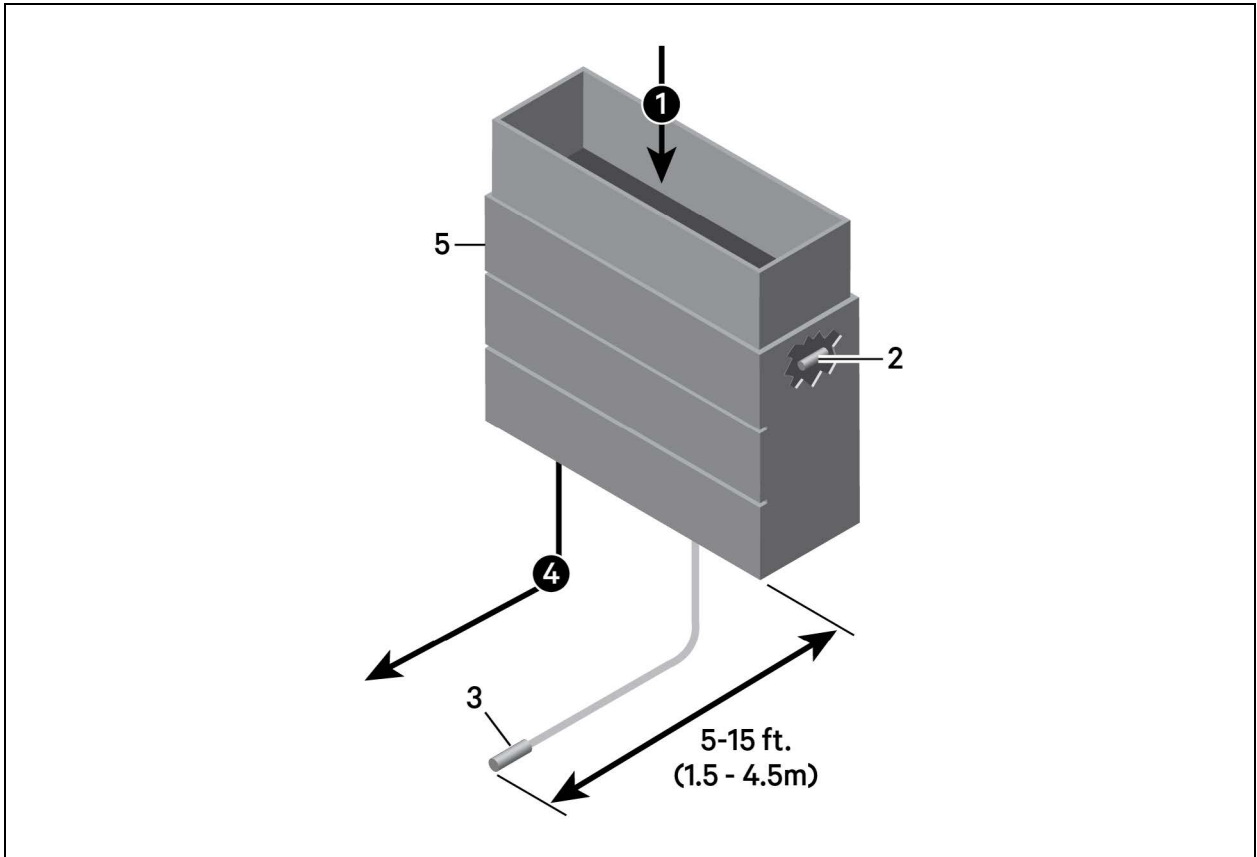

Item	Description
1	Return air
2	Internal temperature/humidity sensor
3	Temperature sensor
4	Supply air
5	Liebert® Thermal Management unit

### 13.4.2 Installing Aggregated Supply Air Temperature Sensors

On systems with large supply air plenums, up to five additional 2T sensors may be connected (via CANbus) in addition to the standard supply air sensor. Vertiv™ Liebert® iCOM™ then aggregates the readings and converts to average or maximum values for supply control.

**NOTE: The 2T sensors used for supply air sensor aggregation are identical to the wired remote sensors and are added in addition to the up to 10 remote sensors. You may install the supply air sensors at the end of the wired remote CANbus link or as a separate CANbus loop tied-back to the control board and properly terminated.**

The sensor array consists of 2T sensors that each have two temperature probes on a 6 ft. (1.8 m) probe connection cable and requires several steps to prepare, connect, and begin monitoring the racks:

- Set DIP switches in each sensor.
- Terminate final sensor on CANbus link.
- Install sensors.
- Install CANbus cabling between sensors.
- Connect CANbus cable to the cooling unit.
- Configure the sensors in Liebert® iCOM™.

### 13.5 Installing Analog Input Devices

External sensors and analog devices may be connected to Vertiv™ Liebert® iCOM™ using an electrical connection on the iCOM™ control board to a required, factory-supplied plug, harness and terminal strip. (Contact Vertiv™ technical support for parts.)

When equipped, devices as follows can be connected to terminals 41, 42, 43 and 44, 45 and 46, or 47 and 48. **Table 13.5** below, lists available analog inputs depending on the type of cooling unit.

See [Configuring Analog Input Devices](#) on page 157, to configure the Liebert® iCOM™ settings for the device.

**Table 13.5 Number of Analog Inputs Available by Cooling Unit Type**

Cooling Unit	Inputs Available
Liebert® CW and Liebert® PCW with MBV	4 2 may be used for valve feedback on CW, 1 on Liebert® PCW.
Liebert® CW and Liebert® PCW with 3P (floating point actuator)	4 2 may be used for valve feedback on CW, 1 on Liebert® PCW.
Liebert® DS and Liebert® DSE Air-cooled	2 Both used for low pressure transducers.
Liebert® DS Water/Glycol Cooling	0 Models without high pressure transducers may have 2.
Liebert® PDX Air Cooled	3 1 is used for low pressure transducers.
Liebert® PDX Water/Glycol Cooled	2 1 is used for a low pressure transducer. Optionally, a second for a high pressure transducer.



## 13.6 Installing the U2U Network

### 13.6.1 Required Network Equipment

Ethernet cable CAT5 or greater

- Maximum cable length is 328 ft. (100 m).
- An Ethernet repeater is required for cable lengths greater than 328 ft. (100 m).

Network switch

- IEEE 802.3; IEEE 802.3u
- 10/100 Mbps speed
- Multiple 10/100 RJ-45 ports, one shared.
- RJ-45 up link port

**NOTE:** Up to 32 cooling units may be connected in a U2U network.

### 13.6.2 Plan Wiring Runs

When planning the layout of the conditioned space, consider the following:

- Good wiring practices.
- An Ethernet repeater is required for cable lengths greater than 328 ft. (100 m).
- A private network that only connects and manages the cooling units is required.
- Keep control and communication cables away from power cables to prevent electromagnetic interference.
- Keep cables away from noise introducing devices such as machines, fluorescent lights, and electronics.
- Do not bend cables to less than four times the diameter of the diameter of the cable.
- Do not deform cables when hanging or securing in bundles.
- Do not exceed 25 lb (11 kg) of tension when pulling cables to avoid stretching.
- Do not damage cables when securing them. Use only approved hangers, such as telephone wire/RG-6 coaxial wire hangers.

### 13.6.3 U2U Wiring Connections

#### NOTICE

Cooling units are factory wired for stand alone operation. Do not connect the U2U network cabling before setting the U2U network configuration/groups. Network communication conflicts and unreliable display readings will result.

Before you begin, refer to [Preparing for U2U Group Set Up](#) on page 97 , and [Configuring U2U Network Settings](#) on page 98 .

– or –

Contact Vertiv™ Technical Support at 1-800-543-2778, opt. 5 or <https://www.vertiv.com/en-us/support/>.

## U2U Network Requirements

The network must be private:

- Isolated from other network traffic/non-Liebert Thermal equipment.
- Switches connecting the units must be dedicated to Vertiv™ Liebert® iCOM™ communication only.
- Do not connect the U2U network to the building or IT network. If the U2U network experiences a failure, the cooling units continue to operate independently.

Liebert® iCOM™ supports up to 64 nodes on the U2U network. The following are considered nodes:

- Input/output board (one in each cooling unit)
- Nine inch color touchscreen display or vNSA14-iCOM-H

Of the 64 nodes, up to 32 may be cooling unit input/output boards connected as a group. **Table 13.6** below , provides U2U network configuration examples.

**Table 13.6 Example Liebert® iCOM™ U2U Network Configurations**

Configuration Example	No. of Input/Output Boards (Cooling Units)	No. of Wall Mount Displays	Private Switch Required?
A	2	0	No
B	2	1	Yes
C	3	0	Yes
D	8	1	Yes
E	32	5	Yes
F	32	32	Yes

### 13.6.4 Wiring Cooling Units without Wall Mount Displays

**NOTE:** Cooling units are factory wired for stand alone operation. Do not connect the U2U network cabling before setting the U2U network configuration/groups. Network communication conflicts and unreliable display readings will result.

**NOTE:** Before you begin, refer to [Preparing for U2U Group Set Up](#) on page 97 , and [Configuring U2U Network Settings](#) on page 98 .

To connect two cooling units with a touchscreen, a network switch is not needed.

- Connect an Ethernet cable to the P64 connector on each Vertiv™ Liebert® iCOM™ control board as shown in Figure 13.15 below.

**Figure 13.15 Connection Between Only Two Cooling Units—No Network Switch Needed**

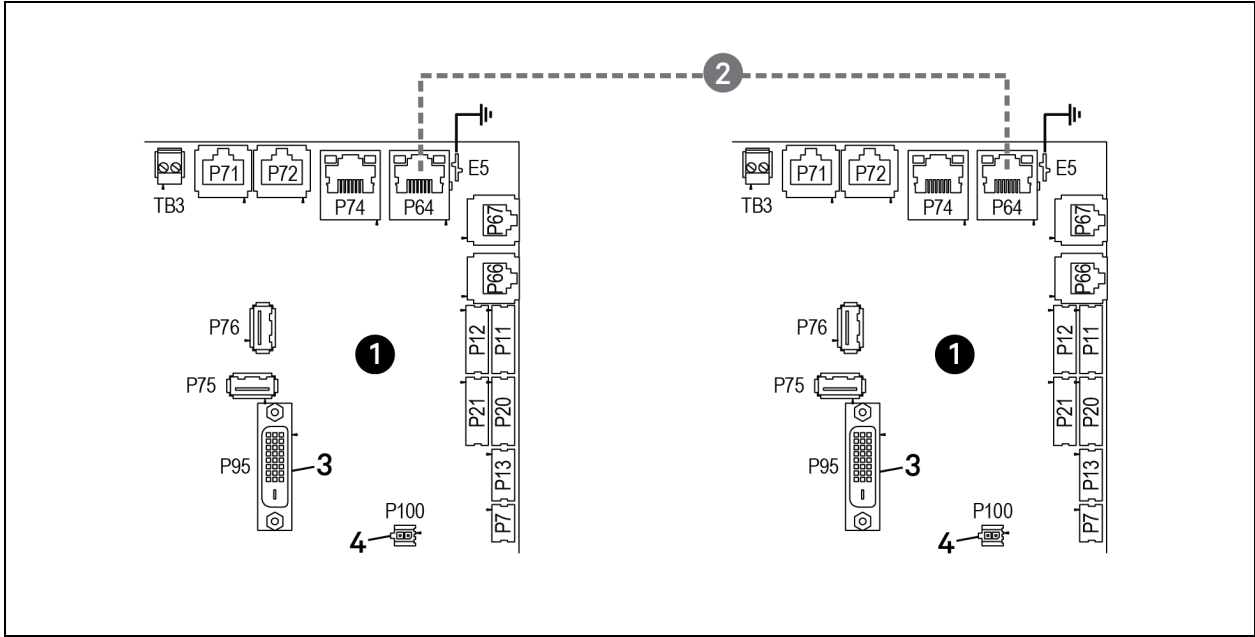

Item	Description
1	Liebert® iCOM™ microprocessor and I/O board
2	Ethernet cable (field supplied)
3	P95 DVI-D cable connection to Liebert® iCOM™ display
4	P100, power supply to Liebert® iCOM™ display

To connect two or more cooling units into one group (maximum of 32 units per group, up to 99 groups), a network switch is required.

- On each unit, connect one end of an Ethernet cable to the P64 connector on each Vertiv™ Liebert® iCOM™ control board, and the other end to the U2U network switch, see **Figure 13.16** below .

**Figure 13.16 Connecting Two or More Units with a Network Switch**

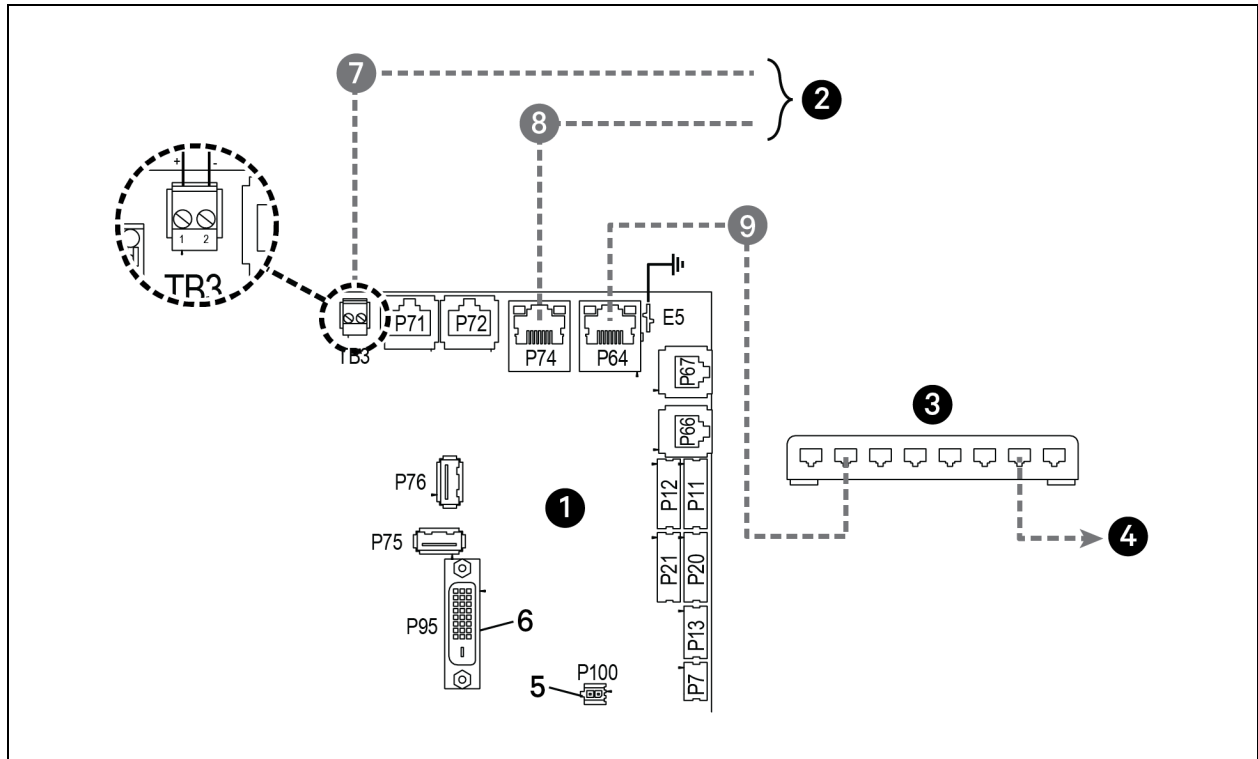

Item	Description
1	Liebert® iCOM™ microprocessor and I/O board
2	Site and BMS communication connections
3	Network switch (field supplied)
4	To/From other networked units
5	P100, power supply to Liebert® iCOM™ display
6	P95 DVI-D cable connection to Liebert® iCOM™ display
7	RS485 cable
8	Ethernet cable
9	Ethernet cable (field supplied)

## 13.6.5 Wiring Cooling Units with Wall Mount Displays

**NOTE:** Cooling units are factory wired for standalone operation. Do not connect the U2U network cabling before setting the U2U network configuration/groups. Network communication conflicts and unreliable display readings will result.

**NOTE:** Before you begin, refer to [Preparing for U2U Group Set Up](#) on page 97 , and [Configuring U2U Network Settings](#) on page 98 .

Nine inch color touchscreen display or VNSA14-iCOM-H may be used to remotely configure, control, and monitor all cooling units connected on the U2U network.

- Each display requires 120 VAC or 230 VAC input power.

### To connect wiring:

1. On each wall mount display (32 maximum), connect one plug of a straight through Ethernet cable to port P64 on the rear of the display.
2. Connect the other end to the U2U network switch.

This page intentionally left blank

# Appendices

## Appendix A: Technical Support and Contacts

### A.1 Technical Support/Service in the United States

Vertiv Group Corporation

24x7 dispatch of technicians for all products.

1-800-543-2378

Liebert Thermal Management Products

1-800-543-2378

Liebert Channel Products

1-800-222-5877

Liebert AC and DC Power Products

1-800-543-2378

### A.2 Locations

#### United States

Vertiv Headquarters

505 N. Cleveland Ave.

Westerville, OH 43082, USA

#### Europe

Via Leonardo Da Vinci 8 Zona Industriale Tognana

35028 Piove Di Sacco (PD) Italy

#### Asia

7/F, Dah Sing Financial Centre

3108 Gloucester Road

Wanchai, Hong Kong

This page intentionally left blank





## Appendix B: Setpoints and Alarm Settings by Line ID

These tables list the parameters by the line identification assignments employed before the Vertiv™ Liebert® iCOM™ touchscreen. The tables include range/options of the parameter, the factory-default setting, and a description of the parameter function.

The line IDs are not listed in the User or Settings menus, only in the parameter directory. You can search the parameter list to find the line ID and its associated label and value in the Liebert® iCOM™ user interface.

To search the parameters list:

1. Log in at the Service level, then touch  >  > Parameter Directory.
2. Enter a line ID or term in the Search field, and touch .

### B.1 Line IDs for Setpoint Parameters

Table B.1 Service Menu Setpoints by Line ID

Line ID	Parameter Name	Range	Default Setting	Description
S102.1	Temperature Control Sensor	Supply Sensor Return Sensor Remote Sensor	Return Sensor	Selects which sensor will be controlling/influencing the cooling capacity. Cooling capacity is either the chilled water valve, compressor, free cooling valve, or air economizer. Unloading type compressors can be set to any sensor type; however, fixed style compressors can only be set to Return or Remote control sensor.
S103.1	Temperature Setpoint Actual	32 - 113 °F 0.0 - 45.0°C	73°F 23.0°C	The temperature setpoint actual value is a read-only value that indicates if another routine, such as supply compensation has internally modified the Temperature controlling value. If compensation has not been activated, the ACT and SET will always match.
S103.2	Temperature Setpoint	41 - 104°F 5.0 - 40.0°C	73°F 23.0°C	Selects a temperature that the cooling unit will maintain by applying cooling and/or reheats. The temperature setpoint value that has been set by the User to control the temperature.
S104.1	Temperature Control Type	Proportional PI Adaptive PID Intelligent	PI	Sets the type of control to be followed: Proportional, PI, Adaptive PID (auto-tuning), Intelligent
S105.1	Temperature User Low Limit	41 - 104°F 5.0 - 40.0°C	41°F 5.0°C	Defines the temperature range below setpoint; temperature setpoint cannot be adjusted below this value. If the setpoint value has been adjusted lower than this setting, then the setpoint will automatically default back to its previous setting.
S105.2	Temperature User High Limit	41 - 104°F 5.0 - 40.0°C	10°F 4.0 °C	Defines the temperature range above setpoint; temperature setpoint cannot be adjusted above this value. If the setpoint value has been set higher than this setting, then the setpoint will automatically default back to its previous setting.
S106.1	Temperature Proportional Band	4 - 200°F 2.2 - 111.0 K	12°F 6.7 K	Adjusts the activation points of compressors/chilled water valves or rate of changed based on the actual sensor values deviation from setpoint. The smaller this number, the faster the compressors/chilled water values will increase capacity. Too small of a number may cause the unit to short cycle compressors or excessively reposition the valve.
S106.2	Temperature Integral Time	0.0 - 15.0 min	5.0 min	Adjusts the capacity of the units based on time away from setpoint so that accurate temperature control can be maintained. The proportional and integral time settings work together to maintain setpoint. Large p-band and small integral time is typical when controlling to supply air.

**Table B.1 Service Menu Setpoints by Line ID (continued)**

Line ID	Parameter Name	Range	Default Setting	Description
S107.1	Temperature Derivative Time	0 - 900 sec	0 sec	
S108.1	AutoSet Enable	No Yes	Yes	Sets the temperature and humidity proportional bands automatically based on the type of unit when this parameter is set to YES and if teamwork modes are selected. To change the proportional bands, this parameter must be set to NO. If supply or remote sensors are used, then this value is always set to NO.
S109.1	Temperature Deadband	0 - 36°F 0 - 20.0 K	2°F 1.1 K	Avoids overshooting of the setpoint and cycling between cooling and reheats. The value entered in this field will be split in half by the temperature setpoint.
S110.1	Supply Limit Enabled	No Yes	No	Chilled water units may be set up with the supply air sensor to maintain a minimum air temperature under the raised floor to help prevent condensation. In order to avoid supply temperatures that are too low, the Supply Limit can influence the opening of three-point or analog actuators or the output of analog values. The control compares the deviation from the return air setpoint & the supply limit setpoint, and calculates the output to the actuator from the smaller deviation.
S110.2	Supply Limit Setpoint	41 - 81°F 5.0 - 27.0°C	41°F 5.0°C	
S111.1	Heater Deadband	0 - 36°F 0 - 20.0 K	0°F 0.0 K	Changes the amount of deviation below the temperature setpoint that the heaters will cycle ON and OFF. This value is added to the heating side of the normal temperature deadband.
S113.1	Enable Temperature Compensation	No Return Supply Ret+Sup	No	Temperature compensation allows for a second or even a third sensor to be used that will influence the units cooling or heating. Return compensation can be used when the supply or remote sensors are being used for control. Then the return sensor is then monitored to maintain a minimum return temperature. Supply compensation can be used only when Optimized Aisle (TW3) is enabled. The supply sensor will not only be used for controlling cooling capacity but will also monitor the cold aisle temperature to ensure that the cold aisle temperature setpoint is met.
S114.1	Return Compensation Setpoint	41 - 104°F 5.0 - 40.0°C	73°F 23.0°C	The temperature setpoint where compensation begins to operate by increasing the supply air setpoint.
S115.1	Return Compensation Value	0 - 18°F 0.0 - 10.0 K	0°F 0.0 K	The return compensation band/value will determine how quickly the cooling capacity is adjusted as the return temperature drops below the return compensation setpoint.
S115.2	Return Compensation Band	0 - 18°F 0.0 - 10.0 K	0°F 0.0 K	
S116.1	Supply Compensation Value	0 - 18°F 0.0 - 10.0 K	0°F 0.0 K	The Supply Compensation value determines how much the supply temperature setpoint will be reduced when the units fan speed is at 100% and the cold aisle is not able to maintain temperature setpoint. Any modifications to the supply temperature setpoint will be shown at the temperature setpoint on parameter S103 as the actual active control point.
S121.1	CW Capacity Filter @ 100%	0.01 - 99.99 %/s	0.60 %/s	At the end of the p-band (at 100% call for cooling), it is typically set higher (faster)
	BMS Backup Temp Setpoint	41 - 104°F 5.0 - 40.0°C	73°F 23.0°C	Selects a temperature setpoint that will be activated in the event of a BMS timeout. The BMS timer must be configured for this parameter to be active.
U113.1	2nd Temperature Setpoint	41 - 104°F 5.0 - 40.0°C	73°F 23.0°C	Selects a temperature setpoint that will be activated in the event of a customer input signal configured as the second setpoint. The customer input must be configured for the parameter to activate.

**Table B.1 Service Menu Setpoints by Line ID (continued)**

Line ID	Parameter Name	Range	Default Setting	Description
S124.1	Humidity Control Sensor	Remote Sensor Return Sensor	Return Sensor	Defines which humidity sensor the humidity setpoint is compared with. The return sensor is equipped with a Temp/Hum sensor and can calculate the dew point based on Liebert® iCOM™'s internal look up table. If a sensor other than the return sensor is selected, the Liebert® iCOM™ will calculate the corresponding RH % based on that sensors actual temperature.
S125.1	Dew Point Setpoint & Humidity Setpoint	41 - 65°F 5.0 - 18.3°C	48°F 8.9°C	Selects a humidity level that the cooling unit will maintain by removing or adding moisture to the air. The humidity setpoint will either be set in percent RH or as a dew point value, depending on what the humidity control type is set for.
S126.1	Humidity Control Type	Relative Compensated Predictive Dew Point	Predictive	Selects the humidity control calculation. Setting this parameter to relative (%RH) will control the humidity without considering any temperature deviations. Predictive and Absolute control consider the temperature deviation from temperature setpoint so that a constant level of moisture is kept in the area based on the humidity sensor reading and the temperature deviation from setpoint. Compensated is recalculated with the actual deviation from temperature setpoint. 1° Celsius is equal to 3 % RH, indirect proportional. If temperature increases, the humidity setpoint is decreased and vice versa.
S127.1	Humidity Proportional Band	1 - 20%	0.2	Adjusts the activation points of the humidifier and compressors based on the actual sensor values deviation from setpoint. The smaller this number, the faster the compressors and humidifier will increase capacity. Too small of a number may cause the unit to short cycle or overshoot setpoint.
S127.2	Dew Point Proportional Band	2 - 18°F 1.1 - 10.0 K	8°F 4.4 K	
S128.2	Humidity Integration Time	0.0 - 25.0 min	0.0 min	Adjusts the capacity of the unit based on a time away from setpoint so that accurate humidity control can be maintained. If the integration time is set to 0, the humidity control operates as a proportional only control. When integration time is set, the control mode changes to PI control
S129.1	Humidity Deadband	0 - 18°F 0.0 - 10.0 K	4°F 2.2 K	Prevents overshooting of the setpoint and cycling between humidification and dehumidification. The value entered in this field will be split in half by the temperature setpoint.
S146.1	Fan Control Sensor	Supply Sensor Remote Sensor Return Sensor Manual	Return Sensor	Controls the fan speed for modulation. If MANUAL is selected, then the fan speed can be controlled from the local display or through a building management system.
S147.1	Fan Setpoint	41 - 104°F 5.0 - 40.0 °C	73°F 22.8°C	Activated when a temperature sensor is being used to control the fan speed. If the same sensor is used for temperature control and fan speed control, then this value will reflect the same setpoint as the temperature control setpoint. Manual mode uses fan speed STD for control.
S148.1	Fan Temperature Control Type	Proportional PI Adaptive PID	PI	Sets the type of control the unit will use to control fan speed. PI control gain is set in the Temp Prop/Integral parameter. PI control will operate the fan speed so that the actual temperature of the fan control sensor is equal to the fan temp setpoint. If PROPORTIONAL only is selected, the fan will change ONLY based on the deviation from setpoint which will allow the actual temp to settle higher than setpoint.
149.1	Fan Temperature Control Prop Band	4 - 200°F 2.0 - 111.0 K	36°F 20.0 K	Adjusts the fan speed rate of change based on the actual sensor values deviation from setpoint. The small this number, the faster the fans will increase speed. Too small of a number may cause the fans increase/decrease to overshoot setpoint
149.2	Fan Temperature Control	0.0 - 15.0 min	1.0 min	Adjusts the fans of the unit based on time away from setpoint so that accurate temperature control can be maintained. The proportional and integral work together to maintain setpoint. Large p-band with small integral time is a typical way to achieve

**Table B.1 Service Menu Setpoints by Line ID (continued)**

Line ID	Parameter Name	Range	Default Setting	Description
	Integration Time			stable control.
S150.1	Fan Hysteresis	0 - 20%	0.02	Modifies the reaction of the fan speed when fan speed is being dictated by the Call for Cooling. Adding the Hysteresis may result in a lagged response to changes in fan speed.
S150.2	Fan Deadband	0 - 36°F 0 - 20.0 K	°F 0.6 K	Avoids overshooting of the setpoint. The value entered in this field will be split in half by the fan speed setpoint.
S151.1	Airflow Calibration	3.0 - 10.0 V	10.0 V	Allows the front display to be scaled to show the actual percentage of airflow independent of the voltage operating the fan speed. This value cannot be set above/below the Analog Output High/Low Limit for the fan set in the Advanced Menu. This also includes the service menu fan speed parameters.
S152.1	Fanspeed VSD Setpoint Minimum	0 - 100%	0.7	Sets the range for the variable fans. Min sets the minimum speed at which the fan will operate. Fan speed is modulated between MIN and STD based on which sensor is set as the controlling sensor, setpoint and the PI settings. If the controlling sensor is set to manual, then the STD setting will control the current fan speed. This parameter is also adjustable through the BMS.
S152.2	Fanspeed VSD Setpoint Standard	0 - 100%	1	
S157	Fan Startup Time	0 - 600 sec	3 sec	Determines the speed of the fan at system start up. The fan will operate at the set speed (%) until the set time has elapsed; at this point the fan will assume normal operation.
	Fan Startup Speed	0 - 100%	100%	

## B.2 Line IDs for Alarm Setting Parameters

**Table B.2 Service Menu Alarm Settings by Line ID**

Line ID	Parameter Name	Range	Default Setting	Description
S202	Return Sensor Alarms Enable	Disabled Enabled	Enabled	Enables or disables the return temperature and humidity sensor alarms.
	Return Sensor Alarms Init Delay	10 - 9999 sec	90 sec	
S203	High Return Temperature Alarm	34 - 210 °F 1.0 - 99.0 °C	100 °F	Sets the temperature threshold for the high/low return temperature alarms.
	Low Return Temperature Alarm	34 - 210 °F 1.0 - 99.0 °C	65 °F	
S204	High Return Humidity Alarm	1.0 - 99.0 %	0.65	Sets the humidity threshold for the high/low return temperature alarms.
	Low Return Humidity Alarm	1.0 - 99.0 %	0.35	
S205	Sensor A Alarms Enable	Disabled Enabled	Disabled	Enables or disables the alarms associated with Sensor A and sets the time delay before the alarm is annunciated.

Table B.2 Service Menu Alarm Settings by Line ID (continued)

Line ID	Parameter Name	Range	Default Setting	Description
	Sensor A Alarms Init Delay	10 - 9999 sec	90 sec	
S206	Sensor A Low Temperature Alarm	34 - 210 °F 1.0 - 99.0 °C	55 °F	Sets the temperature threshold when Sensor A high/low temperature alarm will occur.
	Sensor A High Temperature Alarm	34 - 210 °F 1.0 - 99.0 °C	90 °F	
S207	Sensor A Low Humidity Alarm	1.0 - 99.0%	30.0%	Sets the temperature threshold when Sensor A high/low humidity alarm will occur.
	Sensor A High Humidity Alarm	1.0 - 99.0%	70.0%	
S208	Warning Activates Alarm Relay	No Yes	Yes	When set for Yes, a Warning event type will activate the Alarm Relay as well as an Alarm event type.
S209	K11 (WA Relay) Active On	0 = Dehum 1 = Warning 2 = Emergency Pwr 3 = Freecooling 4 = FC Start	Warning	The Warning Relay (WA Relay) can be activated for different purposes; during a call of Dehumidification during a warning event type, when unit is on Emergency Power and a Customer Input Alarm is configured for Emergency Pwr, during free cooling, or during free cooling (FC) Start.
S210	K11(WA Relay) and AL Relay	Direct Reverse	Direct	Determines whether the K11 (WA Relay) is direct or reverse acting.
S211	Water Alarm Shuts Down Unit	No Yes	No	The controller can be configured to shut the following down during an active Water Alarm: <ul style="list-style-type: none"> <li>Shutdown the entire unit</li> <li>Shutdown humidification operation</li> </ul>
	Water Alarm Hum Fill Down	No Yes	No	
S21A	Loss of Flow Compressor Timer	0 - 180 sec	0 sec	Allows setting a maximum pumpdown time during a loss of flow condition to prevent causing a high-pressure alarm due to pumpdown with no water/glycol flow to the condenser; hidden unless pumpdown is enabled; applies only to water/glycol-cooled systems
S21B	Loss of Flow Threshold	0 - 100 %	0.1	Sets the threshold for call for cooling loss of flow.
S213	Supply Sensor Alarms Enable	Disabled Enabled	Disabled	Enables or disables the supply sensor alarms. If the unit is not equipped with a supply temperature sensor, then this parameter will show Disabled. A user may also select the time delay before the alarm will become active.
	Supply Sensor Alarms Init Delay	10 - 9999 sec	90 sec	
S214	High Supply Temperature	34 - 210 °F 1.0 - 99.0 °C	75 °F	Sets the high and low supply temperature threshold at which the alarms will be triggered.
	Low Supply Temperature	34 - 210 °F 1.0 - 99.0 °C	50 °F	
S215	Dew Point Alarms Enable	Disabled Enabled	Disabled	Enables or disables the Return Air Dew Point alarm. Dew point alarms can be enabled with any humidity control type. Dew point alarms may be used with or without humidification or dehumidification options selected. A user may adjust the time delay before the alarm is activated.
	Dew Point Alarms Init Delay	10 - 9999 sec	90 sec	

**Table B.2 Service Menu Alarm Settings by Line ID (continued)**

Line ID	Parameter Name	Range	Default Setting	Description
S216	High Dew Point	34 - 210 °F 1.0 - 99.0 °C	59 °F	Sets the high/low dew point threshold.
	Low Dew Point	34 - 210 °F 1.0 - 99.0 °C	39 °F	
S217	Sensor A Dew Point Alarms Enable	Disabled Enabled	Disabled	Enables or disables the optional Sensor A Dew Point alarm. Dew Point alarms can be enabled with any humidity control type. Dew point alarms may be used with or without humidification or dehumidification options selected. A user may adjust the time delay before the alarm is activated.
	Sensor A Dew Point Alarms Init Delay	10 - 9999 sec	90 sec	
S218	High Dew Point Sensor A	34 - 210 °F 1.0 - 99.0 °C	62 °F	Sets the high/low Sensor A dew point thresholds.
	Low Dew Point Sensor A	34 - 210 °F 1.0 - 99.0 °C	36 °F	
S219	Remote Sensor Alarms Enable	0 = Disabled 1 = Com Set 2 = Sep Set	Disabled	Disable prevents remote temperature sensor alarms from occurring. Com Set or common setting allows remote alarm activation based on a common alarm setting. Sep Set, or separate setting allows the user to program unique temperature alarm settings. A user may adjust the time delay before the alarm is activated.
	Remote Sensor Alarms Init Delay	10 - 9999 sec	180 sec	
S220	High Remote Temperature	34 - 210 °F 1.0 - 99.0 °C	90 °F	Sets the high/low remote sensor alarm thresholds.
	Low Remote Temperature	34 - 210 °F 1.0 - 99.0 °C	55 °F	
S222	EEV Alarm Board	0 = NO 1 = NC	1 (NC)	
S22A	Operation on Sensor Failure	0 = Cooling 1 = Shutdown	0 (Cooling)	Selects function to occur if the temperature control sensor fails. Full = Full, CFC Hold = hold last CFC
	Operation on Sensor Failure Cooling Mode	0 = Full 1 = Hold	0 (Full)	

Table B.2 Service Menu Alarm Settings by Line ID (continued)

Line ID	Parameter Name	Range	Default Setting	Description
S224 - S233, S23A,	Customer Input 1 - 11	0 = Smoke 1 = Water Alarm 2 = C PMP Alarm 3 = Flow Alarm 4 = Stdby G Pump 5 = Stdby Unit 6 = C-Input 1 7 = C-Input 2 8 = C-Input 3 9 = C-Input 4 10 = Rht Lockout 11 = Hum Lockout 12 = Rht+Hum Lock 13 = Comp Lockout 14 = Call Service 15 = High Temp 16 = Air Loss 17 = FC Lockout 18 = Heater Alarm 19 = Flow AL SD 20 = Flow AL LC	1 (Water Alarm) for inputs 1-4  38 (Not Used) for inputs 5-11	Selects the device and operation of the Customer Inputs. Each event reflects a different alarm scenario and possible action to the unit. A user may select whether the customer input is normally open or normally closed. If the parameter is configured for Factory STD., then it indicates that this input is factory configured and is not configurable in the field.
S224 - S233, S23A, (Cont'd)	Customer Input 1 - 11 (Cont'd)	21 = Comp Lock PD 22 = Enable FC 23 = HTRJ VFD 24 = HTRJ SPD 25 = Fire Alarm 26 = 2nd Setpoint 27 = Emergency Pwr 28 = LSI 29 = Cond 1 Fail 30 = Cond 2 Fail 31 = D-Scroll Red 32 = Swap Valve 33 = EC Fan Fault 34 = Eco Airflow 35 = Damper Switch 36 = Power A 37 = Power B 38 = Not Used 39 = Flow AL LFC 40 = Hand Mode 41 = Fan Overrd. 42 = Cool Overrd	1 (Water Alarm) for inputs 1-4  38 (Not Used) for inputs 5-11	Selects the device and operation of the Customer Inputs. Each event reflects a different alarm scenario and possible action to the unit. A user may select whether the customer input is normally open or normally closed. If the parameter is configured for Factory STD., then it indicates that this input is factory-configured and is not configurable in the field.
S224 - S233, S23A, (Cont'd)	Customer Input Active open/closed	Closed Open	Closed	A user may select if the customer input is active when contacts are open or closed.
S236	Event Delay Time (sec)  Event Enabled  Event: MAIN FAN OVERLOAD	10 - 9999 sec  Disabled Enabled  MESSAGE WARNING ALARM	10 sec  Enabled  ALARM	Main fan overload.
S237	Initial Loss of	10 - 600 sec	30 sec	Loss of airflow.

**Table B.2 Service Menu Alarm Settings by Line ID (continued)**

Line ID	Parameter Name	Range	Default Setting	Description
	Airflow Delay			
	Event Delay Time (sec)	10 - 9999 sec	30 sec	
	Event Enabled	Disabled Enabled	Enabled	
	Event: LOSS OF AIRFLOW	MESSAGE WARNING ALARM	ALARM	
S238	Event Delay Time (sec)	10 - 9999 sec	10 sec	Clogged filters.
	Event Enabled	Disabled Enabled	Enabled	
	Event: CLOGGED FILTERS	MESSAGE WARNING ALARM	WARNING	
S239	Event Delay Time (sec)	10 - 9999 sec	30 sec	High room temperature.
	Event Enabled	Disabled Enabled	Enabled	
	Event: HIGH ROOM TEMP	MESSAGE WARNING ALARM	WARNING	
S240	Event Delay Time (sec)	10 - 9999 sec	30 sec	Low room temperature.
	Event Enabled	Disabled Enabled	Enabled	
	Event: LOW ROOM TEMP	MESSAGE WARNING ALARM	WARNING	
S241	Event Delay Time (sec)	10 - 9999 sec	30 sec	High room humidity.
	Event Enabled	Disabled Enabled	Enabled	
	Event: HIGH ROOM HUM	MESSAGE WARNING ALARM	WARNING	
S242	Event Delay Time (sec)	10 - 9999 sec	30 sec	Low room humidity.
	Event Enabled	Disabled Enabled	Enabled	
	Event: LOW ROOM HUM	MESSAGE WARNING ALARM	WARNING	
S243	Event Delay Time (sec)	10 - 9999 sec	30 sec	High temperature Sensor A.
	Event Enabled	Disabled Enabled	Disabled	
	Event: HIGH TEMP SENSOR A	MESSAGE WARNING ALARM	WARNING	
S244	Event Delay Time (sec)	10 - 9999 sec	30 sec	Low temperature Sensor A.
	Event Enabled	Disabled Enabled	Disabled	



Table B.2 Service Menu Alarm Settings by Line ID (continued)

Line ID	Parameter Name	Range	Default Setting	Description
	Event: LOW TEMP SENSOR A	MESSAGE WARNING ALARM	WARNING	
S245	Event Delay Time (sec)	10 - 9999 sec	30 sec	High humidity sensor A.
	Event Enabled	Disabled Enabled	Disabled	
	Event: HIGH HUM SENSOR A	MESSAGE WARNING ALARM	WARNING	
S246	Event Delay Time (sec)	10 - 9999 sec	30 sec	Low humidity sensor A.
	Event Enabled	Disabled Enabled	Disabled	
	Event: LOW HUM SENSOR A	MESSAGE WARNING ALARM	WARNING	
S249	Event Delay Time (sec)	—	—	Compressor 1 overload.
	Event Enabled	Disabled Enabled	Enabled	
	Event: COMP 1 OVERLOAD	MESSAGE WARNING ALARM	ALARM	
S250	Event Delay Time (sec)	—	—	Compressor 2 overload.
	Event Enabled	Disabled Enabled	Enabled	
	Event: COMP 2 OVERLOAD	MESSAGE WARNING ALARM	ALARM	
S251	Event Delay Time (sec)	—	—	Circuit 1 high pressure.
	Event Enabled	Disabled Enabled	Enabled	
	Event: CIRCUIT 1 HIGH PRESS	MESSAGE WARNING ALARM	ALARM	
S252	Event Delay Time (sec)	—	—	Circuit 2 high pressure.
	Event Enabled	Disabled Enabled	Enabled	
	Event: CIRCUIT 2 HIGH PRESS	MESSAGE WARNING ALARM	ALARM	
S253	Event Delay Time (sec)	—	—	Circuit 1 low pressure.
	Event Enabled	Disabled Enabled	Enabled	
	Event: CIRCUIT 1 LOW PRESS	MESSAGE WARNING ALARM	ALARM	

**Table B.2 Service Menu Alarm Settings by Line ID (continued)**

Line ID	Parameter Name	Range	Default Setting	Description
S254	Event Delay Time (sec)	—	—	Circuit 2 low pressure.
	Event Enabled	Disabled Enabled	Enabled	
	Event: CIRCUIT 2 LOW PRESS	MESSAGE WARNING ALARM	ALARM	
S255	Event Delay Time (sec)	—	—	Circuit 1 pump down failure.
	Event Enabled	Disabled Enabled	Enabled	
	Event: CIRCUIT 1 PUMPD. FAIL	MESSAGE WARNING ALARM	ALARM	
S256	Event Delay Time (sec)	—	—	Circuit 2 Pump down failure.
	Event Enabled	Disabled Enabled	Enabled	
	Event: CIRCUIT 2 PUMPD. FAIL	MESSAGE WARNING ALARM	ALARM	
S257	Event Delay Time (sec)	—	—	Digital scroll 1 high temperature.
	Event Enabled	Disabled Enabled	Enabled	
	Event: DIG SCROLL1 HIGH TEMP	MESSAGE WARNING ALARM	ALARM	
S258	Event Delay Time (sec)	—	—	Digital scroll 2 high temperature.
	Event Enabled	Disabled Enabled	Enabled	
	Event: DIG SCROLL2 HIGH TEMP	MESSAGE WARNING ALARM	ALARM	
S259	Event Reset Type	0 = AR 1 = MR	0 (AR)	Electric heat high temperature. AR = Auto Reset, MR = Manual Reset.
	Event Delay Time (sec)	10 - 9999 sec	10 sec	
	Event Enabled	Disabled Enabled	Enabled	
	Event: EL HEAT HIGH TEMP	MESSAGE WARNING ALARM	ALARM	
S262	Event Delay Time (sec)	10 - 9999 sec	10 sec	Working hours exceeded.
	Event Enabled	Disabled Enabled	Enabled	
	Event: UNIT HRS EXCEEDED	MESSAGE WARNING ALARM	WARNING	
S263	Event Delay Time (sec)	10 - 9999 sec	10 sec	Smoke detected.

**Table B.2 Service Menu Alarm Settings by Line ID (continued)**

Line ID	Parameter Name	Range	Default Setting	Description
	Event Enabled	Disabled Enabled	Enabled	
	Event: SMOKE DETECTED	MESSAGE WARNING ALARM	ALARM	
S264	Event Delay Time (sec)	10 - 9999 sec	10 sec	Water under floor.
	Event Enabled	Disabled Enabled	Enabled	
	Event: WATER UNDER FLOOR	MESSAGE WARNING ALARM	ALARM	
S265	Event Delay Time (sec)	10 - 9999 sec	10 sec	Cond. pump high water.
	Event Enabled	Disabled Enabled	Enabled	
	Event: COND PUMP-HIGH WATER	MESSAGE WARNING ALARM	ALARM	
S266	Event Delay Time (sec)	0 = AR 1 = MR	0 (AR)	Loss of flow. AR = Auto Reset, MR = Manual Reset.
	Event Enabled	10 - 9999 sec	10 sec	
	Event Number 107 Enabled	Disabled Enabled	Enabled	
	Event: LOSS OF FLOW	MESSAGE WARNING ALARM	ALARM	
S267	Event Delay Time (sec)	10 - 9999 sec	10 sec	Standby glycol pump ON.
	Event Enabled	Disabled Enabled	Enabled	
	Event: STANDBY GLYCOL PUMP ON	MESSAGE WARNING ALARM	ALARM	
S268	Event Delay Time (sec)	10 - 9999 sec	10 sec	Standby unit ON.
	Event Enabled	Disabled Enabled	Enabled	
	Event: STANDBY UNIT ON	MESSAGE WARNING ALARM	ALARM	
S269	Event Delay Time (sec)	10 - 9999 sec	10 sec	Humidifier problem.
	Event Enabled	Disabled Enabled	Enabled	
	Event: HUMIDIFIER PROBLEM	MESSAGE WARNING ALARM	ALARM	
S270	Event Delay Time (sec)	10 - 9999 sec	300 sec	No connection with Unit 1.
	Event Enabled	Disabled Enabled	Enabled	
	Event: NO CONNECTION W/	MESSAGE WARNING ALARM	WARNING	

**Table B.2 Service Menu Alarm Settings by Line ID (continued)**

Line ID	Parameter Name	Range	Default Setting	Description
	UNIT1			
S271	Event Delay Time (sec)	—	—	Unit X disconnected.
	Event Enabled	Disabled Enabled	Enabled	
	Event: UNIT 01 DISCONNECTED	MESSAGE WARNING ALARM	WARNING	
S272	Event: Loss of power Autoreset Delay	60 - 3600 sec	300 sec	Loss of power.
	Event Enabled	Disabled Enabled	Enabled	
	Event: LOSS OF POWER	MESSAGE WARNING ALARM	WARNING	
S275	Event Delay Time (sec)	10 - 9999 sec	10 sec	Customer input 1.
	Event Enabled	Disabled Enabled	Enabled	
	Event: CUSTOMER INPUT 1	MESSAGE WARNING ALARM	ALARM	
S276	Event Delay Time (sec)	10 - 9999 sec	10 sec	Customer input 2.
	Event Enabled	Disabled Enabled	Enabled	
	Event: CUSTOMER INPUT 2	MESSAGE WARNING ALARM	ALARM	
S277	Event Delay Time (sec)	10 - 9999 sec	10 sec	Customer input 3.
	Event Enabled	Disabled Enabled	Enabled	
	Event: CUSTOMER INPUT 3	MESSAGE WARNING ALARM	ALARM	
S278	Event Delay Time (sec)	10 - 9999 sec	10 sec	Customer input 4.
	Event Enabled	Disabled Enabled	Enabled	
	Event: CUSTOMER INPUT 4	MESSAGE WARNING ALARM	ALARM	
S279	Event Delay Time (sec)	10 - 9999 sec	10 sec	Call service.
	Event Enabled	Disabled Enabled	Enabled	
	Event: CALL SERVICE	MESSAGE WARNING ALARM	ALARM	
S280	Event Delay Time (sec)	10 - 9999 sec	10 sec	High temperature.
	Event Enabled	Disabled Enabled	Enabled	

Table B.2 Service Menu Alarm Settings by Line ID (continued)

Line ID	Parameter Name	Range	Default Setting	Description
	Event: HIGH TEMPERATURE	MESSAGE WARNING ALARM	ALARM	
S281	Event Delay Time (sec)	10 - 9999 sec	10 sec	Loss of Air Blower 1.
	Event Enabled	Disabled Enabled	Disabled	
	Event: LOSS OF AIR BLOWER 1	MESSAGE WARNING ALARM	ALARM	
S282	Event Delay Time (sec)	10 - 9999 sec	10 sec	Reheat Lockout
	Event Enabled	Disabled Enabled	Enabled	
	Event: REHEAT LOCKOUT	MESSAGE WARNING ALARM	WARNING	
S283	Event Delay Time (sec)	10 - 9999 sec	10 sec	Humidifier lockout.
	Event Enabled	Disabled Enabled	Enabled	
	Event: HUMIDIFIER LOCKOUT	MESSAGE WARNING ALARM	WARNING	
S284	Event Delay Time (sec)	10 - 9999 sec	10 sec	FC lockout.
	Event Enabled	Disabled Enabled	Enabled	
	Event: FC LOCKOUT	MESSAGE WARNING ALARM	WARNING	
S285	Compressor Lockout Option	0 = ALL 1 = 1 (A) 2 = 2 (A) 3 = 1B 4 = 2B 5 = 1A + 2A 6 = 1B + 2B 7 = 1A + 1B 8 = 2A + 2B	0(ALL)	Compressor(s) lockout.
	Event Delay Time (sec)	10 - 9999 sec	10 sec	
	Event Enabled	Disabled Enabled	Enabled	
	Event: COMPRESSOR (S) LOCKOUT	MESSAGE WARNING ALARM	WARNING	
S27B	Edit Cust Input 1	(20 digits) 0-9 A-Z a-z &* / . + - _ : @ \	CUSTOMER INPUT 1	Edit customer input 1 text.

**Table B.2 Service Menu Alarm Settings by Line ID (continued)**

Line ID	Parameter Name	Range	Default Setting	Description
S27C	Edit Cust Input 2	(20 digits) 0-9 A-Z a-z &* / . + - _ : @ \	CUSTOMER INPUT 2	Edit customer input 2 text.
S27D	Edit Cust Input 3	(20 digits) 0-9 A-Z a-z &* / . + - _ : @ \	CUSTOMER INPUT 3	Edit customer input 3 text
S27E	Edit Cust Input 4	(20 digits) 0-9 A-Z a-z &* / . + - _ : @ \	CUSTOMER INPUT 4	Edit customer input 4 text.
S288	Event Delay Time (sec)	10 - 9999 sec	10 sec	Compressor 1 short cycle.
	Event Enabled	Disabled Enabled	Enabled	
	Event: COMP 1 SHORT CYCLE	MESSAGE WARNING ALARM	WARNING	
S289	Event Delay Time (sec)	10 - 9999 sec	10 sec	Compressor 2 short cycle.
	Event Enabled	Disabled Enabled	Enabled	
	Event: COMP 2 SHORT CYCLE	MESSAGE WARNING ALARM	WARNING	
S290	Event Delay Time (sec)	10 - 9999 sec	10 sec	Emergency power.
	Event Enabled	Disabled Enabled	Enabled	
	Event: EMERGENCY POWER	MESSAGE WARNING ALARM	WARNING	
S291	Event Delay Time (sec)	10 - 9999 sec	10 sec	Condenser 1 failure.
	Event Enabled	Disabled Enabled	Enabled	
	Event: CONDENSER 1 FAILURE	MESSAGE WARNING ALARM	WARNING	
S292	Event Delay Time (sec)	10 - 9999 sec	10 sec	Condenser 2 failure.
	Event Enabled	Disabled Enabled	Enabled	
	Event: CONDENSER 2 FAILURE	MESSAGE WARNING ALARM	WARNING	
S293	Event Delay Time (sec)	10 - 9999 sec	15 sec	EC fan fault.

**Table B.2 Service Menu Alarm Settings by Line ID (continued)**

Line ID	Parameter Name	Range	Default Setting	Description
	Event Enabled	Disabled Enabled	Enabled	
	Event: EC FAN FAULT	MESSAGE WARNING ALARM	ALARM	
S294	Event Delay Time (sec)	10 - 9999 sec	30 sec	High supply temperature.
	Event Enabled	Disabled Enabled	Enabled	
	Event: HI SUPPLY TEMPERATURE	MESSAGE WARNING ALARM	WARNING	
S295	Event Delay Time (sec)	10 - 9999 sec	30 sec	Low supply temperature.
	Event Enabled	Disabled Enabled	Enabled	
	Event: LO SUPPLY TEMPERATURE	MESSAGE WARNING ALARM	WARNING	
S296	Event Delay Time (sec)	10 - 9999 sec	10 sec	Reduced eco airflow.
	Event Enabled	Disabled Enabled	Enabled	
	Event: REDUCED ECO AIRFLOW	MESSAGE WARNING ALARM	WARNING	
S297	Event Delay Time (sec)	10 - 9999 sec	10 sec	Eco high temperature override.
	Event Enabled	Disabled Enabled	Enabled	
	Event: ECO HI TEMP OVERRIDE	MESSAGE WARNING ALARM	WARNING	
S298	Event Delay Time (sec)	10 - 9999 sec	10 sec	Temperature control sensor fail.
	Event Enabled	Disabled Enabled	Enabled	
	Event: TEMP CTRL SENSOR FAIL	MESSAGE WARNING ALARM	ALARM	
S2A2	Event Delay Time (sec)	10 - 9999 sec	30 sec	High dew point.
	Event Enabled	Disabled Enabled	Enabled	
	Event: HIGH DEW POINT	MESSAGE WARNING ALARM	WARNING	
S2A3	Event Delay Time (sec)	10 - 9999 sec	30 sec	Low dew point.
	Event Enabled	Disabled Enabled	Enabled	
	Event: LOW DEW POINT	MESSAGE WARNING ALARM	WARNING	
S2A4	Event Delay Time (sec)	10 - 9999 sec	30 sec	High dew point sensor A.

**Table B.2 Service Menu Alarm Settings by Line ID (continued)**

Line ID	Parameter Name	Range	Default Setting	Description
	Event Enabled	Disabled Enabled	Enabled	
	Event: HI DEW POINT SENSOR A	MESSAGE WARNING ALARM	WARNING	
S2A5	Event Delay Time (sec)	10 - 9999 sec	30 sec	Low dew point sensor A.
	Event Enabled	Disabled Enabled	Enabled	
	Event: LOW DEW POINT SENSOR A	MESSAGE WARNING ALARM	WARNING	
S2A6	Event Delay Time (sec)	10 - 9999 sec	30 sec	High remote sensor.
	Event Enabled	Disabled Enabled	Enabled	
	—	MESSAGE WARNING ALARM	WARNING	
S2A7	Event Delay Time (sec)	10 - 9999 sec	30 sec	Low remote sensor.
	Event Enabled	Disabled Enabled	Enabled	
	—	MESSAGE WARNING ALARM	WARNING	
S2A8	Event Delay Time (sec)	10 - 9999 sec	10 sec	Power A failure.
	Event Enabled	Disabled Enabled	Enabled	
	Event: POWER A FAILURE	MESSAGE WARNING ALARM	ALARM	
S2A9	Event Delay Time (sec)	10 - 9999 sec	10 sec	Power B failure.
	Event Enabled	Disabled Enabled	Enabled	
	Event: POWER B FAILURE	MESSAGE WARNING ALARM	ALARM	
S2B1	Event Delay Time (sec)	10 - 9999 sec	10 sec	Airflow sensor failure.
	Event Enabled	Disabled Enabled	Enabled	
	Event: AIRFLOW SENSOR FAIL	MESSAGE WARNING ALARM	WARNING	
S2B2	Event Delay Time (sec)	10 - 9999 sec	30 sec	Humidity control sensor failure.
	Event Enabled	Disabled Enabled	Enabled	
	Event: HUM CTRL SENSOR FAILURE	MESSAGE WARNING ALARM	WARNING	
S2B6	Event Delay Time (sec)	10 - 9999 sec	120 sec	Low static pressure.
	Event Enabled	Disabled Enabled	Disabled	
	Event: LOW	MESSAGE WARNING ALARM	WARNING	



**Table B.2 Service Menu Alarm Settings by Line ID (continued)**

Line ID	Parameter Name	Range	Default Setting	Description
	STATIC PRESSURE			
S2B7	Event Delay Time (sec)	10 - 9999 sec	120 sec	High static pressure.
	Event Enabled	Disabled Enabled	Disabled	
	Event: HIGH STATIC PRESSURE	MESSAGE WARNING ALARM	WARNING	
S2B8	Event Delay Time (sec)	10 - 9999 sec	150 sec	Static pressure 1 out of range.
	Event Enabled	Disabled Enabled	Disabled	
	Event: STATPR 1 OUT OF RANGE	MESSAGE WARNING ALARM	WARNING	
S2B9	Event Delay Time (sec)	10 - 9999 sec	150 sec	Static pressure 2 out of range.
	Event Enabled	Disabled Enabled	Disabled	
	Event: STATPR 2 OUT OF RANGE	MESSAGE WARNING ALARM	WARNING	
S2C1	Event Delay Time (sec)	10 - 9999 sec	150 sec	Static pressure 3 out of range.
	Event Enabled	Disabled Enabled	Disabled	
	Event: STATPR 3 OUT OF RANGE	MESSAGE WARNING ALARM	WARNING	
S2C2	Event Delay Time (sec)	10 - 9999 sec	150 sec	Static pressure 4 out of range.
	Event Enabled	Disabled Enabled	Disabled	
	Event: STATPR 4 OUT OF RANGE	MESSAGE WARNING ALARM	WARNING	
S2C3	Event Delay Time (sec)	10 - 9999 sec	120 sec	Static pressure 1 sensor failure.
	Event Enabled	Disabled Enabled	Disabled	
	Event: STAT PR 1 SENS FAIL	MESSAGE WARNING ALARM	ALARM	
S2C4	Event Delay Time (sec)	10 - 9999 sec	120 sec	Static pressure 2 sensor failure.
	Event Enabled	Disabled Enabled	Disabled	
	Event: STAT PR 2 SENS FAIL	MESSAGE WARNING ALARM	ALARM	
S2C5	Event Delay Time (sec)	10 - 9999 sec	120 sec	Static pressure 3 sensor failure.
	Event Enabled	Disabled Enabled	Disabled	
	Event: STAT PRES	MESSAGE WARNING ALARM	ALARM	

**Table B.2 Service Menu Alarm Settings by Line ID (continued)**

Line ID	Parameter Name	Range	Default Setting	Description
	3 SENS FAIL			
S2C6	Event Delay Time (sec)	10 - 9999 sec	120 sec	Static pressure 4 sensor failure.
	Event Enabled	Disabled Enabled	Disabled	
	Event: STAT PRES 4 SENS FAIL	MESSAGE WARNING ALARM	ALARM	
S2D1	Event Delay Time (sec)	10 - 9999 sec	10 sec	Compressor 1A overload.
	Event Enabled	Disabled Enabled	Enabled	
	Event: COMP 1A OVERLOAD	MESSAGE WARNING ALARM	ALARM	
S2D2	Event Delay Time (sec)	10 - 9999 sec	10 sec	Compressor 1B overload.
	Event Enabled	Disabled Enabled	Enabled	
	Event: COMP 1B OVERLOAD	MESSAGE WARNING ALARM	ALARM	
S2D3	Event Delay Time (sec)	10 - 9999 sec	10 sec	Compressor 2A overload.
	Event Enabled	Disabled Enabled	Enabled	
	Event: COMP 2A OVERLOAD	MESSAGE WARNING ALARM	ALARM	
S2D4	Event Delay Time (sec)	10 - 9999 sec	10 sec	Compressor 2B overload.
	Event Enabled	Disabled Enabled	Enabled	
	Event: COMP 2B OVERLOAD	MESSAGE WARNING ALARM	ALARM	
S2D5	Event Delay Time (sec)	10 - 9999 sec	10 sec	Compressor 1A high temperature.
	Event Enabled	Disabled Enabled	Enabled	
	Event: COMP 1A HIGH TEMP	MESSAGE WARNING ALARM	ALARM	
S2D6	Event Delay Time (sec)	10 - 9999 sec	10 sec	Compressor 1B high temperature.
	Event Enabled	Disabled Enabled	Enabled	
	Event: COMP 1B HIGH TEMP	MESSAGE WARNING ALARM	ALARM	
S2D7	Event Delay Time (sec)	10 - 9999 sec	10 sec	Compressor 2A high temperature.
	Event Enabled	Disabled Enabled	Enabled	

**Table B.2 Service Menu Alarm Settings by Line ID (continued)**

Line ID	Parameter Name	Range	Default Setting	Description
	Event: COMP 2A HIGH TEMP	MESSAGE WARNING ALARM	ALARM	
S2D8	Event Delay Time (sec)	10 - 9999 sec	10 sec	Compressor 2B high temperature.
	Event Enabled	Disabled Enabled	Enabled	
	Event: COMP 2B HIGH TEMP	MESSAGE WARNING ALARM	ALARM	
S2D9	Event Delay Time (sec)	10 - 9999 sec	10 sec	Compressor 1A short cycle.
	Event Enabled	Disabled Enabled	Enabled	
	Event: COMP 1A SHORT CYCLE	MESSAGE WARNING ALARM	WARNING	
S2E1	Event Delay Time (sec)	10 - 9999 sec	10 sec	Compressor 1B short cycle.
	Event Enabled	Disabled Enabled	Enabled	
	Event: COMP 1B SHORT CYCLE	MESSAGE WARNING ALARM	WARNING	
S2E2	Event Delay Time (sec)	10 - 9999 sec	10 sec	Compressor 2A short cycle.
	Event Enabled	Disabled Enabled	Enabled	
	Event: COMP 2A SHORT CYCLE	MESSAGE WARNING ALARM	WARNING	
S2E5	Event Delay Time (sec)	10 - 9999 sec	10 sec	Compressor 2B short cycle.
	Event Enabled	Disabled Enabled	Enabled	
	Event: COMP 2B SHORT CYCLE	MESSAGE WARNING ALARM	WARNING	
S2E6	Event Delay Time (sec)	10 - 9999 sec	60 sec	GCB ambient temperature differential.
	Event Enabled	Disabled Enabled	Enabled	
	Event: GCD AMBIENT TEMP DIFF	MESSAGE WARNING ALARM	WARNING	
S2E7	—	—	—	C1 freeze protection.
	Event Enabled	Disabled Enabled	Enabled	
	Event: C1 FREEZE PROTECTION	MESSAGE WARNING ALARM	ALARM	

**Table B.2 Service Menu Alarm Settings by Line ID (continued)**

Line ID	Parameter Name	Range	Default Setting	Description
S2E8	—	—	—	C2 freeze protection.
	Event Enabled	Disabled Enabled	Enabled	
	Event: C2 FREEZE PROTECTION	MESSAGE WARNING ALARM	ALARM	
S2E9	Event Delay Time (sec)	10 - 9999 sec	10 sec	Damper failure.
	Event Enabled	Disabled Enabled	Enabled	
	Event: DAMPER FAILURE	MESSAGE WARNING ALARM	ALARM	
SF2F	—	—	—	BMS disconnected.
	Event Enabled	Disabled Enabled	Enabled	
	Event: BMS DISCONNECTED	MESSAGE WARNING ALARM	WARNING	
S2F9	Phase Loss MB01 shuts unit down	0 = No 1 = Yes	1 (Yes)	Power 1 phase loss.
	Event Delay Time (sec)	10 - 9999 sec	10 sec	
	Event Enabled	Disabled Enabled	Enabled	
	Event: POWER 1 PHASE LOSS	MESSAGE WARNING ALARM	ALARM	
S2G1	Phase Loss MB02 shuts unit down	0 = No 1 = Yes	1 (Yes)	Power 2 phase loss.
	Event Delay Time (sec)	10 - 9999 sec	10 sec	
	Event Enabled	Disabled Enabled	Enabled	
	Event: POWER 2 PHASE LOSS	MESSAGE WARNING ALARM	ALARM	
S2G2	Phase Loss MB03 shuts unit down	0 = No 1 = Yes	1 (Yes)	Power 3 phase loss.
	Event Delay Time (sec)	10 - 9999 sec	10 sec	
	Event Enabled	Disabled Enabled	Enabled	
	Event: POWER 3 PHASE LOSS	MESSAGE WARNING ALARM	ALARM	
S2G3	Phase Loss MB04 shuts unit down	0 = No 1 = Yes	1 (Yes)	Power 4 phase loss.
	Event Delay Time (sec)	10 - 9999 sec	10 sec	
	Event Enabled	Disabled Enabled	Enabled	

Table B.2 Service Menu Alarm Settings by Line ID (continued)

Line ID	Parameter Name	Range	Default Setting	Description
	Event: POWER 4 PHASE LOSS	MESSAGE WARNING ALARM	ALARM	
S2G4	Phase Loss MB05 shuts unit down	0 = No 1 = Yes	1 (Yes)	Power 5 phase loss.
	Event Delay Time (sec)	10 - 9999 sec	10 sec	
	Event Enabled	Disabled Enabled	Enabled	
	Event: POWER 5 PHASE LOSS	MESSAGE WARNING ALARM	ALARM	
S2G5	Phase Loss MB06 shuts unit down	0 = No 1 = Yes	1 (Yes)	Power 6 phase loss.
	Event Delay Time (sec)	10 - 9999 sec	10 sec	
	Event Enabled	Disabled Enabled	Enabled	
	Event: POWER 6 PHASE LOSS	MESSAGE WARNING ALARM	ALARM	
S2G6	Event Delay Time (sec)	10 - 9999 sec	60 sec	Flow sensor fail C1.
	Event Enabled	Disabled Enabled	Enabled	
	Event: FLOW SENSOR FAIL C1	MESSAGE WARNING ALARM	WARNING	
S2G7	Event Delay Time (sec)	10 - 9999 sec	60 sec	Flow sensor fail C2.
	Event Enabled	Disabled Enabled	Enabled	
	Event: FLOW SENSOR FAIL C2	MESSAGE WARNING ALARM	WARNING	
S2G8	Event Delay Time (sec)	10 - 9999 sec	60 sec	TSA sensor fail.
	Event Enabled	Disabled Enabled	Enabled	
	Event: TSA SENSOR FAIL	MESSAGE WARNING ALARM	ALARM	
617	Event Delay Time (sec)	1 - 9999 sec	10 sec	XDU pump inverter fail 1.
	Event Enabled	Disabled Enabled	Enabled	
	Event: PUMP INVERTER FAIL 1	MESSAGE WARNING ALARM	ALARM	
618	Event Delay Time (sec)	1 - 9999 sec	10 sec	XDU pump inverter fail 2.
	Event Enabled	Disabled Enabled	Enabled	
	Event: PUMP INVERTER FAIL 2	MESSAGE WARNING ALARM	ALARM	

**Table B.2 Service Menu Alarm Settings by Line ID (continued)**

Line ID	Parameter Name	Range	Default Setting	Description
619	Event Delay Time (sec)	1 - 9999 sec	10 sec	XDU pump flow fail 1.
	Event Enabled	DisabledEnabled	Enabled	
	Event: PUMP FLOW FAIL 1	MESSAGEWARNINGALARM	ALARM	
620	Event Delay Time (sec)	1 - 9999 sec	10 sec	XDU pump flow fail 2.
	Event Enabled	DisabledEnabled	Enabled	
	Event: PUMP FLOW FAIL 2	MESSAGEWARNINGALARM	ALARM	
621	Event Delay Time (sec)	1 - 9999 sec	10 sec	XDU fluid flow check filter.
	Event Enabled	DisabledEnabled	Enabled	
	Event: CHECK WATER SYSTEM	MESSAGEWARNINGALARM	WARNING	
622	Event Delay Time (sec)	1 - 9999 sec	10 sec	The current XDU supply fluid temperature is above the threshold.
	Event Enabled	DisabledEnabled	Enabled	
	Event: HIGH SUPPLY WATER TEMP	MESSAGEWARNINGALARM	WARNING	
623	Event Delay Time (sec)	1 - 9999 sec	10 sec	The current XDU return fluid temperature is above the threshold.
	Event Enabled	DisabledEnabled	Enabled	
	Event: HIGH RETURN WATER TEMP	MESSAGEWARNINGALARM	WARNING	
624	Event Delay Time (sec)	1 - 9999 sec	10 sec	XDU pump operation with no flow.
	Event Enabled	DisabledEnabled	Enabled	
	Event: PUMP OPERATION WITH NO FLOW	MESSAGEWARNINGALARM	ALARM	
625	Event Delay Time (sec)	1 - 9999 sec	10 sec	XDU supply fluid sensor failure.
	Event Enabled	DisabledEnabled	Enabled	
	Event: SUPPLY FLUID SENSOR FAILURE	MESSAGEWARNINGALARM	ALARM	
626	Event Delay Time (sec)	1 - 9999 sec	10 sec	XDU return fluid sensor failure.

Table B.2 Service Menu Alarm Settings by Line ID (continued)

Line ID	Parameter Name	Range	Default Setting	Description
	Event Enabled	DisabledEnabled	Enabled	
	Event: RETURN FLUID SENSOR FAILURE	MESSAGEWARNINGALARM	ALARM	
627	Event Delay Time (sec)	1 - 9999 sec	10 sec	XDU fluid flow sensor failure.
	Event Enabled	DisabledEnabled	Enabled	
	Event: FLOW SENSOR FAILURE	MESSAGEWARNINGALARM	ALARM	
628	Event Delay Time (sec)	1 - 9999 sec	-	Current working hours of fluid pump 1 are above the threshold.
	Event Enabled	DisabledEnabled	Enabled	
	Event: PUMP 1 HOURS EXCEEDED	MESSAGEWARNINGALARM	WARNING	
629	Event Delay Time (sec)	1 - 9999 sec	-	Current working hours of fluid pump 2 are above the threshold
	Event Enabled	DisabledEnabled	Enabled	
	Event: PUMP 2 HOURS EXCEEDED	MESSAGEWARNINGALARM	WARNING	

### B.3 Line IDs for Cascade Operation Parameters

Table B.3 Service Menu Cascade Parameters by Line ID

Line ID	Parameter Name	Range	Default Setting	Description
S515	Cascade Units	No Yes Cool/Heat Cooling Fan PI Fan Speed	No	User may select the method to which the next standby unit will stage ON. <ul style="list-style-type: none"> <li>No: Disabled</li> <li>Yes: Enabled via TW Mode 1</li> <li>Cool/Heat: Enabled via TW Mode 1</li> <li>Cooling: Enabled via TW Mode 1</li> <li>Fan PI: Enabled via TW Mode 3</li> <li>Fan Speed : Enabled via TW Mode 3</li> </ul>
S516	Cascaded Units Delay	0 - 30 min	10 min	This is the amount of time that must surpass prior to the standby unit staging ON, once a standby unit receives an ON command from the Master (U2U 1).
S517	Cascaded Units Quick Start	0 - 30 min	2 min	This control delay time is used (shorter time than S516) after the Master (U2U 1) has restarted after a power cycle. The timer changes back to using S516 when the time of power cycle is equal to S517 min/sec.
	Cascaded Units QS Delay	15 - 1800 sec	120 sec	<b>NOTE: This setting is not required. If set to a value of 0, then S517 Cascade Units Quick Start is disabled.</b>

**Table B.3 Service Menu Cascade Parameters by Line ID (continued)**

Line ID	Parameter Name	Range	Default Setting	Description
S518	Cascaded Units Control Delay	0 - 30 min	5 min	This is the amount of time that must surpass before the normal unit control is used once a standby unit has been cascaded ON.
S519	Cascaded Units OFF Delay	0 - 360 min	0 min	This timer starts to count down once a cascaded ON system has received an OFF request from the master. The cascaded unit will stop after this timer and S520 have elapsed.
S520	Cascaded Units Min Run	2 - 360 min	30 min	Once the cascaded system is energized, this is the minimum ON time that it will run before staging OFF.
S521	Start Next Unit at SYS Fanspeed	50 - 100%	100%	When the system (network) fan speed operates at or above S521, the S516 timer is started. Once S516 has elapsed, the next single unit will energized. <b>NOTE: Fan speed must be continuously at or above the value set in S521, The timer restarts any time the fan speed falls below.</b>
S522	Max. Intermediate System Speed	50 - 100 %	100%	Defines the value to which the system (network) fan speed may increase when not all units in the network are in operation.
S523	Stop Next Unit SYS Fanspeed	20 - 70 %	70%	When the current System (network) fan speed operates at or below S523, two timers must elapse before the cascaded ON unit turns OFF; S519 and S520.
S524	Cascaded Units OFF Master Delay	0 - 360 min	1 min	In the event that the Virtual Master takes control, the new Master unit shall control staging OFF of the currently operating units for the amount of time set in S524. After S524 time has elapsed, S519 value is used.



## Appendix C: Communication Protocol

Table C.1 Communication Protocols

Communication Protocol (A through H)										
Third-Party Protocols (B through H)										
Communication Card	LIFE Services Support	Sensor Support	A HTTP/HTTPS	B Velocity Protocol	C Email	D SMS	E SNMP v1, v2, v3	F BACnet IP/MSTP	G MODBUS TCP/RTU	H YDN23
IS-UNITY-DP	✓	✓	✓	✓	✓	✓	✓	✓	✓	NXL, EXL-S1 & PEX
IS-UNITY-SNMP	✓	–	✓	✓	✓	✓	–	–	–	–
EMBEDDED UNITY	✓	–	✓	✓	✓	✓	✓	✓	✓	–
IS-UNITY-LIFE <sup>2</sup>	✓	✓	✓	✓	✓	✓	–	–	–	–
RDU101	✓	✓	✓	✓	✓	✓	✓	✓ <sup>1</sup>	✓ <sup>1</sup>	–
SN-Sensor Support	–	–	✓	✓	✓	✓	✓	–	–	–

<sup>1</sup> Please note that BACnet MSTP and Modbus RTU require P/N USB4851, a USB to RS-485 adapter.

<sup>2</sup> The IS-UNITY-LIFE card cannot be ordered. It is provided to customers free of charge as part of a Remote Service Delivery contract.

This page intentionally left blank

### **Connect with Vertiv on Social Media**



<https://www.facebook.com/vertiv/>



<https://www.instagram.com/vertiv/>



<https://www.linkedin.com/company/vertiv/>



<https://www.twitter.com/Vertiv/>



---

Vertiv.com | Vertiv Headquarters, 505 N. Cleveland Ave., Westerville, OH 43082, USA

© 2024 Vertiv Group Corp. All rights reserved. Vertiv™ and the Vertiv logo are trademarks or registered trademarks of Vertiv Group Corp. All other names and logos referred to are trade names, trademarks or registered trademarks of their respective owners. While every precaution has been taken to ensure accuracy and completeness here, Vertiv Group Corp. assumes no responsibility, and disclaims all liability, for damages resulting from use of this information or for any errors or omissions.

SL-31075\_REV9\_04-24