



**DISCONTINUED
PRODUCT**

POWER AVAILABILITY

POWERSURE™ PSP

USER MANUAL



**350-650 VA
120V**



**DISCONTINUED
PRODUCT**

TABLE OF CONTENTS

IMPORTANT SAFETY INSTRUCTIONS	1
INTRODUCTION & SYSTEM DESCRIPTION	4
Front View of UPS	5
Rear View of UPS	6
MAJOR COMPONENTS	7
Transient Voltage Surge Suppression (TVSS) & EMI / RFI Filters	7
Transfer Switch	7
Battery Charger	7
Battery	7
Inverter	7
WHAT'S INCLUDED	8
INSTALLATION	9
CONTROLS AND INDICATORS	11
ON/OFF/Alarm Silence Button	11
Status Indicators: Fault, Utility, Battery	12
Utility Indicator (Green)	12
Battery Indicator (Green/Amber)	12
Fault Indicator (Red/Green)	12
Location and Status of Indicators	12
Site Wiring Fault Indicator (Red)	13
Transfer Voltage Selectors (DIP Switches)	13
MODES OF OPERATION	14
Normal Mode	14
Battery Mode	15
COMMUNICATIONS	16
DB-9 Connector	16
Remote Shutdown Via the DB-9 Connector	17
Shutdown Via Pins 5 & 6	17
Shutdown Via Pins 4 & 5	17
USB Interface Port	17
Data Line Protection Connectors	17

MAINTENANCE	18
Cleaning the UPS.	18
Maintaining Batteries	18
Battery Replacement	18
Battery Replacement Procedure	19
TROUBLESHOOTING	20
Guide to Status Indicators.	20
Troubleshooting Chart.	21
SPECIFICATIONS	22
Battery Run Times.	23
Product Warranty Registration.	23

IMPORTANT SAFETY INSTRUCTIONS

SAVE THESE INSTRUCTIONS

This manual contains important safety instructions that should be followed during the installation and maintenance of the Uninterruptible Power System (UPS) and its batteries. Please read this manual thoroughly before attempting to install or operate this UPS.

Read all safety, installation, and operating instructions before operating the UPS. Adhere to all warnings on the unit and in this manual. Follow all operating and user instructions.

This equipment is designed for Commercial, Industrial or Residential use. Liebert Corporation neither recommends nor knowingly sells this product for use in life support applications or with other designated critical devices.



WARNING

SAFETY PRECAUTIONS

- To prevent the risk of fire or electric shock, install the UPS in a temperature and humidity controlled room, free of conductive contaminants, moisture, flammable liquids, gases and corrosive substances.
- Operate the UPS only from a properly grounded (earthed) 110-127 VAC, 50Hz or 60Hz AC supply.
- To reduce the risk of electric shock, do not remove the cover, as it has no user-serviceable parts inside except the internal battery pack. Some components are live, even when AC power is disconnected. For service, contact a qualified technician.



CAUTION

Although your UPS has been designed and manufactured to assure personal safety, improper use can result in electrical shock or fire. To ensure safety, please observe the following rules:

- Turn off and unplug your UPS before cleaning. Do not use liquid or aerosol cleaners. A dry cloth is recommended to remove dust from the surface of your UPS.
- Do not install or operate your UPS in or near water.
- Do not place UPS on an unstable cart, stand, or table.
- Do not place UPS under direct sunlight or close to heat emitting sources.
- Never block or insert any objects into the ventilation holes or other openings of the UPS. Keep all vents free of dust accumulation that could restrict air flow.
- Do not place UPS power cord in any area where it may get damaged by heavy objects.



WARNING

If your UPS demonstrates any of the following conditions, turn off and unplug your UPS from the outlet and contact your local dealer, Liebert representative or Liebert Worldwide Support Group:

- The power cord or plug is damaged.
- Liquid has been spilled on the UPS.
- The circuit protector trips frequently.
- The UPS does not operate in accordance with the user manual.

CONDITIONS OF USE: The input receptacle must be within 6 feet (1.8 meters) of the UPS.

Your UPS provides conditioned power to connected equipment. Maximum load must not exceed that shown on UPS rating label. If uncertain, consult your local dealer, Liebert representative or the Liebert Worldwide Support Group.

Placing magnetic storage media on top of the UPS may result in data corruption.

The equipment can be installed and operated by individuals without previous training.



CAUTION

DO NOT CONNECT equipment that could overload the UPS or demand half-wave rectification from the UPS, for example: electric drills, vacuum cleaners, inkjet printers, hair dryers.

Inkjet printers, scanners and fax machines that do not exceed the capacity of the UPS may be plugged into either of the two (2) black surge-protected receptacles. **NEVER** connect these types of machines to any of the orange battery backed up receptacles.



CAUTION

BATTERY HANDLING PRECAUTIONS

Servicing of batteries should be performed or supervised by personnel knowledgeable of batteries and required precautions. Keep unauthorized personnel away from the batteries.

A battery can present a risk of electrical shock and high short-circuit current. The following precautions should be observed when working on batteries:

- Remove watches, rings, and other metal objects.
- Use tools with insulated handles.
- Do not dispose battery or batteries in a fire. The battery may explode.
- Do not open or mutilate the battery or batteries. Released electrolyte is harmful to skin and eyes. It may be toxic.
- When replacing the battery, use same number and type of battery as the suitable recommended type of battery listed in specification table in back of this manual.
- Handle, transport and recycle batteries in accordance with local regulations.



NOTE

This device complies with part 15 of the FCC Rules.

Operation is subject to the following two conditions: (1) This device may not cause harmful interference, and (2) this device must accept any interference received, including interference that may cause undesired operation.

This equipment uses, generates and can radiate radio frequency energy and, if not installed and used in accordance with the instructions, may cause harmful interference with radio communications. However, there is no guarantee that interference will not occur in a particular installation.

If this equipment does cause harmful interference to radio or television reception, which can be determined by turning the equipment off and on, the user is encouraged to try to correct the interference by one or more of the following measures:

- *Reorient or relocate the receiving antenna.*
- *Increase the separation between the UPS and the receiver.*
- *Connect the UPS into an outlet on a circuit different from the one on which the receiver is connected.*

INTRODUCTION & SYSTEM DESCRIPTION

Congratulations on your choice of the Liebert PowerSure™ PSP Uninterruptible Power System (UPS). It provides filtered AC power to sensitive electronic equipment and other critical loads.

The PowerSure PSP is an off-line UPS designed for desktop applications. It provides perfect one-to-one power protection for electronic equipment such as PCs, point-of-sale displays, home office equipment and similar electronic gear. The PowerSure PSP is available in three (3) sizes: 350, 500 and 650VA at 120VAC. The configurable input power selector switch offers the user a wide input voltage window.

In the absence of utility power, the UPS supplies connected equipment with a stepped sinewave.

Front View of UPS

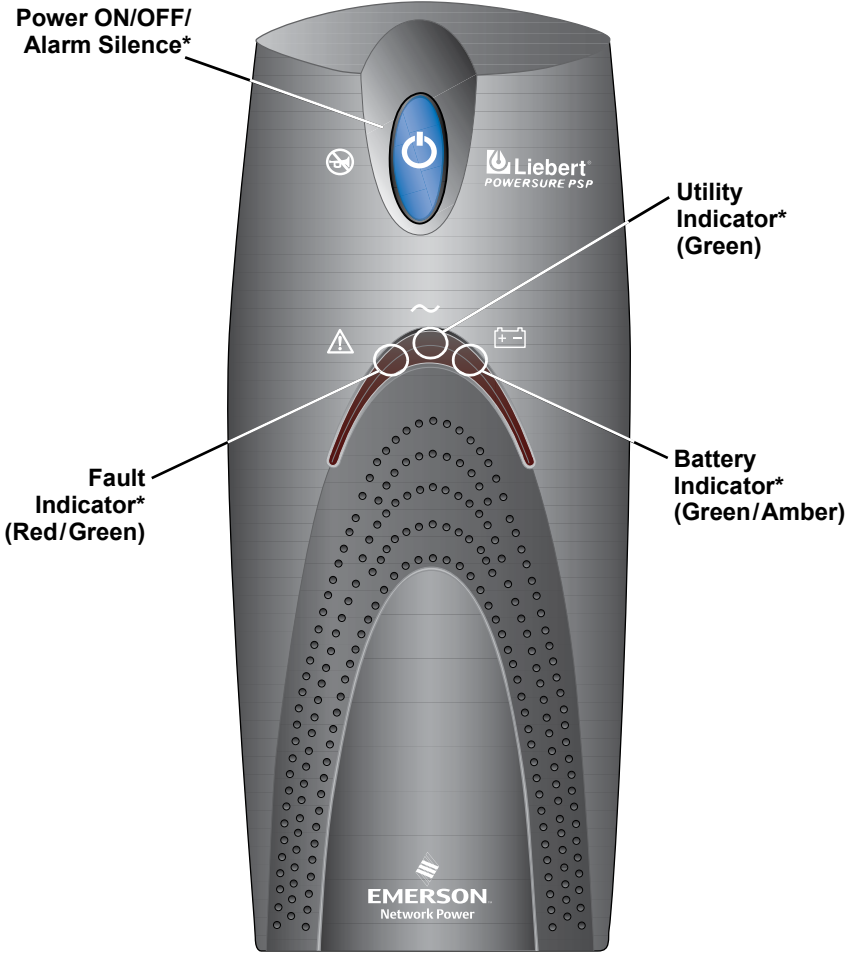

* For details, see
Controls and Indicators
section

Rear View of UPS

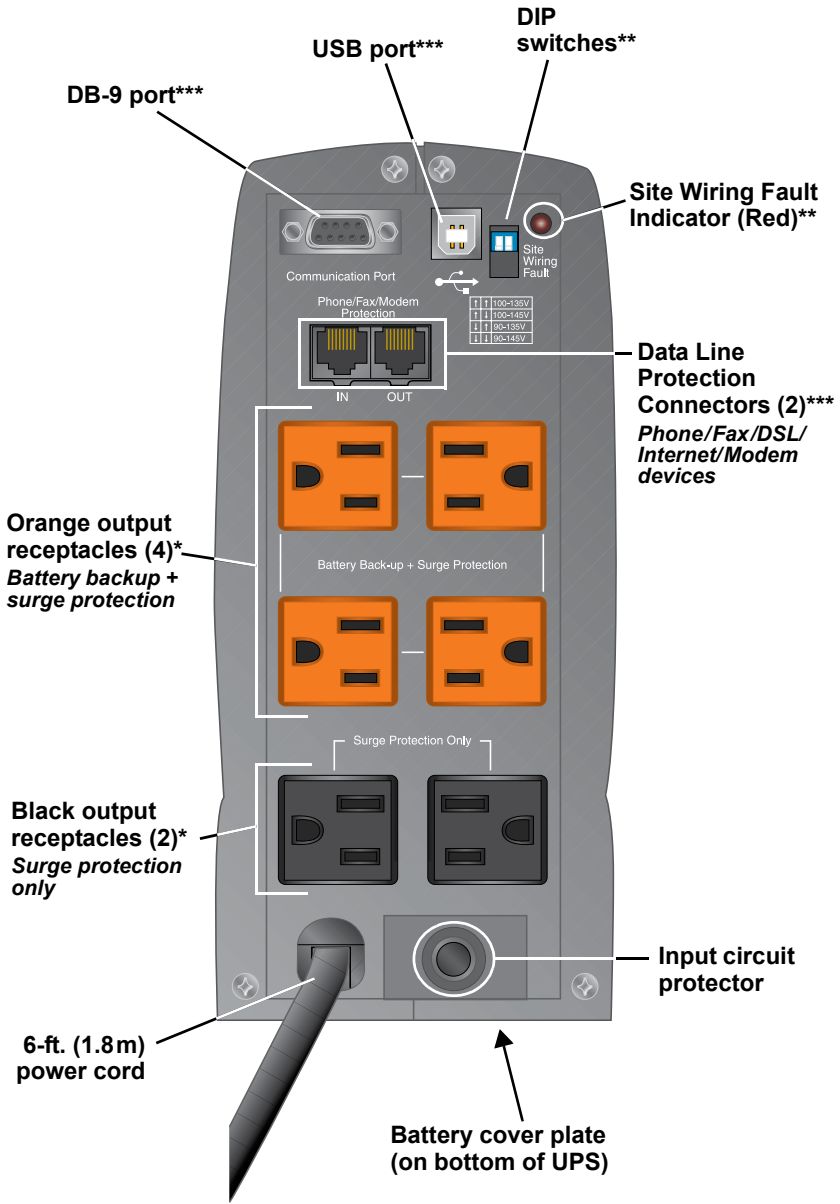

For details, see:
* Installation section
** Controls and Indicators section
*** Communications section

MAJOR COMPONENTS

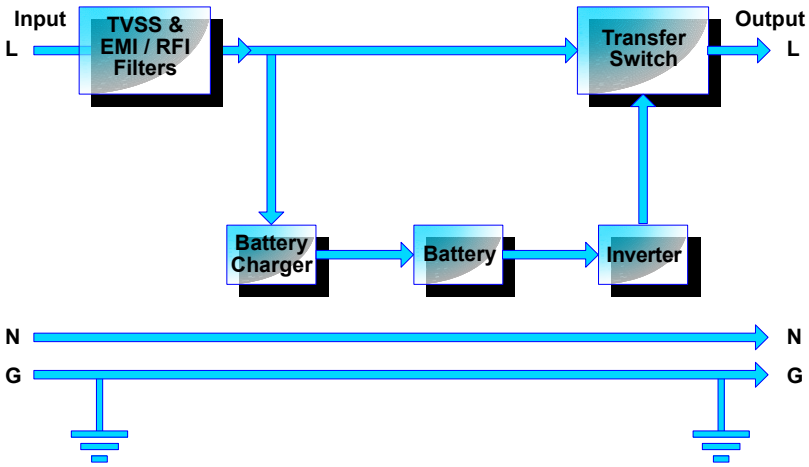

Transient Voltage Surge Suppression (TVSS) & EMI / RFI Filters

These UPS components provide surge protection and filter electromagnetic interference (EMI) and radio frequency interference (RFI). They minimize surges or interference present in the utility line and keep the sensitive equipment protected.

Transfer Switch

In Normal mode the Transfer Switch passes utility AC power to the connected load. When input utility or frequency is outside acceptable limits, the transfer switch activates and transfers the UPS to battery.

Battery Charger

In Normal mode, the Battery Charger converts utility AC power into regulated DC power to float charge the battery. It is continuously charging the battery whenever the UPS is plugged into a power outlet and utility power is within acceptable limits—even if the UPS is turned OFF.

Battery

The PowerSure PSP utilizes a valve-regulated, nonspillable, lead acid battery. To optimize battery life, operate the UPS in an ambient temperature of 68°-77°F (20°-25°C).

Inverter

When utility power fails, the Inverter draws energy from the battery and inverts it into a regulated stepped sinewave supplying power for equipment connected to the orange receptacles.

WHAT'S INCLUDED

The PowerSure PSP is shipped with the following components:

- Quick-Start guide
- PowerSure family user manual on CD
- Warranty card
- MultiLink™ software CD
- MultiLink serial cable (M3LS9P9S), 10 ft. (3m)
- RJ-11 cord, 7 ft. (2.1 m)
- USB cable, 6 ft. (1.8m)



**PowerSure
PSP**

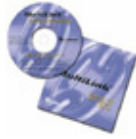

**MultiLink
software CD**



**MultiLink
serial cable
(M3LS9P9S)
10 ft. (3m)**



**RJ-11 cord
7 ft. (2.1m)**



**USB cable
6 ft. (1.8m)**

INSTALLATION

1. Visually inspect the UPS for freight damage. Report damage to the carrier and your local dealer, Liebert representative or the Liebert Worldwide Support Group.
2. Decide where to place the PowerSure PSP. Install the UPS indoors in a controlled environment, where it cannot be accidentally turned off. Place it in an area of unrestricted airflow around the unit, away from water, flammable liquids, gases, corrosives, and conductive contaminants. Maintain a minimum clearance of 4 inches (100mm) on each side of the UPS. Maintain an ambient temperature range of 32°F to 104°F (0°C to 40°C).



NOTE

UPS operation in temperatures above 77°F (25°C) reduces battery life.

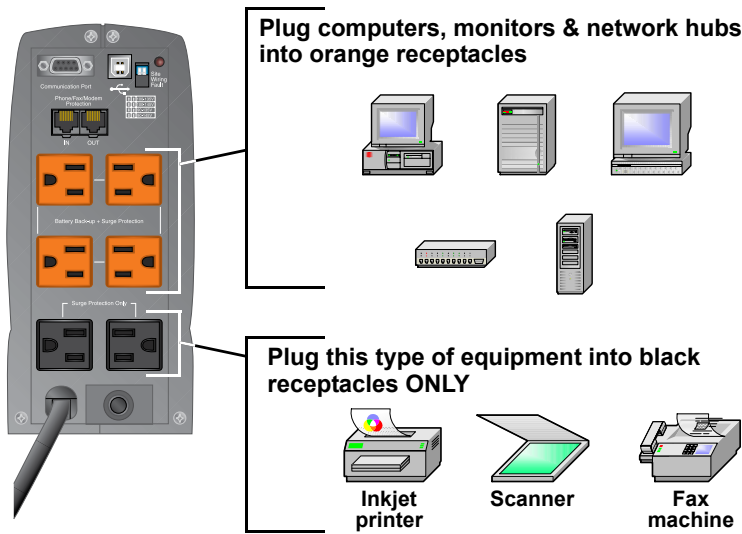

3. Plug the PowerSure PSP's attached 6-ft. (1.8m) power cord into an AC outlet. Check that the Site Wiring Fault Indicator on the rear is not illuminated. If lit, refer to the **Troubleshooting** section.
4. Plug any computers and monitors into the orange battery backed up receptacles.

Other office machines that do not exceed the capacity of the UPS—inkjet printers, scanners and fax machines—may be plugged into either of the two (2) black receptacles, which provide surge protection only.

-
5. Connect Phone/Fax/DSL/Internet/Modem devices to data line connectors.

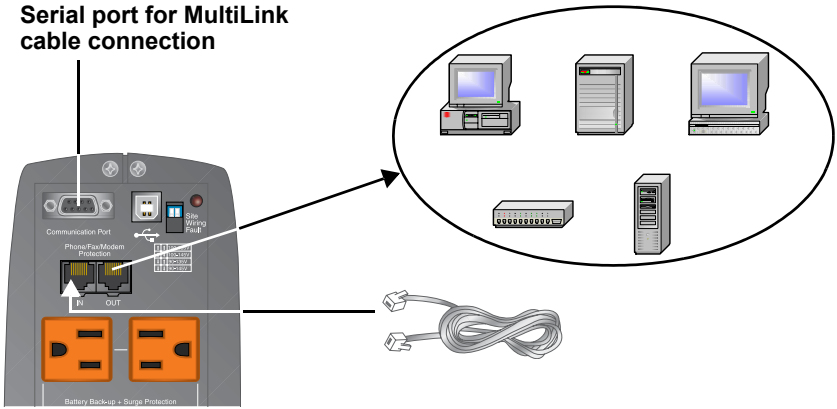

6. Press and release the ON/OFF/Alarm Silence button to turn on the UPS. The UPS will beep and the Utility Indicator will illuminate (green).
7. Turn on connected equipment.
8. Communication options (see **Communications** section for details):

Option 1—Serial Communications

Serial communications provides parametric data, for example, input voltage and battery voltage.

- a. Connect Multilink serial cable included with the UPS to communications port.
- b. Install the MultiLink software—the software and installation instructions, as well as the user manual, are on the CD included in the PowerSure PSP package.

Option 2—Contact Closure Communications

Contact Closure communications provides on-battery and low-battery signals for orderly shutdown.

- a. Refer to the MultiLink user manual for instructions on making your own contact closure cable.
- b. Install the MultiLink software—the software and installation instructions, as well as the user manual, are on the CD included in the PowerSure PSP package.

Option 3—USB Communications

- a. Connect USB cable provided with the UPS to the USB ports on the PSP and your computer. The PSP will work automatically with your built-in power management software on Windows XP and 2000 and Mac OS 10.2 or later (see **USB Interface Port** section for details).

CONTROLS AND INDICATORS

ON/OFF/Alarm Silence Button



This button controls output power to the connected load and has three functions:

- ON
- OFF
- Alarm Silence



ON/OFF/Alarm Silence

ON When the UPS is off, pressing and releasing the main ON/OFF button will start the UPS, and an audible alarm sounds briefly. The UPS is capable of starting on battery (*battery start*).

OFF When the UPS is on (in either Normal or Battery mode), pressing the main ON/OFF button for **more than two (2) seconds** will shut down the UPS. An audible alarm sounds briefly.

Alarm Silence When a UPS alarm is active, pressing and releasing the main ON/OFF button will silence the active audible alarm, whether utility power is present or not. Once the alarm silence function has been activated, all active audible alarms—except for low battery, overload, or over-temperature conditions—will remain silenced until a new alarm condition is detected.



NOTE

*Do not hold ON/OFF button down for **more than 2 seconds** or the UPS will shut down.*

Status Indicators: Fault, Utility, Battery

There are three (3) status indicators on the front of the UPS (Utility, Battery and Fault), as shown in the diagram below. Each indicator illuminates to specify the status of the UPS (see **Troubleshooting** section for details).

Utility Indicator (Green)

The Utility Indicator illuminates green when the UPS is operating and supplying power to connected loads.

Battery Indicator (Green/Amber)

The Battery Indicator illuminates to indicate the UPS is operating on battery (green) or to signify a battery warning (amber).

Fault Indicator (Red/Green)

The Fault Indicator illuminates when the UPS detects a problem: red for an internal UPS fault, green for overload and over-temperature conditions.

Location and Status of Indicators

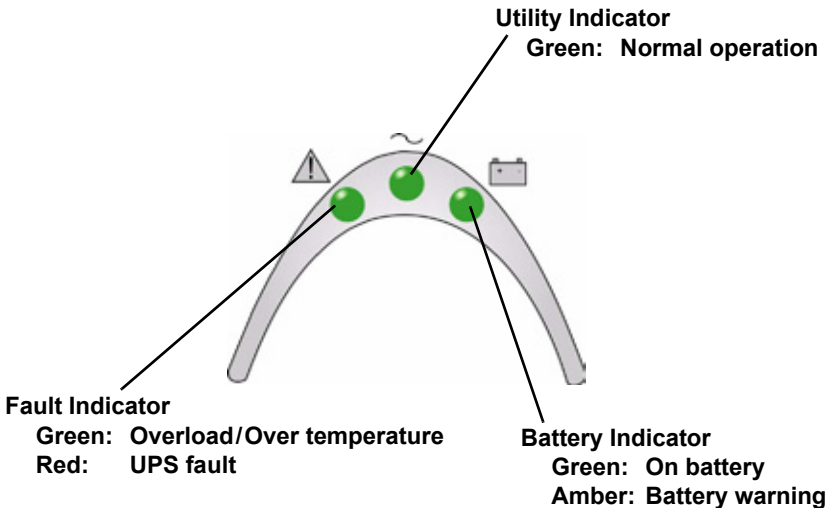

NOTE

See **Troubleshooting** section for details.

Site Wiring Fault Indicator (Red)

The Site Wiring Fault Indicator on the rear panel, as shown below, illuminates red when the UPS detects a line-neutral reversal or a poor neutral-ground. (Refer to **Troubleshooting Chart** if this indicator is illuminated.)

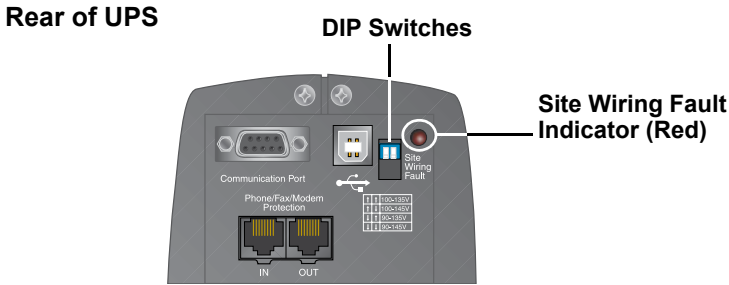

Transfer Voltage Selectors (DIP Switches)

The two-position DIP switch control on the rear panel, as shown above, allows the operator to select the utility transfer voltage at which the UPS will switch to battery power. The factory default settings are 100VAC - 135VAC. DIP switch positions for each voltage setting are as follows:

DIP switch settings			
Left	Right	Nominal Utility	Setting
↑ Up	↑ Up	120VAC	100 - 135VAC (default)
↑ Up	↓ Down	110VAC	100 - 145VAC
↓ Down	↑ Up	127VAC	90 - 135VAC
↓ Down	↓ Down	120VAC	90 - 145VAC



CAUTION

Never change the voltage settings while the UPS is ON and powering connected loads. Change DIP switches only when the UPS is OFF.



CAUTION

To ensure protection of the connected equipment, the DIP switch settings should match the nominal utility input voltage. DIP switch settings not matching the nominal utility could potentially damage connected equipment.

MODES OF OPERATION

Normal Mode

During Normal mode operation, the PowerSure PSP supplies conditioned, computer-grade power to the connected equipment: utility power passes through the EMI/RFI filters and TVSS circuitry and then through the Transfer Switch to the connected equipment.

When the UPS is in Normal mode, the Utility Indicator illuminates green.

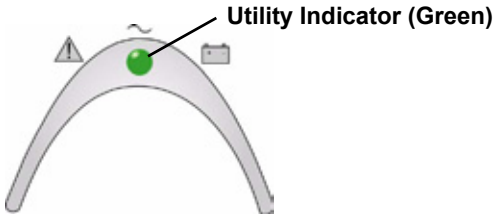

The PowerSure PSP continuously monitors the batteries to maintain them in a fully charged state. The battery charger operates whenever AC power is present, even if the UPS is switched off. By default, the UPS is set to perform an automatic battery test after it has been operating continuously for two (2) weeks. The interval at which the UPS performs a battery test can be configured via MultiLink.

Battery Mode

The UPS switches to Battery mode in the event of an extreme voltage/frequency condition or complete utility failure. The battery system supplies power through the Inverter to generate power for the connected equipment.

When the UPS is in Battery mode, the Battery Indicator illuminates green and an alarm sounds every 10 seconds.

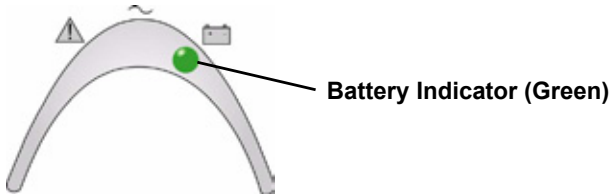

When a low battery condition occurs, the Battery Indicator changes to flashing amber and the alarm sounds every half-second. Low battery warning is defaulted to two (2) minutes but can be configured via MultiLink. For more information, refer to **Troubleshooting** section.

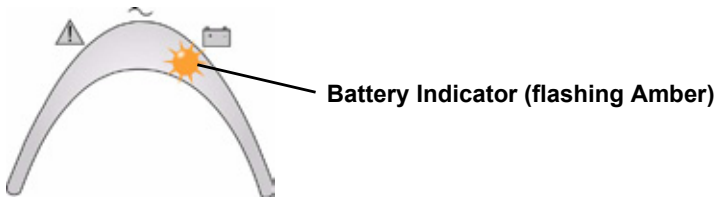

CAUTION

Turning off the UPS while in either Normal mode or Battery mode will result in the loss of output power.



NOTE

Once utility power is restored, the UPS resumes normal operation. At this time, the battery charger begins recharging the battery. The UPS is capable of OFF-State charging, i.e., with utility power, the UPS will charge the batteries as long as it is plugged in.

COMMUNICATIONS

DB-9 Connector

The UPS has a DB-9 (9 pin female) connector on the rear to allow UPS status communications with a computer system running MultiLink™ software. The DB-9 is capable of supplying serial communication, on battery and low battery signals. MultiLink, Liebert's UPS monitoring and shutdown software, is shipped with the UPS, along with a 10-ft. (3m) DB-9 cable required for running MultiLink.

When MultiLink is installed on the host computer, the UPS can signal "on battery" and "low battery" using opto-couplers. When the UPS is operating in Battery mode, it can receive a signal from the host computer system that will shut down the UPS (after gracefully shutting down the operating system on the host computer system) when the remaining battery run time is low. The timing of the signal depends on MultiLink's configuration settings. This shutdown signal (5-12VDC) must have a duration of at least 2 seconds for the UPS to be shut down. The UPS communicates via serial communications using Liebert ESP II protocol.

DB-9 Pin	Assignment Description
1	Low Battery (open collector)
2	UPS TxD (typical RS-232 levels)
3	UPS RxD (typical RS-232 levels)
4	Battery Mode Shutdown (5-12VDC, 10-24 mA max)
5	Common
6	Any Mode Shutdown (short to Pin 5)
7	Low Battery (open emitter)
8	Utility Fail (open emitter)
9	Utility Fail (open collector)

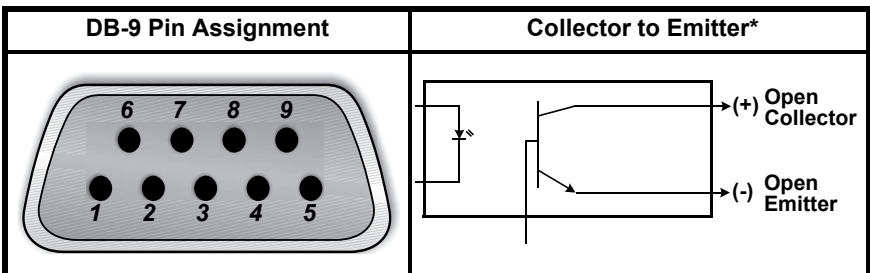

* Maximum voltage and current on Pins 1, 7, 8, and 9 is 55VDC; 10.0 mA.

Remote Shutdown Via the DB-9 Connector

The PowerSure PSP can be shut down remotely by shorting Pins 5 and 6 or via Pins 4 and 5 of the DB-9 connector.

Shutdown Via Pins 5 & 6

When Pin 6 is shorted to Pin 5, the UPS output is shut off regardless of what mode the UPS is operating in. The UPS cannot be started as long as the pins are shorted. When the short is removed, the UPS output can be enabled by pressing the ON/OFF/Alarm Silence button.

Shutdown Via Pins 4 & 5

While the UPS is operating on battery (with no battery test in progress), a 5-12VDC signal for 2 seconds or longer is required to signal a shutdown. Signals for less than 2 seconds are ignored.

After Pin 4 receives the shutdown signal, a 2-minute shutdown timer inside the UPS begins a countdown. The timer cannot be stopped. If utility power returns during the 2-minute timer countdown, the shutdown timer continues until the end of 2 minutes and then the UPS turns off. The UPS must remain off for at least 10 seconds.

By default, autorestart is enabled so the UPS will restart after 10 seconds. If autorestart is disabled via MultiLink software, the UPS remains off until a manual restart.

USB Interface Port

The PowerSure PSP has a USB interface port for communication that will work with built-in Microsoft Power Manager software on the user's PC, if so equipped. It will provide UPS status and manages the automatic, orderly shutdown of the computer. The UPS (USB) communications meets HID standard, version 1.11. All USB models are compatible with Microsoft Windows 2000, Windows XP and Mac OS 10.2 or later. All USB models ship with a 6-ft. (1.8m) USB cable.



Microsoft, Windows, and the Windows logo are trademarks, or registered trademarks of Microsoft Corporation in the United States and/or other countries.

Data Line Protection Connectors

Data line (1 input & 1 output) connectors are located on the rear of the UPS and provide transient voltage surge suppression (TVSS) for Phone/Fax/DSL/Internet/Modem devices.

MAINTENANCE

The PowerSure PSP UPS requires very little maintenance. Follow these practices to prevent problems.

Cleaning the UPS

The following will help ensure trouble-free operation for years:

- Vacuum dust from the ventilation intake occasionally.
- Wipe the cover periodically with a dry cloth.

Maintaining Batteries

The batteries are valve-regulated, nonspillable, lead acid and must be kept charged to retain their design life. The UPS continuously charges the batteries when connected to the utility supply, even while the UPS is switched off.

When storing the UPS, it is recommended to plug in the UPS for at least 24 hours every four to six months to ensure full recharge of the batteries.

Battery Replacement



CAUTION

A battery can present a risk of electrical shock and high short circuit current. The following precautions should be observed before replacing the batteries:

- Remove rings, watches, and other metal objects.
- Do not lay tools or other metal objects on top of the batteries.
- If the battery replacement kit is damaged in any way or shows signs of leakage, contact your local dealer or Liebert representative immediately.
- Do not dispose of batteries in a fire. The batteries may explode.
- Dispose of old batteries according to local codes.

This UPS is equipped with internal “hot swappable” batteries that the user can replace without shutting down the UPS or connected loads.



NOTE

Caution should be exercised when replacing the batteries because the load is unprotected from disturbances and power outages during this procedure.

Battery Replacement Procedure

Replacement requires removing the battery cover plate on the bottom of the UPS. No tools are needed.

To replace the batteries:

1. Remove the battery cover plate on the bottom of the UPS.



Bottom view of UPS

2. Pull the white tab towards you to remove the battery from the UPS. Pivot battery 90 degrees clockwise as shown below.

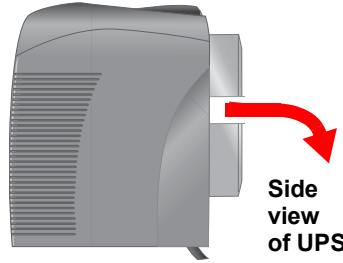

Side view of UPS

3. Disconnect the insulated connectors from the battery terminals.

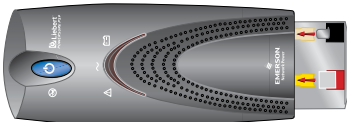

Front view of UPS

4. Insert a new battery pack, and push the connectors onto the battery terminals (black to black & red to red).

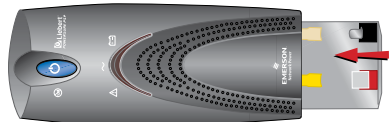

Front view of UPS



NOTE

There may be a small spark at the battery terminals when reconnecting the connectors. This is normal and will not harm you or the UPS.

5. Push the battery pack into the UPS.

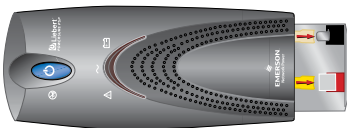

Front view of UPS

6. Reattach the battery cover plate.



Bottom view of UPS

TROUBLESHOOTING

The information below indicates various symptoms a user may encounter in the event the PowerSure PSP experiences a problem. Use this information to determine whether external factors caused the problem. See **Troubleshooting Chart** for suggested remedy.

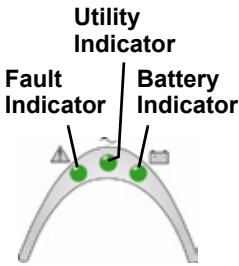

1. The Fault indicator illuminates, indicating the UPS detected a problem.
2. An alarm sounds, alerting that the UPS requires attention. The alarm can be silenced except for low battery, overload and over-temperature warning conditions.
3. Utility and/or Battery indicators may be illuminated as a diagnostic aid to the operator, as shown below:

Guide to Status Indicators

Fault Indicator	Utility Indicator	Battery Indicator	Diagnosis/ Audible Alarm
—		—	Normal operation with utility power present; no beep.
—	—		UPS is operating on battery; beep every 10 seconds.
—	—		Battery test has been initiated; no beep.
—			Battery needs to be replaced; long beep every minute.
—	—		Low battery warning; beep every half-second.
		—	Overload warning, load is >100%; beep every half-second.
	—	—	Overload shutdown, load exceeds UPS capacity (110%); continuous beep.
		—	Over temperature (overtmp) warning; beep every 5 seconds (Normal mode).
	—		Over temperature (overtmp) warning; beep every 5 seconds (Battery mode).
	—	—	Over temperature (overtmp) shutdown; long beep every 5 seconds.
		—	UPS is on, fault warning; continuous beep.
	—	—	UPS has failed & shut down; continuous beep.

Troubleshooting Chart

If the UPS fails to operate properly, turn off the unit and repeat the steps in the **Installation** section of this manual. If the problem persists, refer to the chart below:

Problem	Cause	Solution
UPS will not start	Overload/Short Circuit	Check the circuit protector on the rear of the UPS. If it is tripped, reset it and restart the UPS. For further help, call your local dealer, Liebert representative or the Liebert Worldwide Support Group.
	Battery disconnected or is completely discharged	Check for proper connection of battery or batteries.
UPS starts on battery, but will not switch to AC	UPS not plugged in	Plug in the power cord securely.
	Circuit protector tripped	Reset the circuit protector and restart the UPS.
	Power not available at utility receptacle	Have the utility checked by a qualified electrician.
	Input voltage below threshold	Wait until the voltage rises to an appropriate level or have the utility checked by a qualified electrician.
	AC overvoltage	Wait until voltage lowers to an appropriate level or have the utility checked by a qualified electrician.
UPS shuts down, Fault Indicator lit	Overload/Short Circuit	Check the circuit protector on the rear of the UPS. If it is tripped, reset it and restart the UPS.
	Internal UPS fault	If the problem persists, disconnect some of the equipment from your UPS—the total wattage of your equipment must not exceed the capacity of the UPS. For further help, call your local dealer, Liebert representative or the Liebert Worldwide Support Group.
	High temp shutdown	Make sure that the UPS is operating in 32°F to 104°F (0°C to 40°C) and that it has adequate ventilation.
	MultiLink shutdown	Consult the MultiLink user manual or contact your LAN administrator.
Site Wiring Fault Indicator illuminated	Line-neutral reversal, Poor ground connection	Have the utility checked by a qualified electrician.
UPS not providing expected back-up time	Overload	Reduce load.
	Battery not charged due to a recent outage	Recharge battery.
	Battery needs to be replaced	Replace battery.

SPECIFICATIONS

Model Number	PSP350MT-120	PSP500MT-120	PSP650MT-120
Power Rating VA/W	350VA/210W	500VA/300W	650VA/390W
DIMENSIONS: in. (mm)			
Unit W x D x H	3.7 x 9.5 x 8 (95 x 240 x 205)	3.7 x 9.5 x 8 (95 x 240 x 205)	3.7 x 9.5 x 8 (95 x 240 x 205)
Shipping W x D x H	6.7 x 13.1 x 11.5 (171 x 332 x 293)	6.7 x 13.1 x 11.5 (171 x 332 x 293)	6.7 x 13.1 x 11.5 (171 x 332 x 293)
WEIGHT: lbs (kg)			
Unit	10.2 (4.6)	10.2 (4.6)	10.2 (4.6)
Shipping	12.6 (5.7)	12.6 (5.7)	12.6 (5.7)
INPUT AC PARAMETERS			
Surge Protection	570J		
Rated Input Voltage	120VAC		
Voltage Range Without Battery Operation	90VAC - 145VAC, DIP switch selectable (see DIP switch settings on page 13)		
Frequency Range	46.5 - 63.5 Hz (± 0.1 Hz)		
Input Power Cord	6 ft. (1.8m) attached, w/ NEMA 5-15 P		
OUTPUT AC PARAMETERS			
Output Receptacles	(4) NEMA 5-15R (orange) Battery backup + surge protection; (2) NEMA 5-15R (black) Surge protection		
Voltage (Battery mode)	120VAC $\pm 8\%$		
Output Current	2.9 A	4.2 A	5.4 A
Waveform (Battery mode)	Stepped Sinewave		
Frequency	50 Hz or 60 Hz; auto sensing		
Overload Warning (Normal & Battery modes)	>100%		
Overload Shutdown	>110%		
BATTERY PARAMETERS			
Type	Valve-regulated, nonspillable, lead acid		
Quantity x Voltage x Rating	(1) x 12V x 7Ah	(1) x 12V x 7Ah	(1) x 12V x 9Ah
Transfer Time	4 - 6 ms typical		
Backup Time:	At 77°F (25°C), resistive loading, with fully charged batteries		
Full Load	9 minutes	4 minutes	5 minutes
Half Load	24 minutes	17 minutes	14 minutes
Recharge Time	6 hours to 90% of rated capacity, after full discharge into resistive load		
ENVIRONMENTAL			
Operating Temperature	+32°F to +104°F (0°C to +40°C)		
Storage Temperature	+5°F to +104°F (-15°C to +40°C)		
Relative Humidity	0% to 95%, non-condensing		
Operating Elevation	Up to 10,000 ft. (3000m) at 86°F (30°C) without derating		
Audible Noise	< 40 dBA, at 1 meter		

AGENCY	
Safety	UL 1778, c-UL Listed
Surge	ANSI C62.41, Category A, Level 3 (IEEE 587, Category A); EN61000-4-5, Level 3, Criteria A
ESD	EN61000-4-2, Level 3, Criteria A
Susceptibility	EN61000-4-3, Level 3, Criteria A
Electrical Fast Transient/Burst	EN61000-4-4, Level 4, Criteria A
Emissions	FCC Part 15, Subpart B, Class B
Conducted Immunity	EN61000-4-6, Level 3, Criteria A
Harmonics	EN61000-3-2
Flicker	EN61000-3-3
Transportation	ISTA Procedure 1A

Battery Run Times

Load %	350VA	500VA	650VA
5	319	156	192
10	146	113	95
20	75	49	42
30	45	31	30
40	35	22	21
50	24	17	14
60	20	11	13
70	17	9	10
80	13	7	7
90	10	5	6
100	9	4	5



NOTE

Approximate discharge times are in minutes and at 77°F (25°C) with a resistive load.

Product Warranty Registration

To register for warranty protection:

- Visit the **Quick Links** section of our Web site at:
<http://www.liebert.com>
- Click on **Product Warranty Registration** and fill in the form.

If you have any questions, please contact us at:

US: 800-222-5877

Outside the US: 614-841-6755

upstech@liebert.com

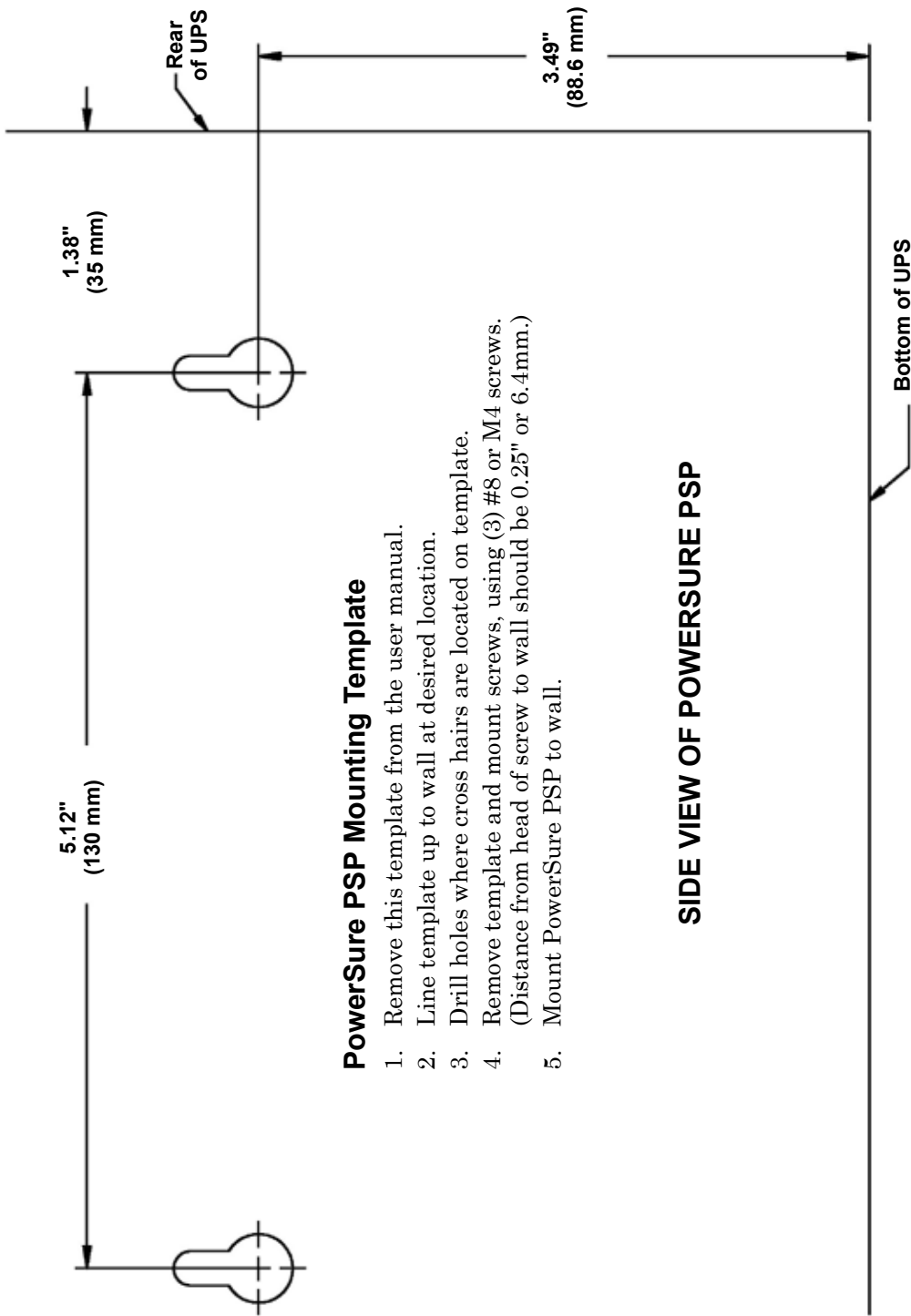

PowerSure PSP Mounting Template

1. Remove this template from the user manual.
2. Line template up to wall at desired location.
3. Drill holes where cross hairs are located on template.
4. Remove template and mount screws, using (3) #8 or M4 screws. (Distance from head of screw to wall should be 0.25" or 6.4mm.)
5. Mount PowerSure PSP to wall.

SIDE VIEW OF POWERSURE PSP

**DISCONTINUED
PRODUCT**

**DISCONTINUED
PRODUCT**

POWER AVAILABILITY

POWERSURE™ PSP

USER MANUAL

The Company Behind the Products

With over a million installations around the globe, Liebert is the world leader in computer protection systems. Since its founding in 1965, Liebert has developed a complete range of support and protection systems for sensitive electronics:

- Environmental systems—close-control air conditioning from 1 to 60 tons
- Power conditioning and UPS with power ranges from 300VA to more than 1000kVA
- Integrated systems that provide both environmental and power protection in a single, flexible package
- Monitoring and control—from systems of any size or location, on-site or remote
- Service and support through more than 100 service centers around the world and a 24/7 Customer Response Center

While every precaution has been taken to ensure the accuracy and completeness of this literature, Liebert Corporation assumes no responsibility and disclaims all liability for damages resulting from use of this information or for any errors or omissions.

© 2005 Liebert Corporation

All rights reserved throughout the world. Specifications subject to change without notice.

© Liebert and the Liebert logo are registered trademarks of Liebert Corporation. All names referred to are trademarks or registered trademarks of their respective owners.

SL-23280 (4/05) Rev. 3

Technical Support/Service

Web Site
www.liebert.com

Monitoring
800-222-5877
monitoring@liebert.com
Outside the US: 614-841-6755

Single-Phase UPS
800-222-5877
upstech@liebert.com
Outside the US: 614-841-6755

Three-Phase UPS
800-543-2378
powertech@liebert.com

Environmental Systems
800-543-2778

Outside the United States
614-888-0246

Locations

United States
1050 Dearborn Drive
P.O. Box 29186
Columbus, OH 43229

Italy
Via Leonardo Da Vinci 8
Zona Industriale Tognana
35028 Piove Di Sacco (PD)
+39 049 9719 111
Fax: +39 049 5841 257

Asia
23F, Allied Kajima Bldg.
138 Gloucester Road
Wanchai
Hong Kong
+852 2 572 2201
Fax: +852 2 831 0114



EMERSON[™]
Network Power

DISCONTINUED
PRODUCT