



POWER PROTECTION

Series 300™ UPS

Three Phase

10 kVA to 125 kVA; 60 Hz

Installation, Operation,
& Maintenance Manual

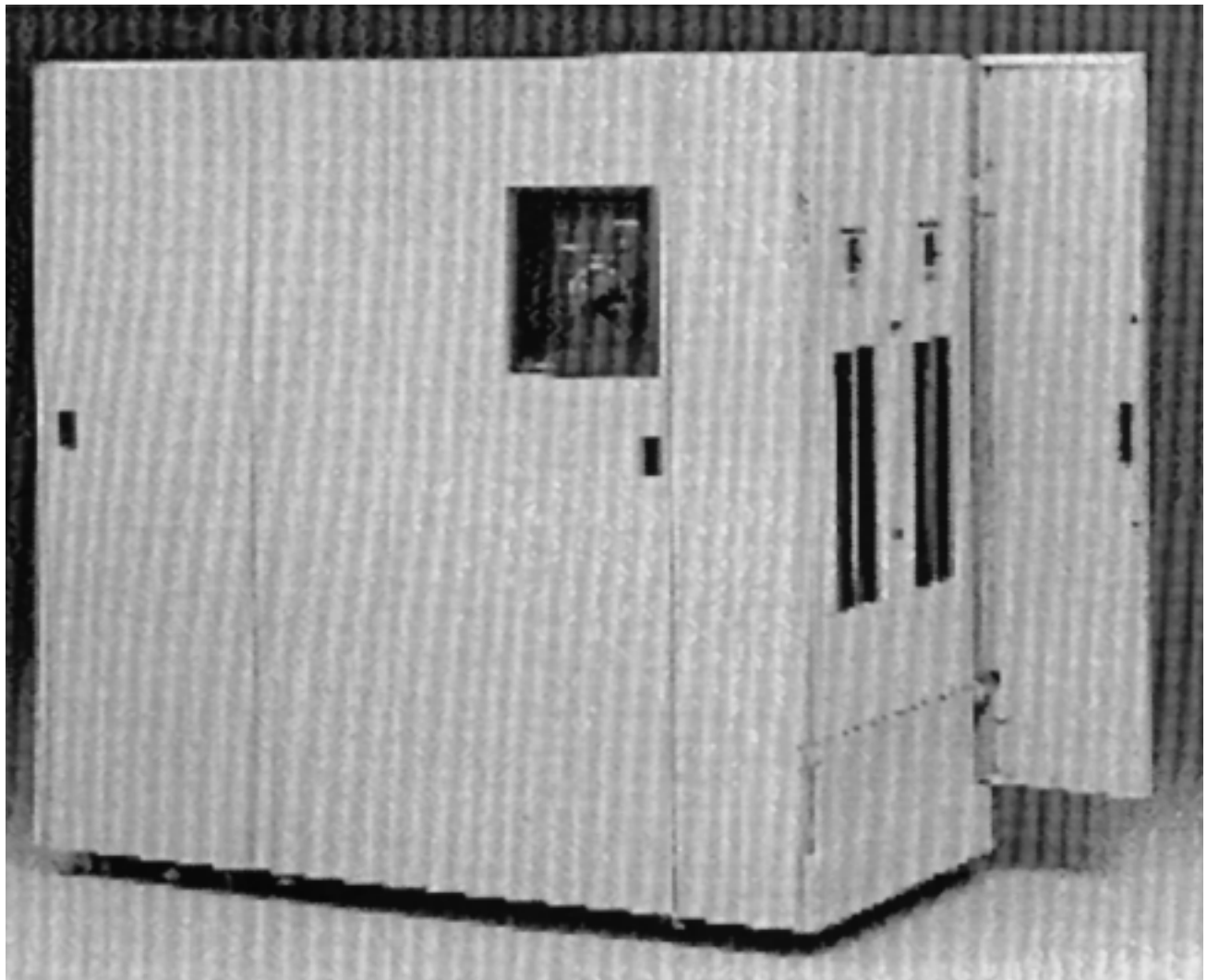

TABLE OF CONTENTS

IMPORTANT SAFETY INSTRUCTIONS	1
1.0 INTRODUCTION	
1.1 Definitions	4
1.2 Modes of Operation	6
1.2.1 Through the UPS Module	6
1.2.2 Static Bypass Line	6
1.2.3 Maintenance Bypass Line	6
2.0 INSTALLATION	
2.1 Safety Precautions	7
2.2 UPS Installation	10
2.2.1 Installation Considerations	10
2.2.2 Unloading and External Inspection	11
2.2.3 Internal Inspection of the UPS System	11
2.2.4 Equipment Location	11
2.3 Battery Installation	12
2.3.1 Matching Battery Cabinets	13
2.3.2 Non-Standard Batteries	14
2.4 Electrical Wiring	15
2.4.1 UPS Wire Size Guidelines	15
2.4.2 Power and Control Wiring	15
2.4.3 Battery Wiring	16
2.4.4 Wiring Connections	19
2.4.5 Wiring Inspection	19
3.0 OPERATION	
3.1 Operator Controls and Indicators	33
3.1.1 Digital Display Screen	33
3.1.2 Selection Pads	35
3.1.3 Power Status Diagram	35
3.1.4 Rotary Switch	36
3.1.5 Advisory Display	36
3.2 Display Screen Menu	37
3.3 Default Screen Messages	38
3.3.1 Normal Operation	38
3.3.2 Warning: Load on Maintenance Bypass	38
3.3.3 Warning: Load on UPS	39
3.3.4 Warning: Load on Static Bypass	39
3.3.5 Fault: System Shutdown	39
3.3.6 UPS on Battery	39

3.4	Alarm Messages	40
3.4.1	UPS Response to an Alarm	40
3.4.2	Operator Response to an Alarm.	40
3.5	System Status Screens	41
3.5.1	Meter Functions	41
3.5.2	System Configuration.	42
3.5.3	Alarm History	46
3.5.4	Lamp Test	46
3.6	Start-Up	47
3.6.1	Start-Up Procedure	47
3.6.2	Abnormal Conditions During Start-Up.	51
3.6.3	Response to an Incorrect Start-Up Sequence	52
3.7	Normal Operation.	53
3.8	Shutdown	54
3.8.1	Shutdown to Maintenance Bypass	54
3.8.2	Complete Shutdown	54
3.8.3	Emergency Shutdown.	54
3.9	Response to a Power Failure	55
3.9.1	UPS Response.	55
3.9.2	Operator Response	56
3.9.3	As Battery Time Approaches Zero.	56
3.10	Response to a UPS Failure	57
3.10.1	UPS Response.	57
3.10.2	Operator Response	57
3.11	Alarm Messages	58
4.0	MAINTENANCE	
4.1	Safety Precautions	61
4.2	When To Call	62
4.3	Steps To Take	62
4.4	Preventive Maintenance	63
4.4.1	Maintaining an Operator's Log	63
4.4.2	Changing the Air Filter	63
4.4.3	Periodic Restart of the UPS.	63
4.4.4	Maintaining the Battery	64
4.5	Liebert Customer Service and Support.	69
5.0	SYSTEM OPTIONS	
5.1	General	70
5.2	Optional External Maintenance Bypass Cabinet.	71
5.2.1	Installation	71
5.2.2	Operation	73

5.3	Optional Slim-Line Distribution	76
5.4	Optional Remote Status Panel.	76
5.5	Optional Remote Contact Board	76
5.6	Optional RS-232 Interface Port	77
5.6.1	Using a Terminal as a Remote Station.	77
5.6.2	Remote Front Panel (Terminal Mode)	78
5.6.3	Emerson Standard Protocol (ESP)	79
5.6.4	Remote Load Control	79
5.6.5	Setting the Password	79
5.7	Optional Internal SNMP (Simple Network Management Protocol) Support	80
5.7.1	Using an SNMP Adapter (Optional)	80
5.8	Optional Internal Modem.	81
5.8.1	The Communication Mode Screen.	81
5.8.2	Using the Modem	82
5.8.3	Setting the Data Rate	86
5.9	Optional SiteScan [®] /Sitemaster Interface	87
5.10	Optional IBM [®] AS/400 Signal Interface	87
5.11	Optional System/38 Power Warning Signal	88
5.12	Optional Battery Circuit Breaker	88
5.13	Optional Contact Isolator Board	88
5.14	Optional DC Ground Fault Alarm.	88
5.15	Optional Computer Interface System	88
5.16	Optional Multi-Computer Interface System	89
5.17	Optional IBM [®] AS/400 Multi-Interface System	89
6.0	SPECIFICATIONS	
6.1	Electrical Specifications	103
6.1.1	AC Inputs to UPS.	103
6.1.2	AC Output. UPS Inverter	104
6.2	Ratings	105
6.3	Environmental Specifications	105
6.4	Mechanical Specifications	105
6.5	Battery	106

FIGURES

Figure 1	Single Line Diagram 10-125 kVA	20
Figure 2	Single Line Diagram 10-125 kVA with Optional External Maintenance Bypass	21
Figure 3	UPS Cabinet Installation Diagram 10-30 kVA	22
Figure 4	UPS Cabinet Installation Diagram 40-50 kVA	23
Figure 5	UPS Cabinet Installation Diagram 65-125 kVA	24
Figure 6	Battery Cabinet Installation Diagram - 22-inch Frame	25
Figure 7	Battery Cabinet Installation Diagram - 36-inch Frame	26
Figure 8	Control Wiring Diagram 10-30 kVA	28
Figure 9	Control Wiring Diagram 40-50 kVA	29
Figure 10	Control Wiring Diagram 65-125 kVA	30
Figure 11	Field Wiring Terminations	31
Figure 12	Operator Controls and Indicators on UPS Module Cabinet Front	33
Figure 13	Block Diagram of the Series 300 UPS	34
Figure 14	Display Screen and Selection Pads	35
Figure 15	Power Status Diagram	35
Figure 16	Rotary Switch and Advisory Display	36
Figure 17	Menu Selection Arrangement	37
Figure 18	External Maintenance Bypass Rotary Switch	73
Figure 19	Block Diagram of the External Maintenance Bypass	74
Figure 20	Cable Connections between UPS and Terminal	77
Figure 21	UPS Remote Monitor/Control	78
Figure 22	Optional Maintenance Bypass Cabinet	90
Figure 23	Optional Maintenance Bypass Cabinet with Isolation Transformer	91
Figure 24	Optional Slim-Line Distribution	92
Figure 25	Optional Remote Status Panel	94
Figure 26	Optional Remote Contact Board	95
Figure 27	Optional IBM® AS/400 Signal Interface	96
Figure 28	Optional IBM® AS/400 Signal Interface (with Remote Status Panel)	97
Figure 29	Optional Battery Circuit Breaker 10-75 kVA	98
Figure 30	Optional Battery Circuit Breaker 100-125 kVA	99
Figure 31	Optional Computer Interface System	100
Figure 32	Optional Multi-Computer Interface System	101
Figure 33	Optional IBM® AS/400 Multi-Interface System	102

TABLES

Table 1	Model Numbers and Ratings	3
Table 2	Site Planning Data, Series 300 UPS, 10 to 50 kVA	8
Table 3	Site Planning Data, Series 300 UPS, 65 to 125 kVA	9
Table 4	Table 310-16	17
Table 5	Connection Type / Wire Size Range	18
Table 6	Torque Specifications (Unless Otherwise Labeled)	18
Table 7	Alarm Messages During Start-Up	51
Table 8	Alarm Messages	58
Table 9	Terminal Mode Menu	78
Table 10	Dial-Out Events	82
Table 11	Last Attempt(s) Messages	86
Table 12	Matching Battery Cabinets	106

IMPORTANT SAFETY INSTRUCTIONS

Save These Instructions.

This manual contains important instructions that should be followed during installation and maintenance of your Series 300 UPS and batteries.



WARNING

EXERCISE EXTREME CARE WHEN HANDLING UPS AND BATTERY CABINETS TO AVOID EQUIPMENT DAMAGE OR INJURY TO PERSONNEL. CABINET WEIGHTS RANGE FROM 1, 100 POUNDS (500 KG) TO 2,700 POUNDS (1225 KG).

TEST LIFT AND BALANCE THE CABINETS BEFORE TRANSPORTING. MAINTAIN MINIMUM TILT FROM VERTICAL AT ALL TIMES. BOTTOM STRUCTURE WILL SUPPORT THE UNIT ONLY IF THE FORKS ARE COMPLETELY BENEATH THE UNIT.

OBSERVE ALL BATTERY SAFETY PRECAUTIONS IN 4.0 - MAINTENANCE WHEN SERVICING BATTERIES. THE HAZARD OF ELECTRIC SHOCK IS PRESENT EVEN WHEN THE UPS IS OFF. MAINTAIN BATTERIES BELOW MAXIMUM RECOMMENDED TEMPERATURE TO AVOID RELEASING SULFURIC ACID VAPORS.

IN CASE OF FIRE INVOLVING ELECTRICAL EQUIPMENT, ONLY CARBON DIOXIDE FIRE EXTINGUISHERS, OR THOSE APPROVED FOR USE IN ELECTRICAL FIRE FIGHTING, SHOULD BE USED.

EXTREME CAUTION IS REQUIRED WHEN PERFORMING MAINTENANCE. LETHAL VOLTAGES EXIST WITHIN THE EQUIPMENT DURING OPERATION. OBSERVE ALL WARNINGS AND CAUTIONS IN THIS MANUAL. FAILURE TO COMPLY MAY RESULT IN SERIOUS INJURY OR DEATH. OBTAIN QUALIFIED SERVICE FOR THIS EQUIPMENT AS INSTRUCTED.

WHEN THE ROTARY SWITCH IS IN POSITION 1, UPS COMPONENTS ARE DE-ENERGIZED WITH THE EXCEPTION OF EMI CAPACITORS, ROTARY SWITCH, INPUT/OUTPUT TERMINALS BATTERY CABINET, AND THE INPUT TRANSFORMER. ALL INPUT POWER MUST BE REMOVED TO ACHIEVE COMPLETE ISOLATION.

BE CONSTANTLY AWARE THAT THE UPS SYSTEM CONTAINS HIGH DC AS WELL AS AC VOLTAGES. WITH INPUT POWER OFF AND THE BATTERY DISCONNECTED, HIGH VOLTAGE AT FILTER CAPACITORS AND POWER CIRCUITS SHOULD BE DISCHARGED WITHIN 30 SECONDS. HOWEVER, IF A POWER CIRCUIT FAILURE HAS OCCURRED, YOU SHOULD ASSUME THAT HIGH VOLTAGE MAY STILL EXIST AFTER SHUTDOWN. CHECK WITH AC AND DC VOLTMETERS BEFORE MAKING CONTACT.

WHEN USING TEST EQUIPMENT WHILE THE UPS SYSTEM IS UNDER POWER, BOTH THE OPERATOR AND ANY TEST EQUIPMENT MUST BE ISOLATED FROM DIRECT CONTACT WITH EARTH GROUND AND THE UPS CHASSIS FRAME BY USING RUBBER MATS.



WARNING

SOME COMPONENTS WITHIN THE CABINETS ARE NOT CONNECTED TO CHASSIS GROUND. ANY CONTACT BETWEEN FLOATING CIRCUITS AND THE CHASSIS IS A LETHAL SHOCK HAZARD.



WARNING

INTERNAL BATTERY STRAPPING MUST BE VERIFIED BY MANUFACTURER PRIOR TO MOVING THIS UNIT.

THIS UNIT CONTAINS NON-SPILLABLE BATTERIES. KEEP UNIT UPRIGHT. DO NOT STACK. DO NOT TIP.

FAILURE TO HEED THIS WARNING COULD RESULT IN SMOKE, FIRE, OR ELECTRIC HAZARD.

CALL 1-800-LIEBERT PRIOR TO MOVING UNIT.

IBM-PC[®], Macintosh[®], Procomm[®], Microsoft Windows[®], CompuServe[®], and NEC[®] are registered trademarks of their respective companies.

Telix[™], IBM[™], AS/400[™], and System/38[™] are trademarks of their respective companies.

1.0 INTRODUCTION

Liebert Series 300 Uninterruptible Power Systems supply critical loads with continuous computer grade power. Reliability and performance are key design considerations. The UPS design also maximizes isolation of the load from disturbances and interruptions, minimizes maintenance and repair time, and provides monitoring of significant system operating characteristics.

Proper installation and operation of the UPS are equally important factors in system reliability. This manual contains complete information on installation, operation, and preventive maintenance of the Uninterruptible Power System (UPS) and Battery Cabinet. Illustrations showing the function of all operator controls, instruments, alarms and indicating lights are also given. Performance specifications at which the UPS will operate are given in **6.0 - Specifications**. Please note that some information is kVA specific.

The Liebert Series 300 UPS is available in ten power ratings: 10, 15, 20, 30, 40, 50, 65, 75, 100, and 125 kVA. Specifications for each model appear in **6.0 - Specifications**. The same principles of operation apply to all models.



CAUTION

This entire manual should be read prior to installation, performing start-up procedures or system operation or maintenance. Improper installation has proved to be the single most significant cause of start-up problems.



WARNING

LETHAL VOLTAGES EXIST WITHIN THIS EQUIPMENT DURING OPERATION. FAILURE TO OBSERVE ALL SAFETY PRECAUTIONS MAY RESULT IN SERIOUS INJURY OR DEATH. OBTAIN QUALIFIED SERVICE PERSONNEL FOR THIS EQUIPMENT AS INSTRUCTED.

Should assistance be required, call Liebert's toll free Customer Service and Support number: **1-800-543-2378**. Please have the following information available for fast assistance:

Model Number: _____
Serial Number: _____
kVA Rating: _____
Date Delivered: _____
Date Installed: _____
Input Voltage: _____
Output Voltage: _____

Table 1 Model Numbers and Ratings

Rating	Model Number									
	311	321	331	341	346	356	361	366	376	381
kVA	10	15	20	30	40	50	65	75	100	125
kW	8	12	16	24	32	40	52	60	80	100

1.1 Definitions

These definitions describe terms as they relate specifically to Series 300 installation, operation or maintenance. Rather than being alphabetized, they are presented in an order most appropriate to understanding the UPS.

Uninterruptible Power System (UPS)

All components within UPS Module Cabinet and separate Battery Cabinet which function as a system to provide continuous, conditioned AC power to a load.

UPS Module

Rectifier/Charger and Inverter unit which, under supervision of the Internal Control System and Operator Controls, provides specified AC power to a critical load.

UPS Module Cabinet

Metal enclosure containing rectifier/charger, inverter, static transfer switch, static bypass line, maintenance bypass line, external operator controls, and internal control system required to provide specified AC power to a load.

Battery Cabinet

Liebert Matching (factory supplied) Battery Cabinet containing sealed battery cells sufficient to maintain UPS output according to specifications in **6.0 - Specifications**.

Input Power

Power provided by the electrical utility company (or auxiliary generator) and connected to the UPS input.

Input Filter

Reduces rectifier input current distortion to 10% THD at full load. This filter also improves the input power factor.

Input Isolation Transformer

A delta-to-wye isolation transformer for the UPS module input. Provides common mode noise attenuation for all system operating modes including while on bypass. Also provides single-point ground for the system.

Input Auto Transformer

A delta-to-wye auto transformer for the UPS module input. Enables UPS module to be installed with external maintenance bypass cabinet without requiring a transformer in the external maintenance bypass line.

Rectifier/Charger

UPS component containing equipment and controls for converting input AC power to regulated DC power required for battery charging and for supplying power to the inverter.

Inverter

UPS component containing equipment and controls for converting DC power from Rectifier/Charger or battery to regulated AC power required by the critical load.

Internal Control System

Signal processing circuits which regulate power conversion processes, detect fault conditions and control the UPS operating sequence.

Operator Controls and Display

Rotary switch, selection pads, and digital display used by operators to monitor and control the UPS. See **3.0 - Operation** of this manual.

Static Bypass Line

Line conducting unconditioned input power to critical load through Static Transfer Switch. Transfer of load between this line and the UPS inverter output occurs under supervision of the Internal Control System.

Static Transfer Switch

Device transferring the critical load between UPS inverter output and Static Bypass Line.

Transfer

The critical load is transferred from the UPS inverter output to the Static Bypass Line.

Retransfer

The critical load is automatically retransferred from the Static Bypass Line back to the UPS inverter output.

Maintenance Bypass Line

Line conducting electricity directly from input power to critical load during maintenance or whenever UPS is not completely operational. Maintenance Bypass Line is connected when rotary switch is in Position 1, 2, or 3.

External Maintenance Bypass Cabinet

An external maintenance bypass line in a matching cabinet with switching mechanism, and optional circuit breakers and optional bypass transformer, to totally isolate the UPS module from the electrical system.

Slim-Line Distribution Cabinet

A cabinet extension of the UPS module to enclose one or two 42-pole panelboards, with a main circuit breaker for each panelboard.

1.2 Modes of Operation

The UPS provides the following three power paths between the utility source and the critical load.

- Through the UPS Module
- Static Bypass Line
- Maintenance Bypass Line.

1.2.1 Through the UPS Module

During normal operation, the output of the **UPS Module** inverter is used. Input AC power to the UPS is converted to DC by the rectifier/charger. The DC power charges the UPS battery and provides input power for the inverter. The inverter converts the DC power to conditioned AC power which supplies the critical load. The conversion-inversion process eliminates voltage transients existing in the input power before it reaches the critical load. If input power is interrupted, the battery will immediately supply the DC power required by the inverter to maintain continuous AC power to the load. A fully charged battery will provide power for the specified time at the rated load, or longer at a reduced load.

1.2.2 Static Bypass Line

The **Static Bypass Line** provides an alternate power path during an overload condition or UPS fault. If the load demands more power than the inverter can supply (an overload condition), the control system automatically energizes the static transfer switch to transfer the load from the UPS Module to the Static Bypass Line. If the internal control system detects a fault in the UPS Module while it is supporting the load, the static transfer switch transfers the load without interruption to the Static Bypass Line, thereby maintaining continuous power to the critical load.

1.2.3 Maintenance Bypass Line

The **Maintenance Bypass Line** is a hard-wired line through the UPS which supplies the critical load with unconditioned power when the Rotary Switch is in Position 1, 2, or 3. The purpose of this line is to route power to the critical load during start-up or while the UPS Module is de-energized for maintenance. The Maintenance Bypass Line can only be selected manually, using the Rotary Switch. When the Rotary Switch is in Position 4, the internal control system determines which of the other two paths supplies power to the load.

2.0 INSTALLATION

2.1 Safety Precautions

Read this manual thoroughly, paying special attention to the sections that apply to you, before working with the UPS. Also read the battery manufacturer's manual before working on or near the battery.

Under typical operation and with all UPS doors closed, only normal safety precautions are necessary. The area around the UPS system and Battery should be kept free from puddles of water, excess moisture, or debris.

Special safety precautions are required for procedures involving handling, installation, and maintenance of the UPS system or the battery. Observe precautions in **2.0 - Installation** before handling or installing the UPS system. Observe precautions in **4.0 - Maintenance**, before as well as during performance of all maintenance procedures. Observe all battery safety precautions before working on or near the battery.

This equipment contains several circuits that are energized with high voltage. Only test equipment designated for troubleshooting should be used. This is particularly true for oscilloscopes. Always check with an AC and DC voltmeter to ensure safety before making contact or using tools. Even when the power is turned Off, dangerously high potentials may exist at the capacitor banks. Observe all battery precautions when near the battery for any reason.

ONLY qualified service personnel should perform maintenance on the UPS system. When performing maintenance with any part of the equipment under power, service personnel and test equipment should be standing on rubber mats. The service personnel should wear insulating shoes for isolation from direct contact with the floor (earth ground).

Unless power is removed from the equipment, one person should never work alone. A second person should be standing by to assist and summon help in case an accident should occur. This is particularly true when work is performed on the battery.

A **Warning** signals the presence of a possible serious, life-threatening condition. For example:



WARNING

LETHAL VOLTAGES MAY BE PRESENT WITHIN THIS UNIT EVEN WHEN IT IS APPARENTLY NOT OPERATING. OBSERVE ALL CAUTIONS AND WARNINGS IN THIS MANUAL. FAILURE TO DO SO COULD RESULT IN SERIOUS INJURY OR DEATH. DO NOT WORK ON OR OPERATE THIS EQUIPMENT UNLESS YOU ARE FULLY QUALIFIED TO DO SO!! NEVER WORK ALONE.

A **Caution** indicates a condition that could seriously damage equipment and possibly injure personnel. For example:



CAUTION

Start-up must be performed exactly as instructed. Follow prompts on the Advisory Display. Turning the Rotary Switch too soon may result in immediate loss of power to the critical load.

A **Note** emphasizes important text. If the note is not followed, equipment could be damaged or may not operate properly. For example:



NOTE

Determine time required to perform an orderly shutdown of the critical load. Begin shutdown so it will be completed while the battery is still supporting the load.

Table 2 Site Planning Data, Series 300 UPS, 10 to 50 kVA

Model	Power Rating		Voltage	Rectifier AC Input						Rectifier AC Input with Optional Input Filter			Battery			AC Output		Mechanical Data				
				Current		Rec **	Current		Rec **	Nominal Voltage	Full Load	Max. Discharge Current	Current	Rec **	Dimensions	Weight	DFL Lb./Ft. ²	Heat Dissipation BTU/hr.	Cooling Air CFM			
				kVA	kW	VAC/Freq	Nom	Max		Nom	Max			kW		Nom		(WxDxH)				
311 *	10	8	208/60Hz 240/60Hz 480/60Hz 600/60Hz	35A 29A 15A 12A	44A 36A 19A 15A	60A 50A 25A 20A	30A 26A 13A 11A	37A 32A 16A 14A	50A 40A 20A	204VDC (102 cells)	9.3	58A	28A 24A 12A 10A	35A 30A 15A 15A	36x28x72 in 91x72x183 cm	1100 lbs 499 kg	157	6000	600			
321 *	15	12	208/60Hz 240/60Hz 480/60Hz 600/60Hz	50A 43A 22A 18A	63A 54A 28A 23A	80A 70A 40A 30A	44A 38A 19A 15A	55A 48A 24A 19A	70A 60A 30A	204VDC (102 cells)	13.8	85A	42A 36A 18A 14A	60A 45A 25A 20A	36x28x72 in 91x72x183 cm	1100 lbs 499 kg	157	6000	600			
331 *	20	16	208/60Hz 240/60Hz 480/60Hz 600/60Hz	65A 56A 28A 23A	81A 70A 35A 29A	100A 90A 50A 40A	57A 50A 25A 20A	72A 62A 31A 25A	90A 80A 40A 30A	360VDC (180 cells)	17.8	62A	56A 48A 24A 20A	70A 60A 30A 25A	36x28x72 in 91x72x183 cm	1400 lbs 635 kg	200	8900	800			
341 *	30	24	208/60Hz 240/60Hz 480/60Hz 600/60Hz	96A 83A 42A 33A	120A 104A 53A 41A	150A 125A 70A 50A	85A 74A 37A 29A	108A 92A 46A 37A	150A 110A 60A 50A	360VDC (180 cells)	26.4	92A	83A 72A 36A 29A	125A 90A 50A 40A	36x28x72 in 91x72x183 cm	1400 lbs 635 kg	200	12300	1050			
346 *	40	32	208/60Hz 240/60Hz 480/60Hz 600/60Hz	128A 111A 55A 44A	160A 139A 69A 55A	200A 175A 90A 70A	113A 98A 49A 39A	142A 123A 61A 49A	175A 150A 80A 60A	360VDC (180 cells)	35.2	122A	111A 96A 48A 39A	150A 125A 60A 50A	36x28x72 in 91x72x183 cm	1900 lbs 882 kg	271	16400	1050			
356 *	50	40	208/60Hz 240/60Hz 480/60Hz 600/60Hz	158A 137A 68A 55A	198A 171A 85A 69A	250A 225A 110A 90A	140A 122A 61A 49A	175A 152A 76A 61A	225A 200A 100A 80A	360VDC (180 cells)	43.7	150A	139A 120A 60A 48A	175A 150A 80A 60A	36x28x72 in 91x72x183 cm	1900 lbs 882 kg	271	18700	1050			
Applicable Notes:			—	1	2	3, 4, 9, 10, 11, 13, 14	1	2	3, 4, 9, 10, 11, 13, 14	5	—	4, 6, 9, 11, 13, 14	1	4, 7, 9, 11, 13, 14	12, 13, 15	15	15	—	—			

For explanation of **Applicable Notes**, see referenced numbers in **Notes** below.

*Field-upgradeable to next larger model

**Rec = Recommended External Overcurrent Protection

Notes

- Nominal (NOM) current is based on full rated output load.
- Maximum (MAX) current (125% of NOM) is short duration for battery recharge conditions.
- UPS input and bypass cables must be run in separate conduit from output cables.
- If the UPS module is to be upgraded in the future, it is recommended that the AC input, bypass AC input, battery, and AC output wiring and overcurrent protection be sized initially for the future upgraded size.
- Nominal battery voltage is shown at 2.0 volts/cell per NEC 480-2.
- Power cables from UPS DC link to batteries should be sized for a total maximum 2.0 volt line drop (measured at UPS) at maximum discharge current.
- Recommended bypass AC input and AC output overcurrent protection represents 125% of nominal full load current (continuous) per NEC 220-2(a).
- UPS output load cables must be run in separate conduit from input and bypass cables.
- Minimum sized grounding conductors to be per NEC 250-95. Parity sized ground conductors are recommended. Neutral conductors to be sized for full capacity per NEC-16 Note 10.
- Wiring requirements:
AC INPUT: 3-phase, 3-wire plus ground (unit supplied with input isolation transformer).
3-phase, 4-wire plus ground (unit supplied with input auto transformer).
AC OUTPUT: 3-phase, 4-wire plus ground.
DC INPUT: 2-wire (positive and negative), plus ground.
- All wiring is to be in accordance with national and local electrical codes.
- Minimum access clearance is 3 feet front and 1 foot above UPS.
- Top or bottom cable entry through removable access plates. Cut plate to suit conduit size, then replace.
- Control wiring and power wiring must be run in separate conduit.
- Battery cabinet not included.

Additional Notes

- If site configuration includes a back-up emergency generator, it is recommended that the engine generator set be properly sized and equipped for a UPS application. Generator options would typically include an isochronous governor (generator frequency regulation) and a UPS compatible regulator (generator voltage regulation). Consult generator manufacturer for required generator options and sizing.
- If site configuration includes an automatic transfer switch, refer to the Liebert Power Line titled "Criteria for Application of Automatic Transfer Switches (ATS) with Uninterruptible Power Supply (UPS) Systems." 91K-PLT-48-02. It is also recommended that the transfer switch be equipped with auxiliary contacts for UPS "on generator" current limit. Consult transfer switch manufacturer for required transfer switch options and sizing.
- If site configuration requires an external isolated maintenance bypass circuit, it should be noted that the Utility AC input is not in phase with the UPS AC output, with the optional delta-wye input isolation transformer. Consult with sales representative or UPS applications engineer.

Table 3 Site Planning Data, Series 300 UPS, 65 to 125 kVA

Model	Power Rating		Voltage	Rectifier AC Input			Rectifier AC Input with Optional Input Filter			Battery			AC Output		Mechanical Data				
				Current		Rec **	Current		Rec **	Nominal Voltage	Full Load	Max. Discharge Current	Current	Rec **	Dimensions (WxDxH)	Weight	DFL Lb./ Ft. ²	Heat Dis-sipation BTU/ hr.	Cooling Air CFM
				Nom	Max	Nom	Max				Nom								
	kVA	kW	VAC/Freq																
361 *	65	52	208/60Hz 240/60Hz 480/60Hz 600/60Hz	197A 171A 85A 68A	246A 214A 106A 85A	300A 300A 150A 110A	182A 158A 79A 63A	228A 197A 99A 79A	300A 250A 125A 100A	360VDC (180 cells)	57.1	198A	180A 155A 78A 63A	225A 200A 100A 80A	54x28x72 in 137x72x183 cm	2500 lbs 1134 kg	238	24200	1200
366	75	60	208/60Hz 240/60Hz 480/60Hz 600/60Hz	234A 203A 101A 81A	293A 254A 126A 101A	400A 350A 175A 125A	208A 180A 90A 72A	260A 225A 113A 90A	350A 300A 150A 125A	360VDC (180 cells)	65.2	225A	208A 180A 90A 72A	300A 225A 125A 90A	54x28x72 in 137x72x183 cm	2500 lbs 1134 kg	238	25400	1200
376 *	100	80	208/60Hz 240/60Hz 480/60Hz 600/60Hz	312A 270A 135A 108A	390A 338A 169A 135A	500A 450A 225A 175A	277A 240A 120A 95A	347A 300A 150A 120A	450A 400A 200A 150A	360VDC (180 cells)	88.5	307A	278A 241A 120A 98A	350A 300A 150A 125A	54x28x72 in 137x72x183 cm	2700 lbs 1225 kg	257	33800	1600
381	125	100	208/60Hz 240/60Hz 480/60Hz 600/60Hz	386A 334A 167A 134A	483A 418A 209A 168A	600A 600A 300A 225A	343A 297A 148A 119A	429A 371A 185A 149A	600A 450A 225A 175A	360VDC (180 cells)	108.1	383A	347A 301A 150A 120A	450A 400A 200A 150A	54x28x72 in 137x72x183 cm	2700 lbs 1225 kg	257	38000	1600
Applicable Notes:	—		—	1	2	3,4 9,10 11 13 14	1	2	3,4 9,10 11 13 14	5	—	4,6 9,10 11 13 14	1	3,4,7 8,9,10 11 13 14	12,13,15	15	15	—	—

For explanation of **Applicable Notes**, see referenced numbers in **Notes** below.

*Field-upgradeable to next larger model

**Rec = Recommended External Overcurrent Protection

Notes

- Nominal (NOM) current is based on full rated output load.
- Maximum (MAX) current (125% of NOM) is short duration for battery recharge conditions.
- UPS input and bypass cables must be run in separate conduit from output cables.
- If the UPS module is to be upgraded in the future, it is recommended that the AC input, bypass AC input, battery, and AC output wiring and overcurrent protection be sized initially for the future upgraded size.
- Nominal battery voltage is shown at 2.0 volts/cell per NEC 480-2.
- Power cables from UPS DC link to batteries should be sized for a total maximum 2.0 volt line drop (measured at UPS) at maximum discharge current.
- Recommended bypass AC input and AC output overcurrent protection represents 125% of nominal full load current (continuous) per NEC 220-2(a).
- UPS output load cables must be run in separate conduit from input and bypass cables.
- Minimum sized grounding conductors to be per NEC 250-95. Parity sized ground conductors are recommended. Neutral conductors to be sized for full capacity per NEC-16 Note 10.
- Wiring requirements:
AC INPUT: 3-phase, 3-wire plus ground (unit supplied with input isolation transformer).
3-phase, 4-wire plus ground (unit supplied with input auto transformer).
AC OUTPUT: 3-phase, 4-wire plus ground.
DC INPUT: 2-wire (positive and negative), plus ground.
- All wiring is to be in accordance with national and local electrical codes.
- Minimum access clearance is 3 feet front and 1 foot above UPS.
- Top or bottom cable entry through removable access plates. Cut plate to suit conduit size, then replace.
- Control wiring and power wiring must be run in separate conduit.
- Battery cabinet not included.

Additional Notes

- If site configuration includes a back-up emergency generator, it is recommended that the engine generator set be properly sized and equipped for a UPS application. Generator options would typically include an isochronous governor (generator frequency regulation) and a UPS compatible regulator (generator voltage regulation). Consult generator manufacturer for required generator options and sizing.
- If site configuration includes an automatic transfer switch, refer to the Liebert Power Line titled "Criteria for Application of Automatic Transfer Switches (ATS) with Uninterruptible Power Supply (UPS) Systems." 91K-PLT-48-02. It is also recommended that the transfer switch be equipped with auxiliary contacts for UPS "on generator" current limit. Consult transfer switch manufacturer for required transfer switch options and sizing.
- If site configuration requires an external isolated maintenance bypass circuit, it should be noted that the Utility AC input is not in phase with the UPS AC output, with the optional delta-wye input isolation transformer. Consult with sales representative or UPS applications engineer.

2.2 UPS Installation

Proper planning will speed UPS unloading, location, and connection. Make sure there is adequate clearance for the UPS module and battery cabinet doors to open full swing. Check for a minimum of 12 in. clearance above both cabinets for exhaust air to flow without restriction. Also allow adequate clearance at bottom front of each cabinet for unrestricted intake air to flow. Make sure room has adequate ventilation and cooling and install UPS in a clean/dry location.

Install UPS according to drawings (**Figure 1 through Figure 11**), **Table 5 and Table 6**, and the following procedures. After installation is complete, contact Liebert Customer Service and Support at **1-800-543-2378** to schedule check-out and start-up assistance.

A Liebert authorized representative must perform an initial system start-up to ensure proper UPS operation. Equipment warranties will be voided unless system start-up is performed by a Liebert authorized representative.



CAUTION

Read this manual thoroughly before attempting to wire or operate the unit. Improper installation is the most significant cause of UPS start-up problems.

Do not install the equipment near any gas or electric heaters. Install the equipment in a restricted location to prevent access by unauthorized personnel.

This equipment generates, uses, and can radiate radio frequency energy and, if not installed and used in accordance with this manual, may cause interference to radio communications. It has been tested and found to comply with the limits for a Class A computing device pursuant to Part 15 of FCC rules, which are designed to provide reasonable protection against such interference when operated in a commercial environment. Operation of this equipment in a residential area is likely to cause interference, in which case the user at his own expense will be required to take whatever measures may be required to correct the interference.

2.2.1 Installation Considerations

1. Utilize the shortest output distribution cable runs possible at the installation site, consistent with logical equipment arrangement and in compliance with NEC and local electrical codes. Allow space for future equipment additions.
2. Recommended ambient temperature for operation is 20 to 30° Celsius (68 to 86°F). Relative humidity must be less than 95% non-condensing. In altitudes above 2000 meters (6,560 feet), the UPS rating will be reduced.
3. The route and foundation to the installation site must be capable of supporting the weight of cabinets and moving equipment. Refer to **Table 2 - Site Planning Data, Series 300 UPS, 10 to 50 kVA** and **Table 3 - Site Planning Data, Series 300 UPS, 65 to 125 kVA** for specific information about cabinet weights.
4. Plan the route to ensure unit will pass through all elevators, corners, and doorways to prevent damage.
5. Heat output of UPS equipment is significant. Be sure environmental conditioning systems can accommodate this heat load, even during utility outages. Refer to **Table 2 - Site Planning Data, Series 300 UPS, 10 to 50 kVA** and **Table 3 - Site Planning Data, Series 300 UPS, 65 to 125 kVA** for more specific information.

2.2.2 Unloading and External Inspection

UPS and battery cabinets are shipped on separate pallets to allow easier handling at the site. Move cabinets as close as possible to the intended location before removing from the pallet.



CAUTION

Do not remove the supporting bands until you intend to remove unit from pallet. Shipping bands are used to secure unit to pallet. Extreme care is necessary during moving. Test lift and balance the cabinets before transporting. Maintain minimum tilt from vertical at all times.

1. Inspect equipment and shipping container(s) for any signs of damage or mishandling. Do not attempt to install the system if damage is apparent. If any damage is noted, file a damage claim with the shipping agency within 24 hours, and contact Liebert Customer Service and Support at **1-800-543-2378** to inform them of the damage claim and the condition of the equipment.
2. Compare contents of shipment with the bill of lading. Report any missing items to the carrier and to Liebert Customer Service and Support immediately.
3. Check nameplate on the inside of cabinet front door to verify model number, kVA rating, and input/output voltage corresponds with the one specified. Record model and serial number in front of this manual. A record of this information is necessary should servicing become required.

2.2.3 Internal Inspection of the UPS System

1. Verify that all items have been received.
2. If spare parts were ordered, verify arrival.
3. Check for shipping damage internally.
4. Check for any loose connections or unsecured components in the UPS module.
5. Check for installation of safety shields on the UPS module. There should not be any exposed terminals when the cabinet doors are opened.
6. Check for any unsafe feature that may be a potential safety hazard.

2.2.4 Equipment Location



WARNING

EACH UPS MODULE AND MATCHING BATTERY CABINET WEIGHS BETWEEN 1100 AND 2700 POUNDS DEPENDING ON MODEL. EXERCISE EXTREME CARE WHEN HANDLING TO AVOID EQUIPMENT DAMAGE OR INJURY TO PERSONNEL. A FORK LIFT OR OTHER ADEQUATE MATERIAL HANDLING DEVICE SHOULD BE USED FOR UNLOADING, MOVING, AND POSITIONING THE CABINETS.

1. Use a fork lift or other material handling device to move the cabinets as close as possible to the final installation site.
2. Casters are provided on the unit to aid in final positioning.
3. As with all electrical equipment, installation and serviceability will be easier if access is provided on all sides of the equipment. Minimum access requirements are 3 feet front, 1 foot top.
4. Verify adequate clearance for cabinet doors to open. See drawings and location codes (4 feet is recommended).
5. Verify adequate clearance above cabinets allowing unrestricted exhaust air to flow (12 inches minimum).
6. Verify UPS system is installed in a clean, cool, and dry location.

2.3 Battery Installation

Battery Safety Precautions

Servicing of batteries should be performed or supervised by personnel knowledgeable of batteries and the required precautions. Keep unauthorized personnel away from batteries. Refer to **4.0 - Maintenance** for additional safety precautions regarding vented batteries.

When replacing batteries, use the same number and type of batteries.



CAUTION

Lead-acid batteries contain hazardous materials. Batteries must be handled, transported, and recycled or discarded in accordance with federal, state, and local regulations. Because lead is a toxic substance, lead-acid batteries should be recycled rather than discarded.

Do not dispose of battery or batteries in a fire. The battery may explode.

Do not open or mutilate the battery or batteries. Released electrolyte is harmful to the skin and eyes. It may be toxic.

A battery can present a risk of electrical shock and high short circuit current. The following precautions should be observed when working on batteries:

- 1. Remove watches, rings, or other metal objects.**
- 2. Use tools with insulated handles.**
- 3. Wear rubber gloves and boots.**
- 4. Do not lay tools or metal parts on top of batteries.**
- 5. Disconnect charging source prior to connecting or disconnecting battery terminals.**
- 6. Determine if battery is inadvertently grounded. If inadvertently grounded, remove source of ground. Contact with any part of a grounded battery can result in electrical shock. The likelihood of such shock will be reduced if such grounds are removed during installation and maintenance.**

Lead-acid batteries can present a risk of fire because they generate hydrogen gas. The following procedures should be followed:

- 1. DO NOT SMOKE when near batteries.**
- 2. DO NOT cause flame or spark in battery area.**
- 3. Discharge static electricity from body before touching batteries by first touching a grounded metal surface.**

2.3.1 Matching Battery Cabinets

1. **Cabinet Inspection.** Remove all panels and visually inspect the batteries, bus connections, and cabinet for any damage. **Exercise caution; voltage is present within the Battery Cabinet even before installation.** If there are signs of damage, do not proceed. Call Liebert Customer Service and Support at **1-800-543-2378**.
2. **Battery Storage.** The batteries used in the Battery Cabinet have an excellent charge retaining characteristic. The batteries can be stored for up to six months without any appreciable deterioration. Self-discharge rate of the batteries is approximately 3% per month when the batteries are stored in temperatures of 15°C to 25°C (59°F to 77°F). If the Battery Cabinet is planned to be stored for longer than six months, contact Liebert Customer Service for recommended action.
3. **Locating.** The Battery Cabinet can be located conveniently in or outside the computer room. The front-access-only design eliminates side and rear service clearance requirements. It also features top or bottom cable entry areas. However, there are several considerations to locating your new Battery Cabinet:
 - **Bolt-On Cabinets.** 22-inch wide matching battery cabinets are designed as a bolt-on section to the UPS module cabinet. They cannot be installed separate from the module.



CAUTION

A barrier panel must be placed between the 22 inch matching battery cabinet and the UPS module. The barrier must be installed utilizing the panel and hardware which is supplied with the 22 inch matching battery cabinet.

UPS-to-battery cabinet DC cables are provided by Liebert. See Figure 6.

- **Stand-Alone Cabinets.** 36-inch wide matching battery cabinets are designed as a stand-alone cabinet from the UPS module. Standard 36-inch wide battery cabinets include a manual disconnect and fuses. An optional battery circuit breaker is available which includes undervoltage release (UVR) and auxiliary contacts for control wiring connection to the UPS module. 36-inch wide battery cabinets can be connected in parallel for use with 65 to 125 kVA UPS modules by installation of separate power wiring connections between each battery cabinet and the DC bus bars in the UPS module cabinet. Control wiring must be connected between the UPS module and each optional battery circuit breaker, if provided. *UPS-to-battery cabinet power and control cables are provided by others. See Figure 7.*
- **Cable Distance.** The Battery Cabinet should be located as close as possible to the UPS cabinet to minimize voltage drop in the power cables. The maximum recommended distance is 100 cable feet (30 meters).
- **Service Clearance.** Allow front access to the Battery Cabinet at all times for maintenance and servicing. Electrical codes require that the Battery Cabinet be installed with no less than 3 feet (1 meter) of clearance at the front of the cabinet when operating. Side and rear panels do not require service clearance.
- **Environment.** Locate the Battery Cabinet in a clean, dry environment. Recommended temperature range for optimum performance and lifetime is 20°C (68°F) to 25°C (77°F).



CAUTION

To level battery cabinet, do not adjust leveling feet while they are supporting the cabinet weight. Use a pry bar or other external device to position and support the cabinet. Then adjust leveling feet and remove supporting device.

2.3.2 Non-Standard Batteries

When batteries other than a matching battery cabinet are used, the customer must purchase from Liebert a battery disconnect switch and overcurrent protection device rated for 500 VDC. Maximum permitted available fault current is 10,000 AIC.

1. Install battery racks/cabinets and batteries per manufacturer's installation and maintenance instructions.
2. Verify battery area has adequate ventilation and battery operating temperature complies with manufacturer's specification.

If you have any questions concerning batteries, battery racks, or accessories, contact Liebert Customer Service and Support at **1-800-543-2378**.

2.4 Electrical Wiring



WARNING

ALL POWER CONNECTIONS MUST BE COMPLETED BY A LICENSED ELECTRICIAN THAT IS EXPERIENCED IN WIRING THIS TYPE OF EQUIPMENT. WIRING MUST BE INSTALLED IN ACCORDANCE WITH ALL APPLICABLE NATIONAL AND LOCAL ELECTRICAL CODES. IMPROPER WIRING MAY CAUSE DAMAGE TO THE EQUIPMENT OR INJURY TO PERSONNEL. VERIFY THAT ALL INCOMING HIGH AND LOW VOLTAGE POWER CIRCUITS ARE DE-ENERGIZED AND LOCKED OUT BEFORE INSTALLING CABLES OR MAKING ANY ELECTRICAL CONNECTIONS.

Refer to **Table 2 - Site Planning Data, Series 300 UPS, 10 to 50 kVA** and **Table 3 - Site Planning Data, Series 300 UPS, 65 to 125 kVA**, and installation drawings (**Figure 1 through Figure 10**). Refer to **Table 5** and **Table 6** and **Figure 11** for wire termination data. Also refer to equipment nameplate for the model number, rating, and voltage so correct values are used from the tables associated with the drawings.

2.4.1 UPS Wire Size Guidelines

Proper wire sizing must be based on numerous site specific conditions. **Table 4**, a reprint of Table 310-16 of the NEC (National Electrical Code, NFPA 70, 1993, Copyright 1992), is included with permission of the National Fire Protection Association as a convenience to assist in determining the minimum size wires for your UPS application. Refer to notes **1** through **6** below, the present edition of the NEC, and all applicable local codes for your particular site requirements.

1. Refer to the Liebert chart or drawing that shows the ampacities for your UPS.
2. Input ampacity must be based on 125% of input current at full rated load plus 100% of battery charging current.
3. Be sure to refer to all requirements within Article 310 of the NEC.
4. Minimum sized grounding conductors are to be per NEC 250-95.
5. Neutral conductors are to be sized per NEC 310-16, note 10.
6. The UPS system must be installed in accordance with the present edition of the NEC and all local codes, including the codes of foreign countries where applicable.

2.4.2 Power and Control Wiring



WARNING

ALL POWER SHOULD BE TURNED OFF BEFORE ANY CABLES OR WIRES ARE INSTALLED OR CONNECTED. A QUALIFIED PERSON SHOULD CHECK TO INSURE THE POWER IS IN FACT "OFF".

1. Verify that power wiring is run in individual, separate conduit or cable tray. Verify that control wiring is run in individual separate steel conduit.



CAUTION

Power and control wiring must be separated!

2. Observe local, state, and national electrical codes. Verify utility power and its overcurrent protection rating will accommodate the UPS INPUT rating, including battery recharging.
3. A safety ground wire must be run from building ground to ground point in the UPS Module Cabinet, Battery Cabinet, External Maintenance Bypass Cabinet (if applicable), and Slim-Line Distribution (if applicable). The grounding conductor shall comply with the following conditions of installation:
 - a. An insulated grounding conductor that is identical in size, insulation material, and thickness to the grounded and ungrounded branch-circuit supply conductors except that it is green with or without one or more yellow stripes is to be installed as part of the branch circuit that supplies the unit or system.

-
- b. The grounding conductor described in item 1 is to be grounded to earth at the service equipment or, if supplied by a separately derived system, at the supply transformer or motor-generator set.
 - c. The attachment-plug receptacles in the vicinity of the unit or system are all to be of a grounding type, and the grounding conductors serving these receptacles are to be connected to earth ground at the service equipment.
 4. Observe clockwise phase rotation of all power wiring. Phase A leads Phase B leads Phase C. A qualified electrician should check the phase rotation.
 5. NEC Class 1 wiring methods are required for control and communication (Class 2) circuits.

2.4.3 Battery Wiring

The matching Battery Cabinet is designed for easy and convenient installation. Once the unit is located in final position, connect wiring between battery cabinet and UPS module. *DC cables are provided by Liebert for 22-inch wide matching bottom battery cabinets.*



CAUTION

Be sure the barrier between the UPS and 22 inch matching battery pack is in place. See Figure 6.

DC cables are provided by others for all other battery systems.

Power wiring to the Battery Cabinet connects positive, negative, and ground power cables from the Battery Cabinet to the associated UPS.

Connection of the UPS to the Battery Cabinet serves to both charge and discharge the batteries (when needed).



WARNING

MAKE SURE ALL POWER (AND CONTROL IF APPLICABLE) WIRING FROM THE UPS IS DE-ENERGIZED AND PROPERLY INSTALLED BEFORE CONNECTING TO THE BATTERY CABINET.

Cables to the Battery Cabinet should be sized for a maximum 2.0 volt total line loss at the maximum discharge current for the equipment. Refer to the **Table 2 - Site Planning Data, Series 300 UPS, 10 to 50 kVA** and **Table 3 - Site Planning Data, Series 300 UPS, 65 to 125 kVA** for maximum battery discharge current. A qualified licensed electrician can size the wiring for your installation using this information.



CAUTION

Be sure polarity is correct when wiring the Battery Cabinet to the connected equipment (positive to positive; negative to negative). If polarity is not correct, fuse failures or equipment damage can result.

Call Liebert Customer Service and Support at **1-800-543-2378** to schedule installation check-out, final battery intercell connections, and start-up.



CAUTION

A battery intercell connection on each tier is disconnected for safety during shipment. Do not complete these connections. The Liebert Customer Service Representative will complete these connections as part of start-up.



WARNING

DO NOT CONNECT THE DISCONNECT PLUG ON THE BATTERY CABINET UNTIL THE INSTALLATION HAS BEEN INSPECTED BY LIEBERT CUSTOMER SERVICE. AN IMPROPERLY INSTALLED UNIT CAN RESULT IN INJURY TO PERSONNEL OR DAMAGE TO EQUIPMENT.

Table 4 Table 310-16

Allowable Ampacities of Insulated Conductors Rated 0-2000 Volts, 60° to 90°C (140° to 194°F)¹

Not More than Three Conductors in Raceway or Cable or Earth (Directly Buried), based on Ambient Temperature of 30° (86°F)

Size	Temperature Rating of Conductor. See Table 310-13.						Size
	60°C (140°F)	75°C (167°F)	90°C (194°F)	60°C (140°F)	75°C (167°F)	90°C (194°F)	
AWG kcmil	Types TW† UF†	Types FEPW†, RH,RHW†, THHW†, THW†, THWN†, XHHW†, USE†, ZW†	Types TBS, SA, SIS,FEP†, FEPB†,MI, RHH†, RHW-2 THHN†,THHW†, THW-2,THWN-2, USE-2, XHH, XHHW† XHHW-2,ZW-2	Types TW† UF†	Types RH†, RHW†, THHW†, THW†, THWN†, XHHW†, USE†	Types TBS, SA,SIS, THHN†, THHW†, THW-2, THWN-2, RHH†, RHW-2, USE-2, XHH, XHHW†, XHHW-2, ZW-2	AWG kcmil
	Copper			Aluminum or Copper-Clad Aluminum			
18	14
16	18
14	20†	20†	25†
12	25†	25†	30†	20†	20†	25†	12
10	30	35†	40†	25	30†	35†	10
8	40	50	55	30	40	45	8
6	55	65	75	40	50	60	6
4	70	85	95	55	65	75	4
3	85	100	110	65	75	85	3
2	95	115	130	75	90	100	2
1	110	130	150	85	100	115	1
1/0	125	150	170	100	120	135	1/0
2/0	145	175	195	115	135	150	2/0
3/0	165	200	225	130	155	175	3/0
4/0	195	230	260	150	180	205	4/0
250	215	255	290	170	205	230	250
300	240	285	320	190	230	255	300
350	260	310	350	210	250	280	350
400	280	335	380	225	270	305	400
500	320	380	430	260	310	350	500
600	355	420	475	285	340	385	600
700	385	460	520	310	375	420	700
750	400	475	535	320	385	435	750
800	410	490	555	330	395	450	800
900	435	520	585	355	425	480	900
1000	455	545	615	375	445	500	1000
1250	495	590	665	405	485	545	1250
1500	520	625	705	435	520	585	1500
1750	545	650	735	455	545	615	1750
2000	560	665	750	470	560	630	2000
Correction Factors							
Ambient Temp °C	For ambient temperatures other than 30°C (86°F), multiply the allowable ampacities shown above by the appropriate factor shown below.						Ambient Temp °F
21-25	1.08	1.05	1.04	1.08	1.05	1.04	70-77
26-30	1.00	1.00	1.00	1.00	1.00	1.00	78-86
31-35	.91	.94	.96	.91	.94	.96	87-95
36-40	.82	.88	.91	.82	.88	.91	96-104
41-45	.71	.82	.87	.71	.82	.87	105-113
46-50	.58	.75	.82	.58	.75	.82	114-122
51-55	.41	.67	.76	.41	.67	.76	123-131
56-6058	.7158	.71	132-140
61-7033	.5833	.58	141-158
71-804141	159-176

† Unless otherwise specifically permitted elsewhere in this Code, the overcurrent protection for conductor types marked with an obelisk (†) shall not exceed 15 amperes for No. 14, 20 amperes for No. 12, and 30 amperes for No. 10 copper; or 15 amperes for No. 12 and 25 amperes for No. 10 aluminum and copper-clad aluminum after any correction factors for ambient temperature and number of conductors have been applied.

¹ Reprinted with permission from NFPA 70-1993, the National Electrical Code®, Copyright 1996, National Fire Protection Association, Quincy, MA 02269. This reprinted material is not the complete and official position of the National Fire Protection Association, on the referenced subject which is represented only by the standard in its entirety.

Table 5 Connection Type / Wire Size Range

Connection Type					
UPS Module Rating kVA	AC Input	Battery	Bypass Input & AC Output	Neutral	Ground
10 - 30	Compression lug #14 to #1/0	Compression lug #14 to #1/0	Compression lug #14 to #1/0	Compression lug #14 to #1/0	Ground studs 3/8" - 16 x 1.00" Lug required
40 - 50	Compression lug #6 to 250 kcmil	Compression lug #6 to 250 kcmil	Compression lug #6 to 250 kcmil	Natural studs 3/8" - 16 x 1.00" Lug required	Ground studs 3/8" - 16 x 1.00" Lug required
65 - 125	Bus bars (2" x 3-1/4") with connecting hardware (3/8") are provided for all power wiring terminations. A field-supplied lug is required.				

Use factory supplied connections for terminations where they are provided. Refer to **Figure 11** for field-supplied wiring termination details. Use commercially available UL listed solderless lugs for the wire size required for your application. Connect wire to the lug using tool and procedure specified by the lug manufacturer.

Table 6 Torque Specifications (Unless Otherwise Labeled)

Nut and Bolt Combinations				
Bolt Shaft Size	Grade 2 Standard		Electrical Connections with Belleville Washers	
	Lb-in	N-m	Lb-in	N-m
1/4	53	6.0	46	5.2
5/16	107	12.1	60	6.8
3/8	192	21.7	95	10.7
1/2	428	48.4	256	28.9

Terminal Block Compression Lugs (For Control Wiring)				
UPS Module Rating kVA	Wiring	Wire Size or Range	Lb-in	N-m
10 - 125	Control	#22 - #14	3.5 to 5.3	0.4 to 0.6
10 - 30	Power	#6 - #1/0	50	5.6
40 - 50	Power	#6	250	28.2
		250 kcmil	275	31.1

2.4.4 Wiring Connections

Verify the following connections have been made:

1. AC power cables from input power source (or optional external maintenance bypass cabinet) to UPS Module Input. (Observe A-B-C phase rotation.)

Standard Series 300 UPS modules are provided with an input auto transformer. If there are line-to-neutral loads connected to the UPS output, the input source must be wye connected and have three phases plus neutral plus ground.

If the Series 300 UPS module is provided with an optional input isolation transformer, an input neutral conductor is not required and the UPS can be fed from either delta or wye connected utility service.

2. DC power cables (positive and negative) from battery cabinet to UPS module DC bus (observe proper polarity).

When multiple conductors are used from the battery to the UPS module, it is necessary to run the same number of positive (+) and negative (-) cables in the same cable tray or conduit.

3. AC power cables from the UPS output to the critical load distribution (or optional external maintenance bypass cabinet, or optional slim-line distribution panel).

(Observe A-B-C Phase Rotation.)

The output source should have three phases, plus neutral (if line-to-neutral loads will be powered from the UPS output) plus ground.

4. Any additional special control wiring must be run in individual separate conduit.
5. UPS input and output neutral must be connected to only one common point in the UPS. This neutral line must be grounded at the source. (An input neutral is not required with the optional input isolation transformer.)



NOTE

Refer to 5.0 - System Options for instructions and drawings for optional components.

2.4.5 Wiring Inspection

1. Verify all power connections are tight.
2. Verify all control wire terminations are tight.
3. Verify all power wires and connections have proper spacing between exposed surfaces, phase-to-phase, and phase-to-ground.
4. Verify that all control wires are run in individual, separate, rigid steel conduit.

Figure 1 Single Line Diagram 10-125 kVA

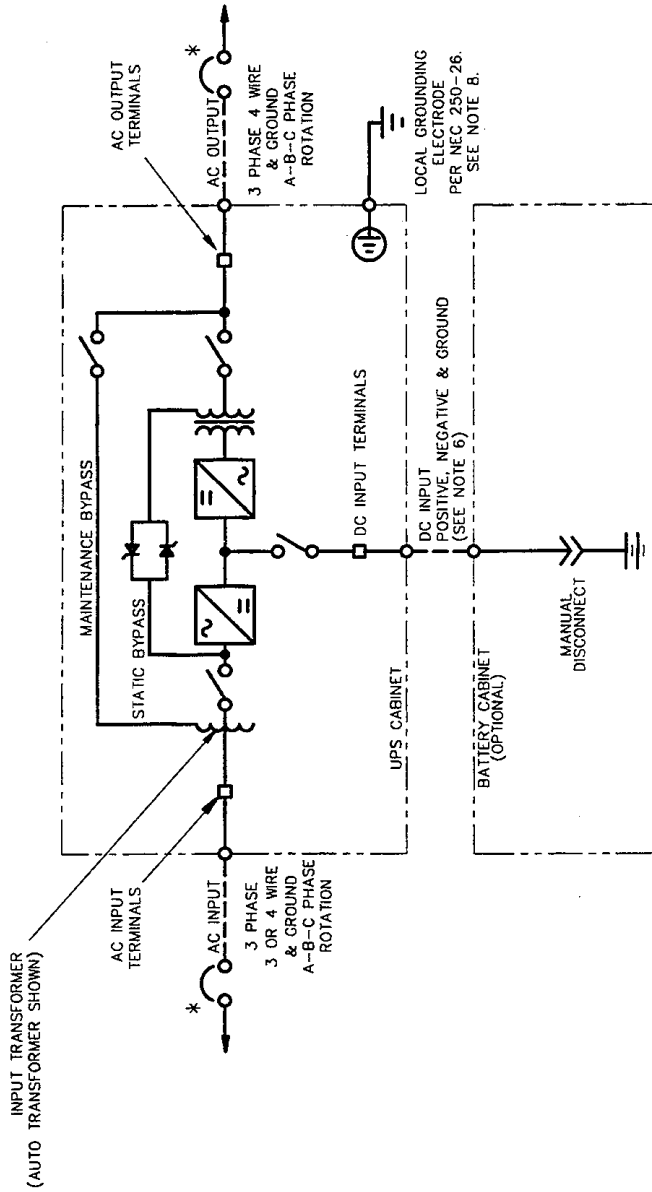

LEGEND
 --- FIELD SUPPLIED WIRING * EXTERNAL OVERCURRENT PROTECTION BY OTHERS
 --- FACTORY SUPPLIED WIRING

- NOTES:
1. NOMINAL (NOM) CURRENT IS BASED ON FULL RATED OUTPUT LOAD.
 2. MAXIMUM (MAX) CURRENT (125% OF NOMINAL) IS SHORT DURATION FOR BATTERY RECHARGE CONDITIONS.
 3. UPS INPUT CABLES MUST BE RUN IN SEPARATE CONDUIT FROM OUTPUT CABLE.
 4. IF THE UPS MODULE IS TO BE UPGRADED IN THE FUTURE, IT IS RECOMMENDED THAT THE AC INPUT, BATTERY, AND AC OUTPUT WIRING AND OVERCURRENT PROTECTION BE SIZED INITIALLY FOR THE FUTURE UPGRADED SIZE.
 5. NOMINAL BATTERY VOLTAGE IS SHOWN AT 2.0 VOLTS/CELL PER NEC 480-2.
 6. POWER CABLES FROM UPS DC LINK TO BATTERIES SHOULD BE SIZED FOR A TOTAL MAXIMUM 2.0 VOLT LINE DROP (MEASURED AT UPS) AT MAXIMUM DISCHARGE CURRENT. DC CABLES ARE PROVIDED FOR MATCHING 22" WIDE BOLT-ON FACTORY BATTERY PACK OPTIONS. DC CABLES ARE SUPPLIED BY OTHERS FOR ALL OTHER BATTERY PLANTS.

7. UPS OUTPUT LOAD CABLES MUST BE RUN IN SEPARATE CONDUIT FROM INPUT CABLES.
8. MINIMUM SIZED GROUNDING CONDUCTORS TO BE PER NEC 250-95. PARITY SIZED GROUND CONDUCTORS RECOMMENDED. NEUTRAL CONDUCTORS TO BE SIZED FOR FULL CAPACITY PER NEC 310-16. NOTE 10. UPS OUTPUT IS A SEPARATELY DERIVED SOURCE WHEN OPTIONAL INPUT ISOLATION TRANSFORMER IS PROVIDED. OUTPUT NEUTRAL IS BONDED TO EQUIPMENT GROUND THROUGH A JUMPER. REFER TO NEC ARTICLE 250 AND LOCAL CODES FOR PROPER GROUNDING PRACTICES.
9. AN INPUT NEUTRAL CONDUCTOR IS NOT REQUIRED WHEN THE OPTIONAL DELTA-WYE INPUT ISOLATION TRANSFORMER IS PROVIDED.
10. ALL WIRING IS TO BE IN ACCORDANCE WITH NATIONAL AND LOCAL ELECTRICAL CODES.
11. TOP OR BOTTOM CABLE ENTRY THROUGH REMOVABLE ACCESS PLATES. CUT PLATE TO SUIT CONDUIT SIZE THEN REPLACE.
12. CONTROL WIRING AND POWER WIRING MUST BE RUN IN SEPARATE CONDUIT.

TITLE		ONE-LINE DRAWING	
SERIES 300 UPS		DESIGN SERIES 25	
10 - 125 KVA UPS MODULES			
DRG. NO.	DATE	ORDER NO.	
LURT2002	11-7-94		



Figure 3 UPS Cabinet Installation Diagram 10-30 kVA

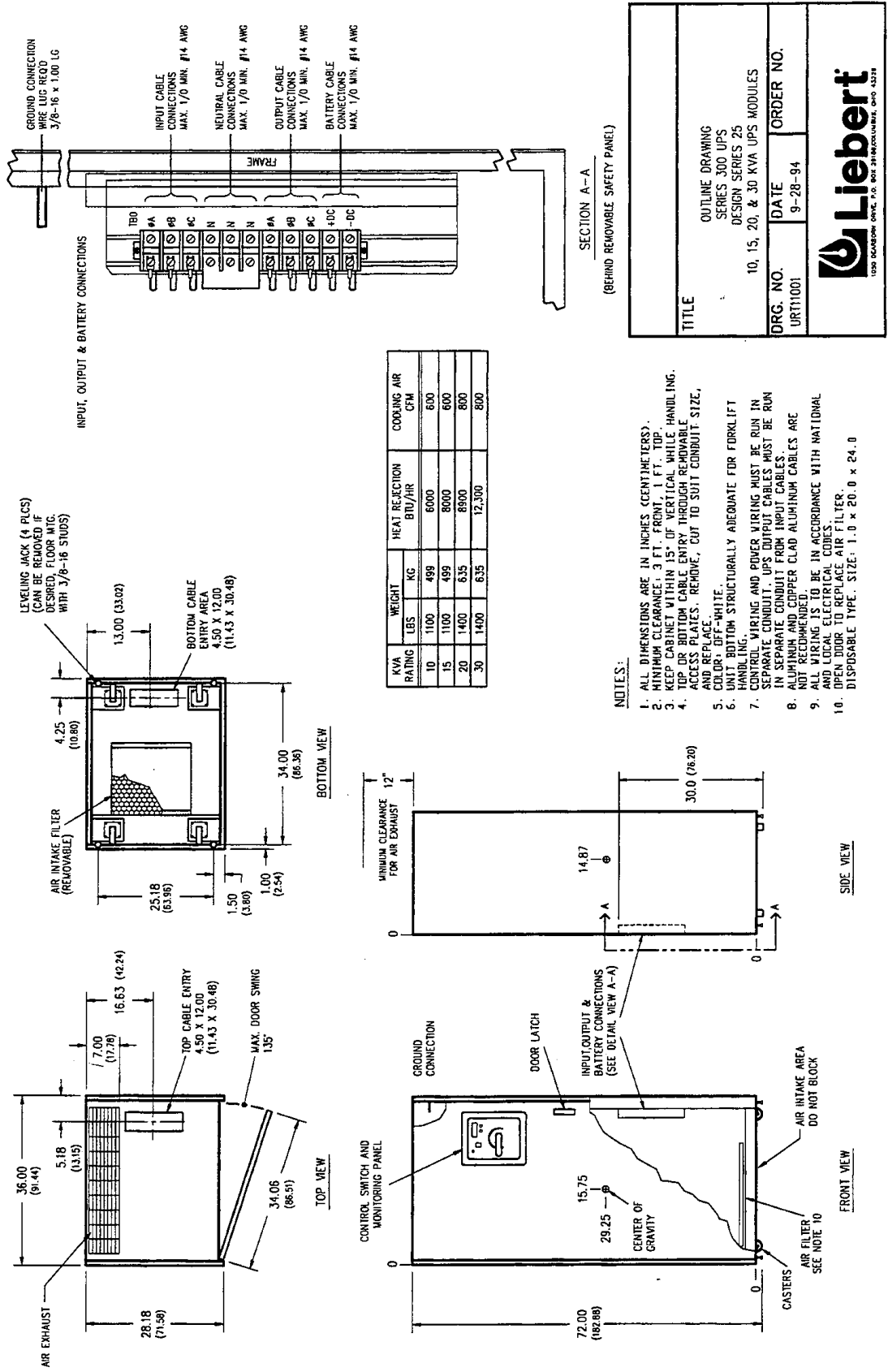

Figure 4 UPS Cabinet Installation Diagram 40-50 kVA

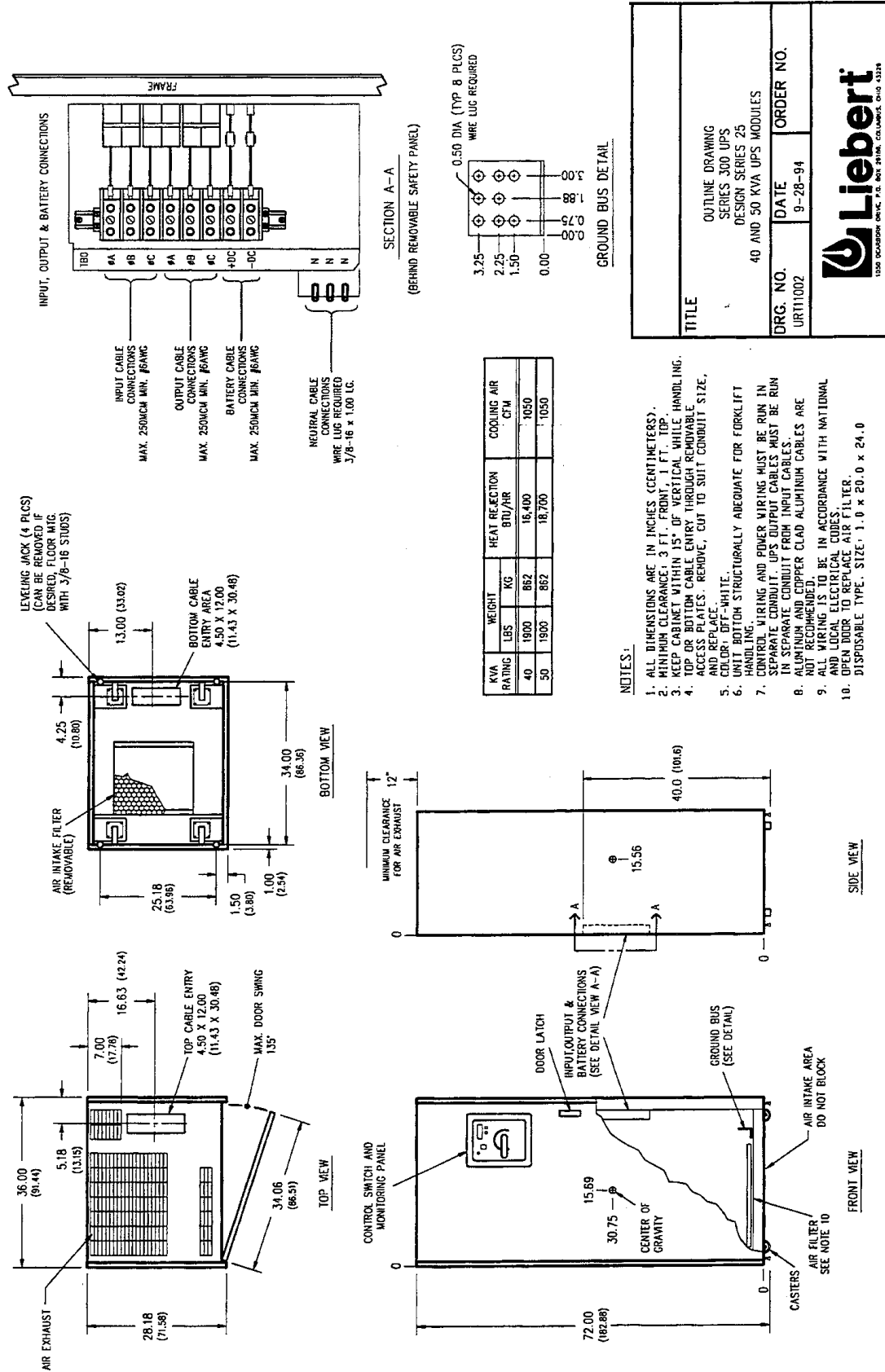
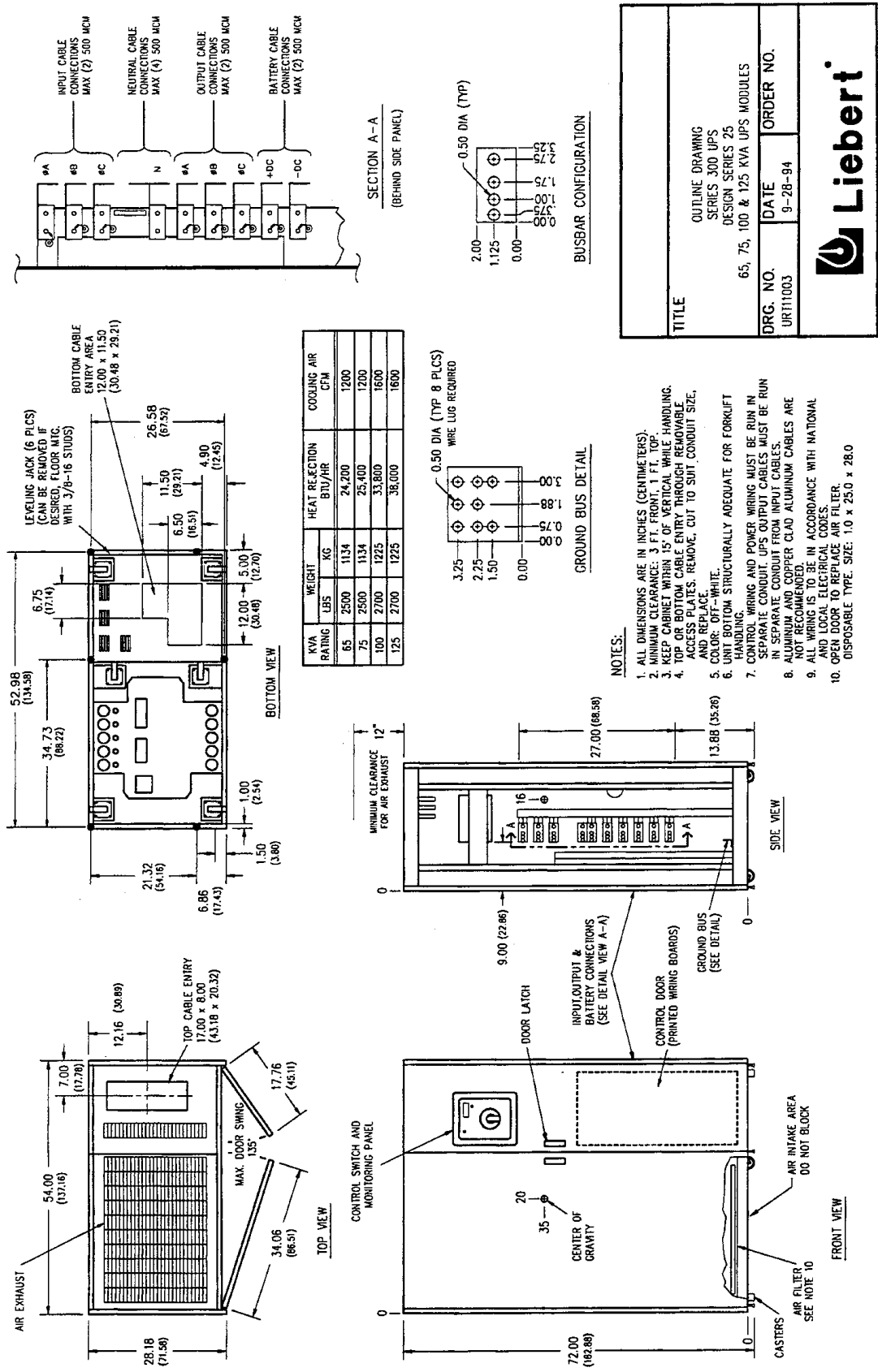

Figure 5 UPS Cabinet Installation Diagram 65-125 kVA



TITLE	
OUTLINE DRAWING SERIES 300 UPS DESIGN SERIES 25	
DRG. NO. URT11003	DATE 9-28-94
ORDER NO. 65, 75, 100 & 125 KVA UPS MODULES	

Liabert

Figure 6 Battery Cabinet Installation Diagram - 22-inch Frame

MODEL NUMBER	WEIGHT		WIDTH	
	LEBS	KG	IN	CM
URCB00140V25VJ	760	345	22.00	55.88
URCB00140H25VJ	1150	522	22.00	55.88
URCB00170V25VJ	1000	454	22.00	55.88
URCB00170H25VJ	1500	680	22.00	55.88
URCB00270V25VJ	1300	590	22.00	55.88
URCB00370V25VJ	1650	748	22.00	55.88
URCB00475V25VJ	2100	953	22.00	55.88

* AN "F" IN PLACE OF "0" IN THE 5th DIGIT OF THE MODEL NUMBER SPECIFIES THE BATTERY PACK IS EQUIPPED WITH FLAME RETARDANT BATTERY JAMS.

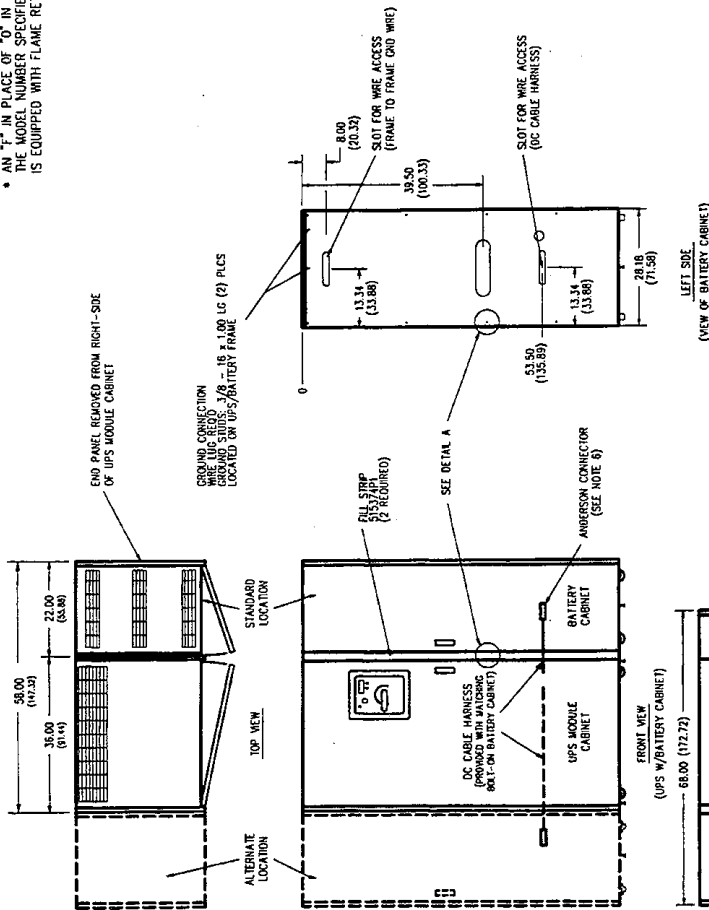
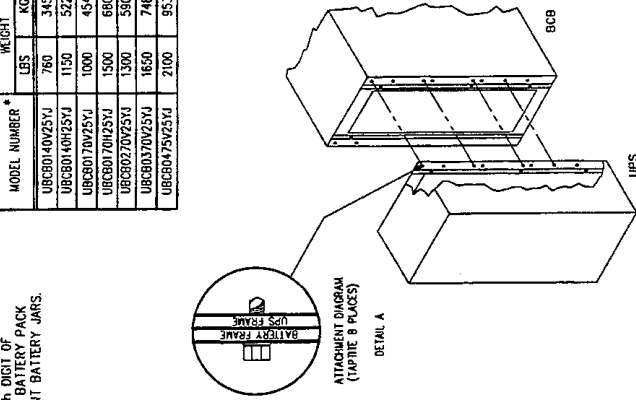

- NOTES:**
1. ALL DIMENSIONS ARE IN INCHES (CENTIMETERS).
 2. MINIMUM CLEARANCE: 3 FT. FRONT, 1 FT. TOP.
 3. KEEP CABINET WITHIN 15' OF VERTICAL WHILE HANDLING.
 4. STANDARD LOCATION FOR BATTERY CABINET IS RIGHT-SIDE OF UPS MODULE CABINET WITHOUT SLIM-LINE DISTRIBUTION, AND LEFT SIDE WITH SLIM-LINE DISTRIBUTION.
 5. WARNING: THE SHEETMETAL BARRIER MUST BE BETWEEN THE UPS MODULE AND THE BATTERY CABINET. IF BATTERY CABINET IS MOUNTED ON THE LEFT SIDE OF THE UPS (ALTERNATE LOCATION), THE SHEETMETAL BARRIER MUST BE REMOVED AND MOUNTED TO THE RIGHT SIDE OF THE BATTERY CABINET.
 6. CAUTION: DO NOT CONNECT TO MATING CONNECTOR FROM BATTERY DURING INSTALLATION. (THIS CONNECTION TO BE COMPLETED BY CUSTOMER SERVICE AT START-UP. CABLE HARNESS SHIPPED INSIDE BATTERY CABINET)
 7. COLOR: OFF-WHITE
 8. UNIT BOTTOM STRUCTURALLY ADEQUATE FOR FORKLIFT HANDLING.
 9. ALL WIRING AND COPPER CLAD ALUMINUM CABLES ARE NOT RECOMMENDED.
 10. ALL WIRING IS TO BE IN ACCORDANCE WITH NATIONAL AND LOCAL ELECTRICAL CODES.
 11. RECOMMENDED OPERATING TEMPERATURE RANGE: 20° C (68° F) TO 25° C (77° F)

TITLE		OUTLINE DRAWING 22" BATTERY CABINET SERIES 300 UPS	
DRG. NO.	DATE	ORDER NO.	
URT11004	9-28-94		
 <small>1000 KENNEDY DRIVE, P.O. BOX 3700, COLUMBUS, OHIO 43260</small>			

Figure 7 Battery Cabinet Installation Diagram - 36-inch Frame

PART NUMBER	OVERCURRENT PROTECTION AMP RATING	MAX. WIRE SIZE	UNIT WEIGHT	
			LBS	KG
UBCP_270H25JJ	150A	500 MCM (2)	2050	930
UBCP_310H25JJ	150A	500 MCM (2)	2500	1134
UBCP_370H25JJ	150A	500 MCM (2)	2750	1247
UBCP_475H25JJ	150A	500 MCM (2)	3500	1588
UBCP_310H25MJ	225A	500 MCM (2)	2050	930
UBCP_370H25MJ	225A	500 MCM (2)	2750	1247
UBCP_475H25MJ	225A	500 MCM (2)	3500	1588
UBPP_140V25FJ	100A	1/0	950	431
UBPP_170V25FJ	100A	1/0	1180	535
UBPP_270V25FJ	100A	1/0	1300	590
UBPP_370V25FJ	100A	1/0	1790	812
UBPP_475V25FJ	100A	1/0	2200	988
UBPP_140H25JJ	150A	3/0	1300	590
UBPP_170H25JJ	150A	3/0	1700	771
UBPP_270H25JJ	150A	3/0	2050	930
UBPP_310H25JJ	150A	3/0	2500	1134
UBPP_370H25JJ	150A	3/0	2750	1247
UBPP_475H25JJ	150A	3/0	3500	1588
UBPP_270H25MJ	225A	350 MCM	2050	930
UBPP_310H25MJ	225A	350 MCM	2500	1134
UBPP_370H25MJ	225A	350 MCM	2750	1247
UBPP_475H25MJ	225A	350 MCM	3500	1588
UBPP_270H25SJ	400A	250 MCM (2)	2050	930
UBPP_370H25SJ	400A	250 MCM (2)	2750	1247
UBPP_475H25SJ	400A	250 MCM (2)	3500	1588

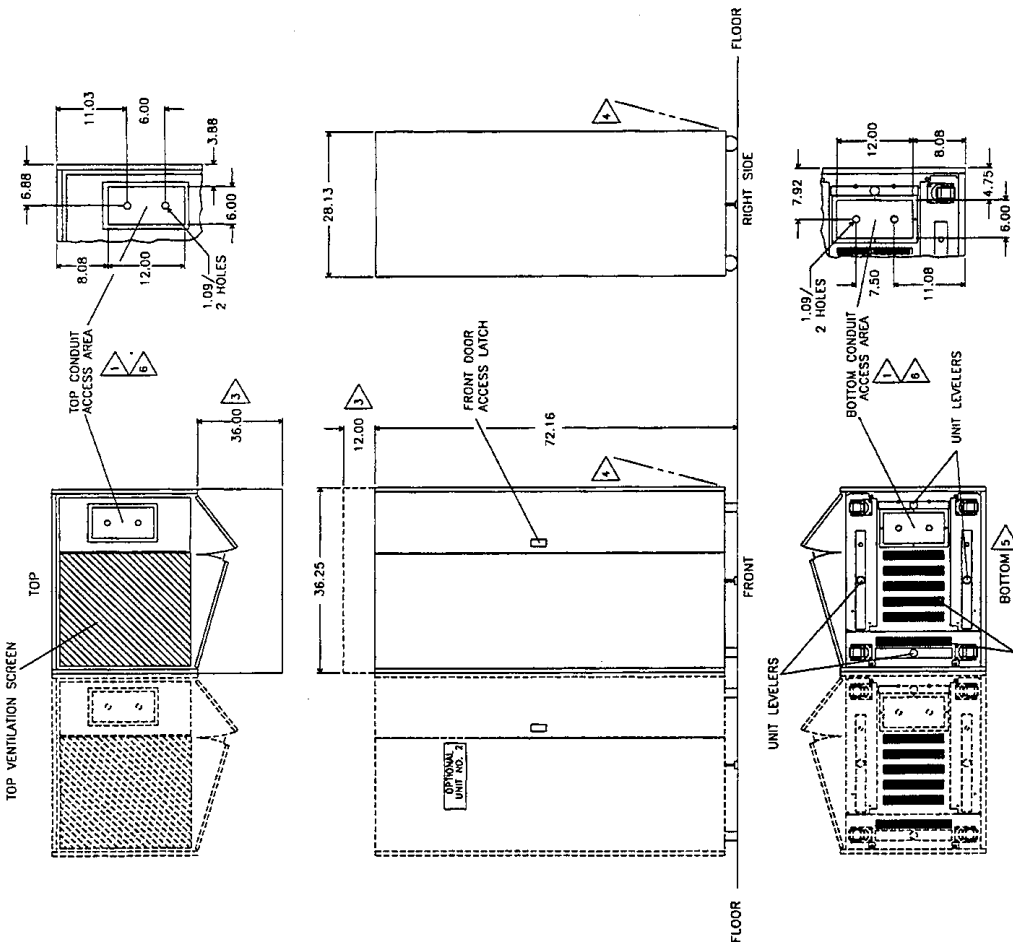

- NOTES:**
- SEPARATE CONDUIT MUST BE USED FOR CONTROL WIRING AND POWER WIRING.
 - A "0" IN THE FIFTH DIGIT INDICATES BATTERIES SUITABLE FOR INSTALLING IN AN OFFICE ENVIRONMENT; AN "F" INDICATES FLAME RETARDANT BATTERIES SUITABLE FOR INSTALLING IN A COMPUTER ROOM. NO SPECIAL VENTILATION IS REQUIRED.
 - MINIMUM ACCESS CLEARANCE IS 3 FT. FRONT 1.0 FT. TOP NO SIDE OR REAR ACCESS IS REQUIRED.
 - MAINTAIN UNIT WITHIN 15 DEGREES OF VERTICAL DURING HANDLING.
 - UNIT BOTTOM IS STRUCTURALLY ADEQUATE TO FACILITATE FORK LIFT HANDLING.
 - TOP AND BOTTOM CABLE ENTRY IS THROUGH REMOVABLE PLATES CUT TO FIT CONDUIT SIZE AND REPLACE.
 - ALL WIRING MUST BE IN ACCORDANCE WITH NATIONAL AND LOCAL ELECTRICAL CODES.
 - ALL SERVICE AND INITIAL CONNECTION OF BATTERIES MUST BE PERFORMED BY QUALIFIED SERVICE PERSONNEL.

TITLE	
OUTLINE DRAWING 36" BATTERY CABINET SERIES 300 UPS	
DRG. NO. URT11005	DATE 10-17-94
ORDER NO.	
 <small>1050 KRAMER RD. P.O. BOX 31180 COLUMBIA, MO 65231</small>	

Figure 7 Battery Cabinet Installation Diagram - 36-inch Frame (continued)

- NOTES:
1. ALL CONTROL WIRING (BY OTHERS) MUST BE RUN IN SEPARATE RIGID STEEL CONDUIT FROM POWER WIRING (BY OTHERS). CONTROL WIRING RUNS SHOULD NOT BE COMBINED IN THE SAME CONDUIT.
 2. ALL CONTROL WIRING TO BE #14 AWG STRANDED TINNED COPPER.
 3. ALL WIRING IS TO BE IN ACCORDANCE WITH NATIONAL AND LOCAL ELECTRICAL CODES.
 4. N.O. = NORMALLY OPEN
N.C. = NORMALLY CLOSED
C = COMMON
 5. BATTERY TERMINAL BLOCK KIT REQUIRES FIELD INSTALLATION. BATTERY TERMINAL RANGE IS TWO (2) #4-500 MCM PER POLARITY.
 6. FOR SYSTEMS WITH MULTIPLE PARALLEL BATTERY CABINETS WITH BATTERY CIRCUIT BREAKER, THE UVR FROM BATTERY CABINET #1 SHOULD BE WIRED TO THE CONTACT ISOLATOR BOARD AS SHOWN. THE UVR FROM BATTERY CABINET #2 AND ANY ADDITIONAL CABINETS SHOULD BE WIRED TO THE OPTIONAL POWER SUPPLY.

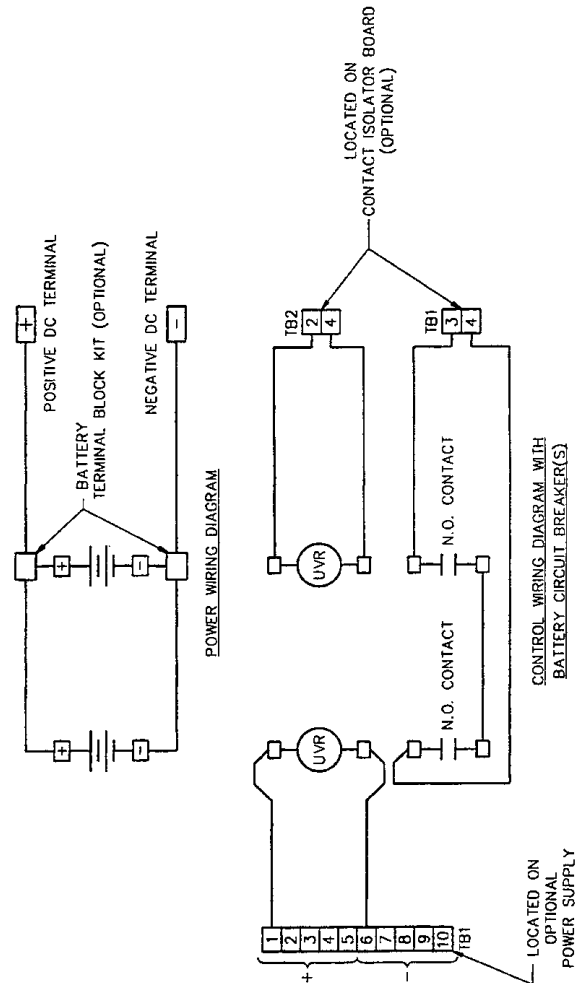
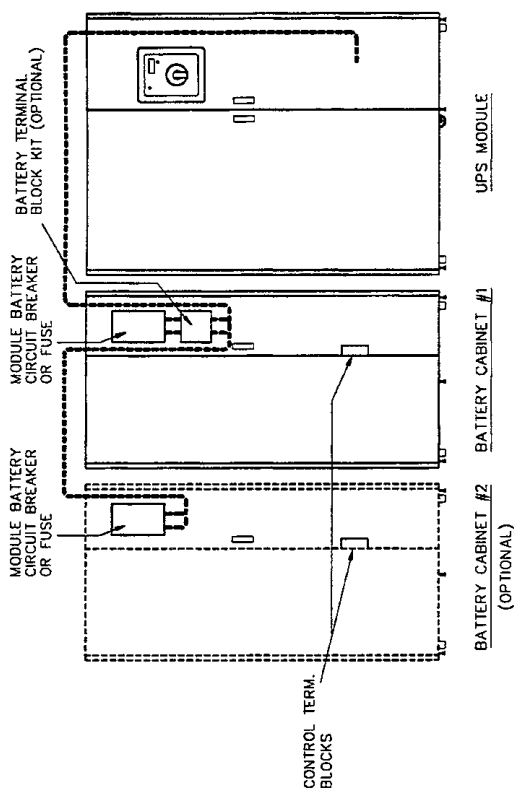

TITLE		INSTALLATION DRAWING 36" BATTERY CABINET SERIES 300 UPS	
DRG. NO.	DATE	ORDER NO.	
URT111006	2-13-95		
 <small>LIEBERT ELECTRONIC CORP. P.O. BOX 2186, COLUMBIA, MO 65201</small>			

Figure 8 Control Wiring Diagram 10-30 kVA

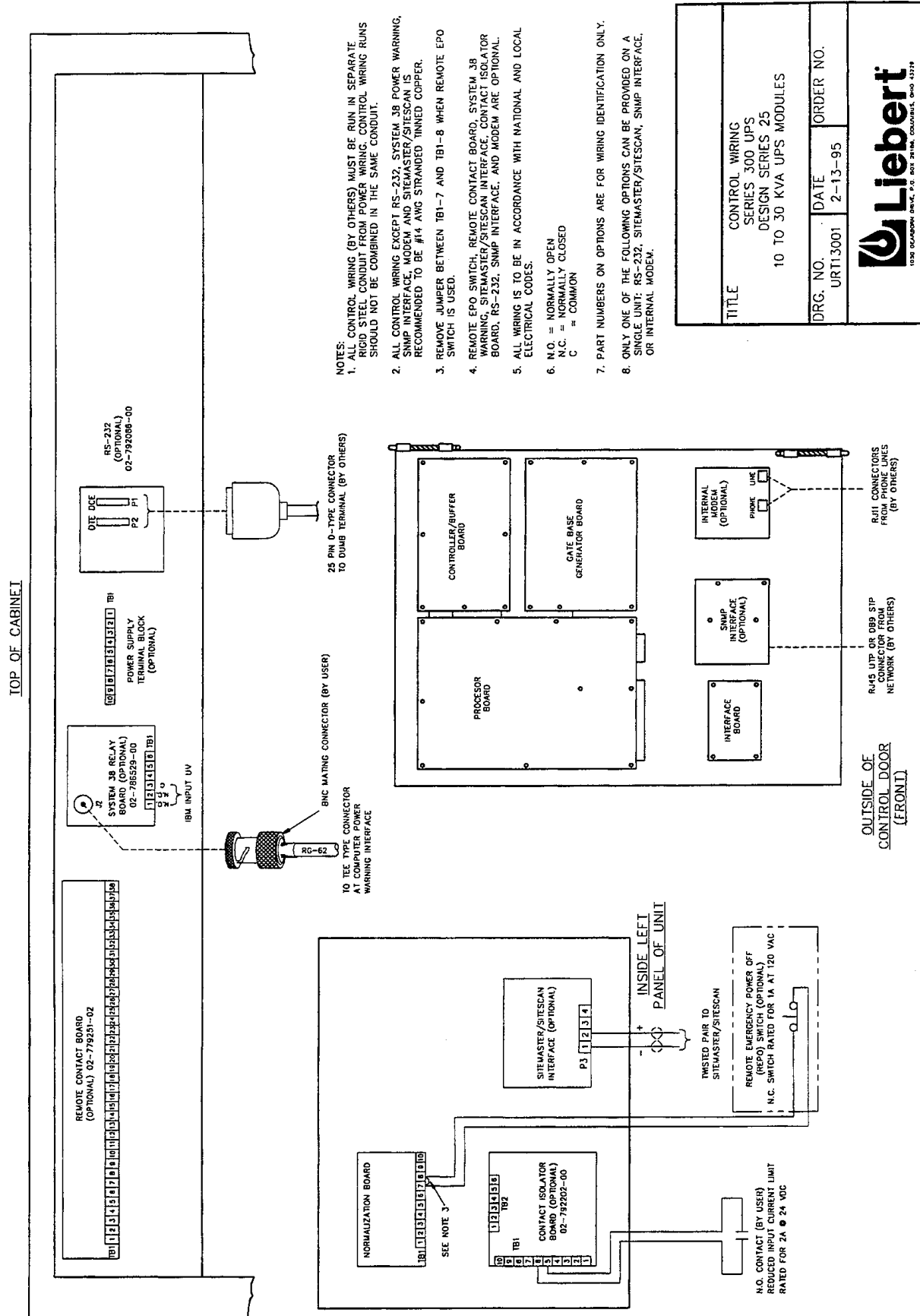
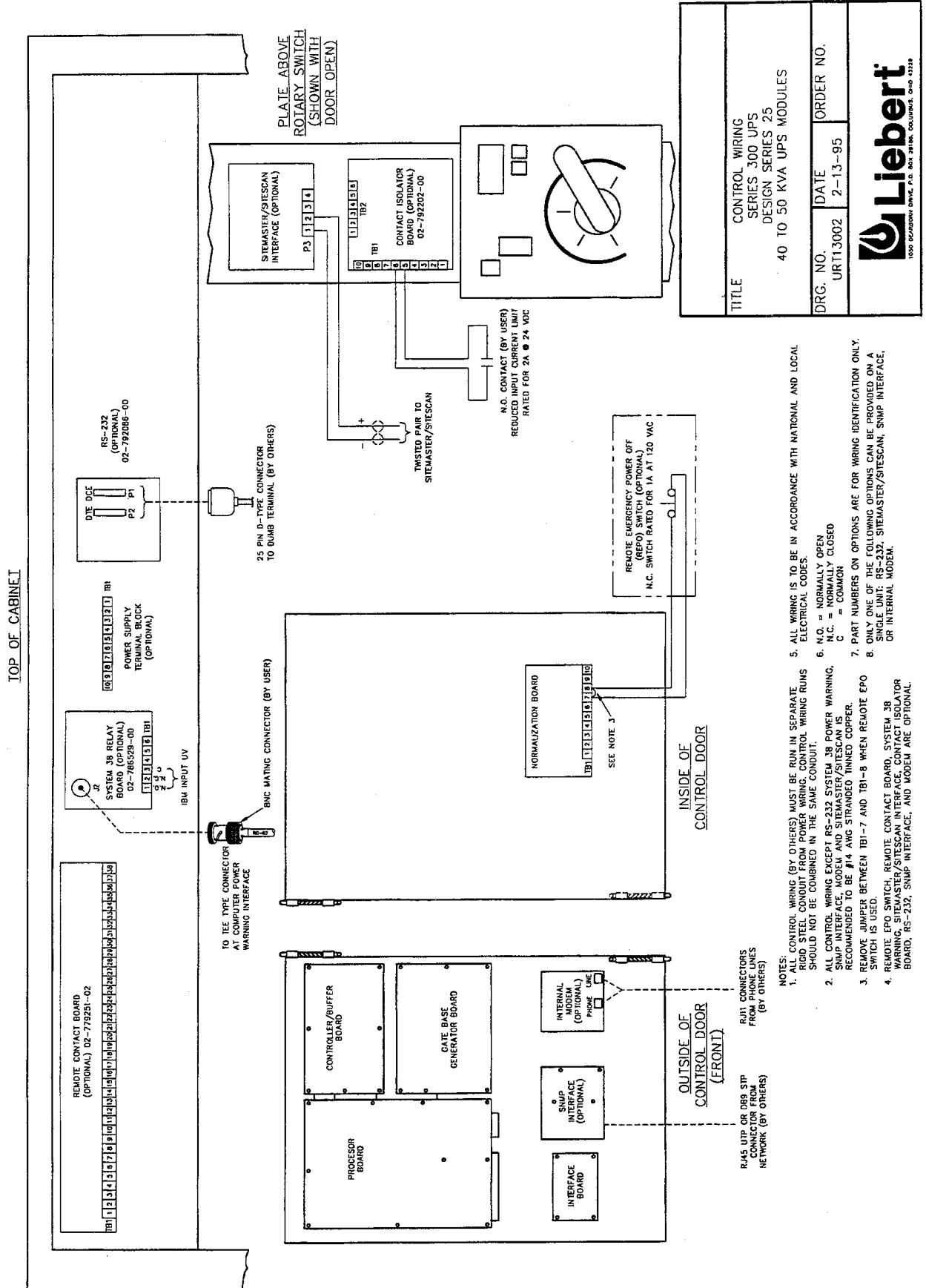

Figure 9 Control Wiring Diagram 40-50 kVA



TITLE		CONTROL WIRING SERIES 300 UPS DESIGN SERIES 25 40 TO 50 KVA UPS MODULES	
DRG. NO.	DATE	ORDER NO.	
URT13002	2-13-95		
		1000 DEPARTMENT DRIVE, P.O. BOX 218K, COVINGTON, OHIO 43001	

- NOTES:
- CONTROL WIRING (BY OTHERS) MUST BE RUN IN SEPARATE RIGID STEEL CONDUIT FROM POWER WIRING. CONTROL WIRING RUNS SHOULD NOT BE COMBINED IN THE SAME CONDUIT.
 - ALL CONTROL WIRING EXCEPT RS-232 SYSTEM 3B POWER WARNING, SNMP INTERFACE, MODEM, AND SITEMASTER/STESCAN IS RECOMMENDED TO BE #14 AWG STRANDED TINNED COPPER.
 - REMOVE JUMPER BETWEEN TB1-7 AND TB1-8 WHEN REMOTE EPO SWITCH IS USED.
 - REMOTE EPO SWITCH, REMOTE CONTACT BOARD, SYSTEM 3B WARNING, SITEMASTER/STESCAN INTERFACE CONTACT ISOLATOR BOARD, RS-232, SNMP INTERFACE, AND MODEM ARE OPTIONAL.
 - ALL WIRING IS TO BE IN ACCORDANCE WITH NATIONAL AND LOCAL ELECTRICAL CODES.
 - N.O. = NORMALLY OPEN
N.C. = NORMALLY CLOSED
C = COMMON
 - PART NUMBERS ON OPTIONS ARE FOR WIRING IDENTIFICATION ONLY.
 - ONLY ONE OF THE FOLLOWING OPTIONS CAN BE PROVIDED ON A SINGLE UNIT: RS-232, SITEMASTER/STESCAN, SNMP INTERFACE, OR INTERNAL MODEM.

Figure 10 Control Wiring Diagram 65-125 kVA

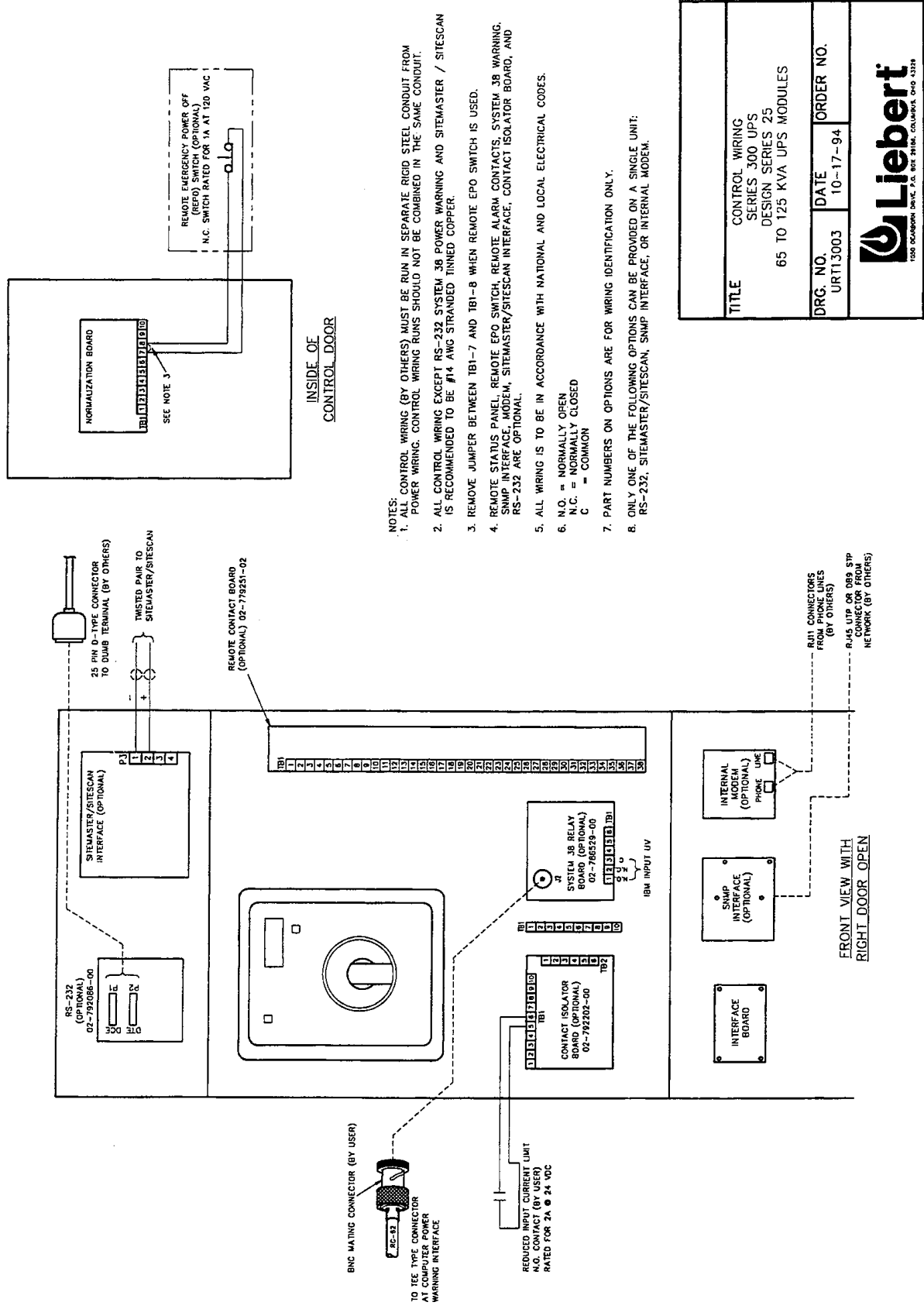

TITLE	
CONTROL WIRING SERIES 300 UPS DESIGN SERIES 25 65 TO 125 KVA UPS MODULES	
DRG. NO.	DATE
URT13003	10-17-94
ORDER NO.	
 <small>1500 BUCKINGHAM DRIVE, P.O. BOX 71146, COLUMBIA, SC 29274</small>	

Figure 11 Field Wiring Terminations

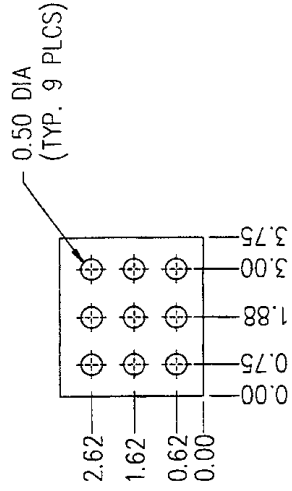

GROUND BUS DETAIL
(10 THRU 30 KVA)

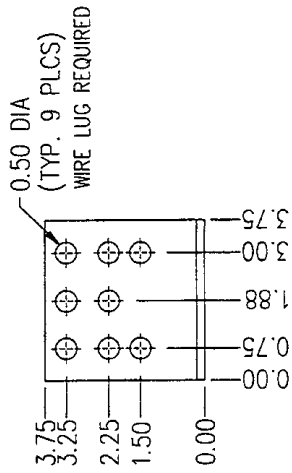

GROUND BUS DETAIL
(40 THRU 125 KVA)

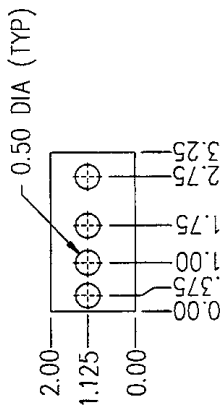

POWER CONNECTION
BUS BAR CONFIGURATION
(65 THRU 125 KVA)

TITLE		BUS BAR DETAIL SERIES 300 UPS DESIGN SERIES 25	
DRG. NO. URT21001	DATE 11-7-94	ORDER NO.	

Figure 11 Field Wiring Terminations (continued)

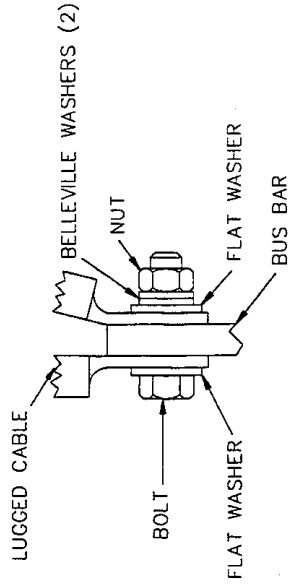

DUAL LUG CONNECTION DETAIL

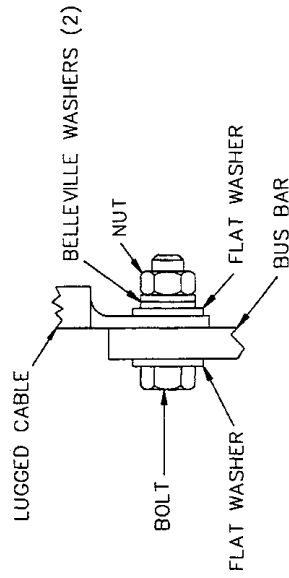

SINGLE LUG CONNECTION DETAIL

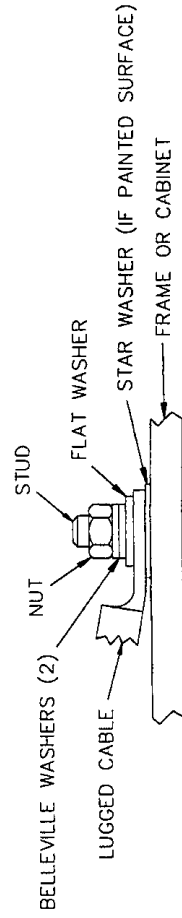

GROUND LUG CONNECTION DETAIL

TITLE		FIELD WIRING CONNECTIONS FOR LUGGED CABLES	
DRG. NO.	DATE	ORDER NO.	
URT21005	11-7-94		
 Liebert			

3.0 OPERATION

3.1 Operator Controls and Indicators

The Series 300 operator controls and indicators are located in one recessed panel on the UPS Module Cabinet door. See **Figure 12**.

The rectangular panel contains:

- Digital display screen and selection pads
- Power Status Diagram
- Rotary Switch and Advisory Display

3.1.1 Digital Display Screen

The display screen is composed of liquid crystals arranged in four lines of 16 characters each. See **Figure 14**. The internal control system executes programs which generate messages on this display screen. Screen messages instruct the user during start-up, operation, and shutdown. The screen also displays status information on request. See **Figure 14**. **Note that there is an internal control adjustment for LCD screen contrast. Have the control adjusted by the Liebert CS&S engineer during start-up.**

Figure 12 Operator Controls and Indicators on UPS Module Cabinet Front

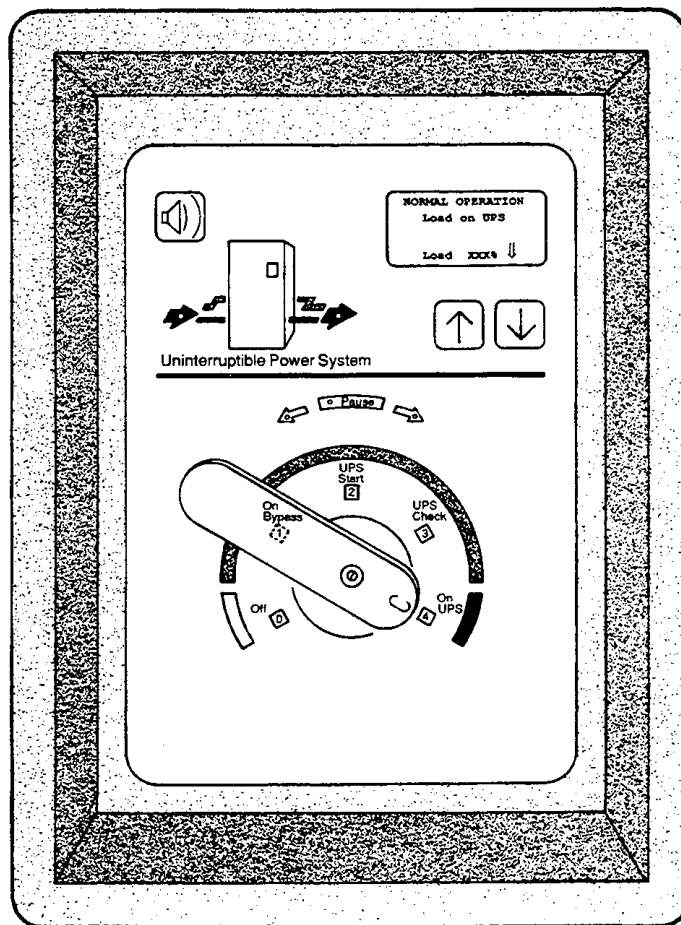
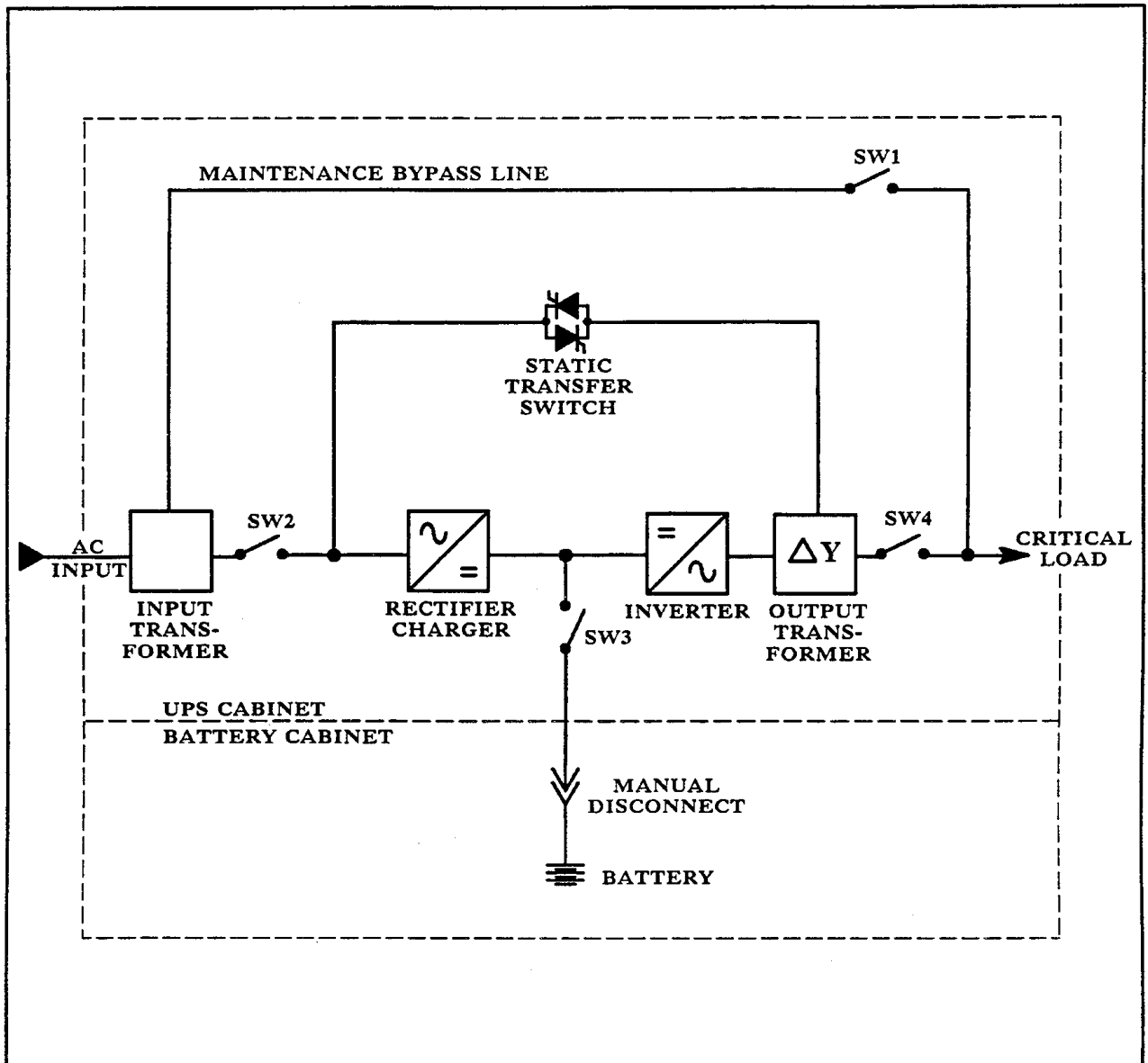

Figure 13 Block Diagram of the Series 300 UPS



ROTARY SWITCH POSITION	SW1	SW2	SW3	SW4
0	OPEN	OPEN	OPEN	OPEN
1	CLOSED	OPEN	OPEN	OPEN
2	CLOSED	CLOSED	OPEN	OPEN
3	CLOSED	CLOSED	CLOSED	OPEN
4	OPEN	CLOSED	CLOSED	CLOSED

3.1.2 Selection Pads

The three touch-sensitive selection pads are: Up, Down, and Alarm Silence. These pads are labeled with symbols rather than words. See **Figure 14**.

The Up and Down selection pads are located below the digital display screen. Use them to move through various menus present on the screen.

The Alarm Silence pad cancels the audible alarm which is emitted when an abnormal condition is detected. The Alarm Silence pad is also used to move through the various menus present on the screen.

You will use the Down pad more often than the Up pad. You do not need to press the Down pad several times to progress through the screens. Press and hold the Down pad, and the available screens will be displayed in the Down sequence.

Figure 14 Display Screen and Selection Pads

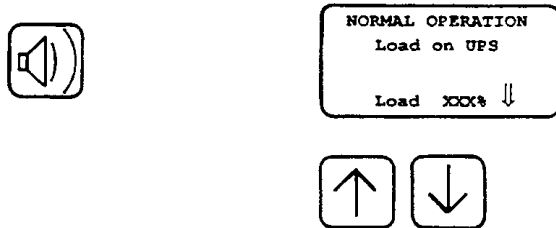

3.1.3 Power Status Diagram

The Power Status Diagram is located above the Rotary Switch. See **Figure 15**. It consists of a diagram with two LEDs to indicate flow of power from left (Input) to right (Output). Each LED is energized by a circuit connected to an AC power lead, and indicates that power is present (Input or Output). The Maintenance Bypass Line is represented by a yellow line; the UPS Module path is represented by a green line.

The Maintenance Bypass Line is a hard-wired line through the unit, from the utility, and provides no line conditioning or power protection. The Maintenance Bypass Line is represented by a yellow line that extends around the UPS. Note that the yellow Maintenance Bypass Line matches the Rotary Switch positions 1, 2, and 3 which are also colored yellow. This indicates that the load is receiving power through the Maintenance Bypass Line whenever the Rotary Switch is in position 1, 2, or 3. Both power LEDs are on.

When the Rotary Switch is in position 4 (green for Normal Operation), both LEDs are on whether the load is receiving conditioned power from the UPS or unconditioned power through the Static Bypass Line. When the battery supports the load during an input power failure, the Input LED is off while the Output LED is on.

Figure 15 Power Status Diagram

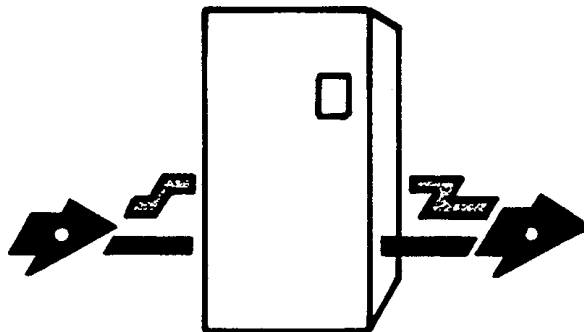

3.1.4 Rotary Switch

The Rotary Switch is located in the lower part of the recessed panel. This switch provides single-point control of the UPS. See **Figure 16**.



NOTE

Single-point control simplifies start-up and operation of the UPS. However, read instructions carefully before operating the Rotary Switch. Improper positioning of Rotary Switch could result in unwanted actions. Follow user prompts on display screen.

The five Rotary Switch positions are:

- Position 0, “Off”, disconnects all power to load; UPS is shut down. All alarms and indicators are inoperative; no power is supplied to the load through UPS.
- Position 1, “On Bypass”, connects the critical load to input power through the Maintenance Bypass Line. UPS Module is de-energized for maintenance purposes.
- Position 2, “UPS Start”, connects power to controls, rectifier/charger, inverter, and initiates tests on UPS components, while the load is supplied through the Maintenance Bypass Line.
- Position 3, “UPS Check”, connects the battery to the UPS and initiates tests on the battery, DC walk-in, and static bypass line, while the load is supplied through the Maintenance Bypass Line.
- Position 4, “On UPS”, connects the critical load to the UPS Module and establishes normal operation.



CAUTION

Do not operate Rotary Switch during a power failure. Doing so will result in an immediate loss of power to the load.

3.1.5 Advisory Display

The Advisory Display is located above the Rotary Switch and consists of:

- A band labeled “Pause”
- A clockwise (advance) arrow
- A counterclockwise (return) arrow

Each is highlighted with an LED. See **Figure 16**.

The Advisory Display guides operators through start-up and shutdown, as directed by the internal control system. The Advisory Display indicates (with illumination of the appropriate LED) whether to turn the Rotary Switch to the next clockwise position or to previous counterclockwise position. The Advisory Display also warns operators (with illumination of “Pause”) not to turn the Rotary Switch during start-up tests or during a power failure. All three Advisory Display LEDs extinguish when the Rotary Switch is to remain in Position 4 during normal operation.

Figure 16 Rotary Switch and Advisory Display

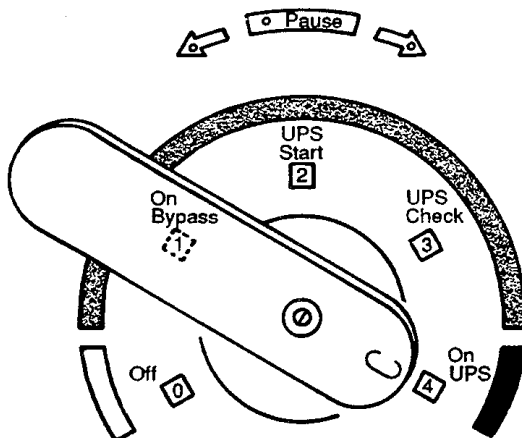

3.2 Display Screen Menu

Operating the UPS consists of observing the indicators on the operator control panel and making appropriate responses. Further UPS monitoring and testing can be achieved by moving through a series of menu selections present on the display screen. See **Figure 17**.

When input power is first applied to the UPS, the Display Screen displays a message prompting the operator to check the System Configuration and then to proceed to the Start-Up screens.

Once start-up is complete and normal conditions exist, the NORMAL OPERATION default screen message will be the only screen message displayed. This assures the operator that power to the load is being conditioned and backed up, and that no operator action is necessary.

Additional menu selections are available and are presented in a circular arrangement. They are categorized as follows: Alarm Messages, Meter Functions, Configuration Screens, Alarm History, and Lamp/Horn Test. To move between each category, simply press the Down, Up or Alarm Silence pad as prompted by the icon present in the lower right hand corner of each message screen.

Figure 17 Menu Selection Arrangement

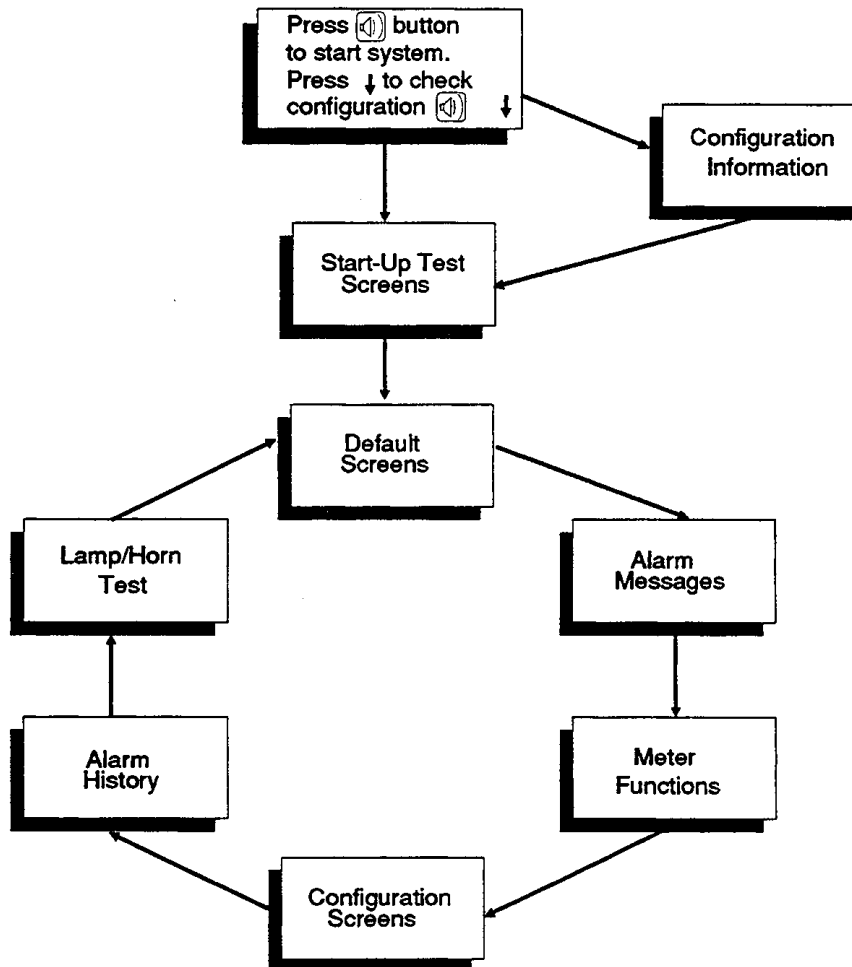

3.3 Default Screen Messages

One of six default messages will automatically appear on the display screen. They are:

- Normal Operation
- Warning Load on Maintenance Bypass
- Warning Load on UPS
- Warning Load on Static Bypass
- Fault: System Shutdown
- UPS on Battery

3.3.1 Normal Operation

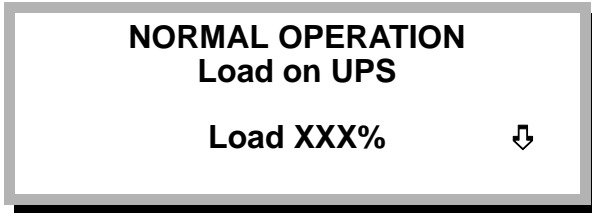

The NORMAL OPERATION message is displayed during normal operating conditions. It indicates:

- That system conditions are normal (all meter readings are nominal and the UPS Module is synchronized with the input power).
- That the critical load is supported by the UPS.
- The percentage of power being used by the critical load, relative to the UPS rating. The value represented by XXX will always be less than or equal to 100 in a NORMAL OPERATION message. (If the critical load is drawing more than 100% of the UPS rated load, a warning message will appear.)
- The Up, Down, or Alarm Silence symbol flashes in the lower right-hand corner of the screen. This is normal and indicates that the operator may cycle through various monitoring and test functions, by pressing the appropriate selection pad.

3.3.2 Warning: Load on Maintenance Bypass

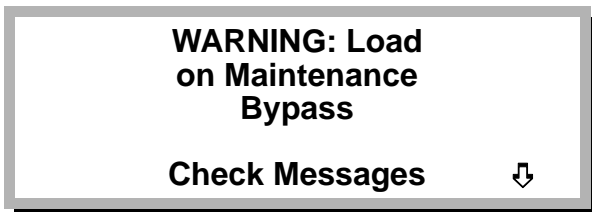

This message indicates that the critical load is being supplied power through the Maintenance Bypass Line. Press the Down pad to view the active Alarm Messages.



NOTE

Additional Alarm Messages may be active and can be viewed by pressing the Down pad. When the alarm condition is corrected, the message will be cleared from the message list (but will remain in the alarm history buffer). For a list of Alarm Messages with their meaning and recommended corrective actions, refer to 3.11 - Alarm Messages.

3.3.3 Warning: Load on UPS

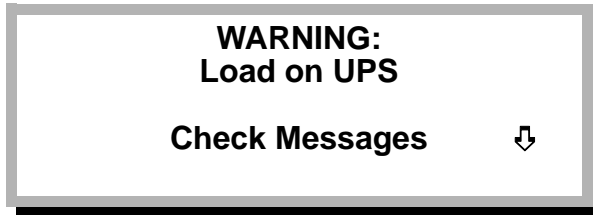

This message indicates that an alarm condition exists. However, the critical load is still receiving conditioned power through the UPS. Press the Down pad to view the Alarm Messages.

3.3.4 Warning: Load on Static Bypass



This message means the load has been automatically transferred from UPS Module output to Static Bypass Line because of an alarm condition. Press the Down pad to view the Alarm Messages.

3.3.5 Fault: System Shutdown

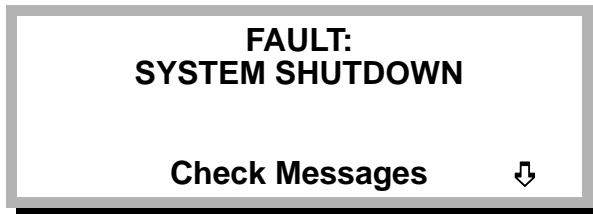

This message means the UPS has been shutdown by the internal control system. Press the Down pad to view the Alarm Messages and then perform a UPS start-up procedure after the alarm condition has been corrected.

3.3.6 UPS on Battery

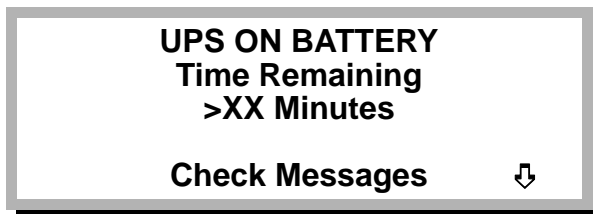

This message appears whenever the input power to the UPS is not available or is outside of specified limits. The load is being supported by the battery which has an estimated XX minutes of power remaining with the present connected load. Press the Down pad to view the Alarm Messages.

3.4 Alarm Messages

3.4.1 UPS Response to an Alarm

If the internal control system detects an abnormal condition:

1. An audible alarm will sound and the digital display will instruct you to Check Messages.



NOTE

After the audible alarm has been silenced (by pressing the Alarm Silence pad), the occurrence of another audible alarm indicates the existence of another abnormal condition.

2. An Advisory Display LED may illuminate, prompting you to turn the Rotary Switch in a corrective action (or not to turn the Rotary Switch at all).
3. An Alarm Message will be displayed on the Alarm Messages screen. Refer to **3.11 - Alarm Messages** for descriptions and recommended corrective actions.

3.4.2 Operator Response to an Alarm

1. Cancel the audible alarm by pressing the Alarm Silence pad.
2. Press the Down pad as prompted to view the Alarm Messages. Refer to **3.11 - Alarm Messages** for descriptions and recommended corrective actions. Call Liebert Customer Service and Support at **1-800-543-2378** if you require assistance.
3. Observe the default screen for the NORMAL OPERATION message or the display of additional instructions.
4. If a UPS start-up is required after correction of the alarm condition, refer to **3.6 - Start-Up**.

3.5 System Status Screens

Periodically, check the system status readings and compare them to the normal readings for your Series 300 UPS model. See **6.0 - Specifications**.

3.5.1 Meter Functions

To display various metering information during normal operating conditions, press the Down pad, from the NORMAL OPERATION default screen, until the following message appears:

```
LOAD: XXX%
A PHASE XXX kVA
B PHASE XXX kVA
C PHASE XXX kVA  ↓
```

Load. This screen shows the percent of rated power being used by the critical load. The load on each phase (A, B, and C) is also shown.

```
DC BUS
Voltage 410
Amps 15

Charging  ↓
```

DC Bus. This screen shows the voltage on the DC bus/battery. Battery current is also shown. (If the battery current indication is positive, the word Charging will appear on the screen. If the battery current is negative, the word Discharging will appear.)

```
INPUT A-PHASE
A - B XXX VOLTS
A - N XXX VOLTS
A XXX AMPS  ↓
```

Input. This Input screen is displayed for each phase of input power (phases A, B, and C). The screen displays the input line-to-line voltage (A-B, B-C, or C-A), line-to-neutral voltage, and current for that phase.

```
OUTPUT A-PHASE
A - B XXX VOLTS
A - N XXX VOLTS
A XXX AMPS  ↓
```

Output. This Output screen is displayed for each phase of output power (phases A, B, and C). The screen displays the output line-to-line voltage (A-B, B-C, or C-A), line-to-neutral voltage, and current for that phase.

```
FREQUENCY

60.0 Hz OUTPUT
60.0 Hz INPUT  ↓
```

Frequency. This screen displays the frequency of both the input and output power.

3.5.2 System Configuration

To display System Configuration information during normal operation conditions, press the Down pad until the following screen appears:



Use the selection pads to set customer adjustable site parameters when the appropriate screen is displayed. These include language, time, date, frequency slew rate, and low battery warning time. To make the adjustment:

- Press the Alarm Silence pad to begin the selection process. The digit to be selected will flash.
- Press the Up or Down pad to change the digit to the new value.
- Press the Alarm Silence pad to set your selection and move to the next digit or screen.
- Press the Down pad to cycle through the following System Configuration screens.



Language Selection. This screen enables the operator to choose from German, English, Spanish, French, or Italian. Press the Up, Down, and Alarm Silence pads simultaneously to return to English.



UPS Rating. This screen shows the UPS rating. The XXX indicates the UPS rating in kVA.

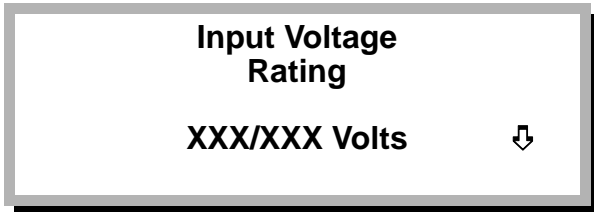

Input Voltage. This screen displays the UPS input voltage rating.

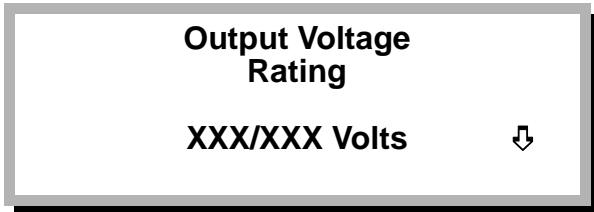

Output Voltage. This screen displays the UPS output voltage rating.

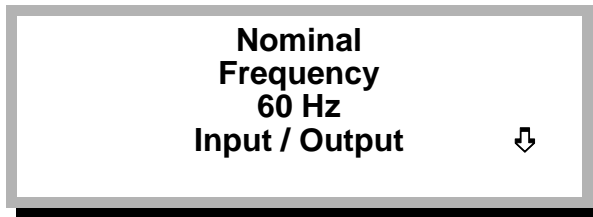

Nominal Frequency. Both input and output frequency ratings are shown on this screen.

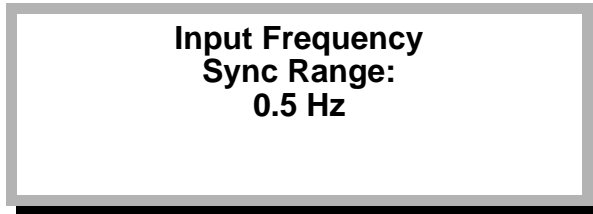

Input Frequency Sync Range. This screen displays the selected frequency tolerance. The input frequency synchronization range is adjustable (by internal control switches) and may be set at .5, 1, 3, or 5 Hz. The input power must be within this range for the UPS output to become synchronized with the input power. The UPS is shipped with this setting at 0.5 Hz.

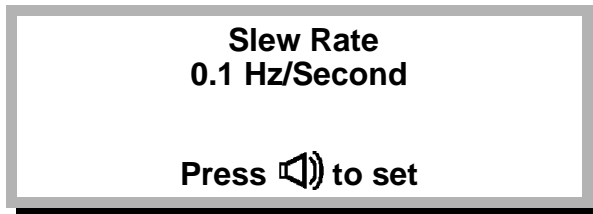

Slew Rate. This screen displays the selected frequency slew rate. The slew rate is adjustable (by the selection pads) in 0.1 Hz increments from 0.1 to 1.0 Hz per second (the recommended value is 0.1 Hz). The slew rate determines the tracking time the UPS inverter requires to match a new input frequency. For example, if the input frequency changes from 60 to 61 Hz, the UPS inverter frequency will eventually change to 61 Hz. The slew rate is the speed at which the frequency changes from 60 to 61 Hz.



Low Battery Warning. This screen shows the selected Low Battery Warning Time. This value is factory set at 5 minutes. However, it is adjustable (by the selection pads) in one minute increments from 1 to 99 minutes. When the UPS is operating on battery power, an Alarm Message will appear when this setting is reached. This warns the operator that battery shutdown is imminent.

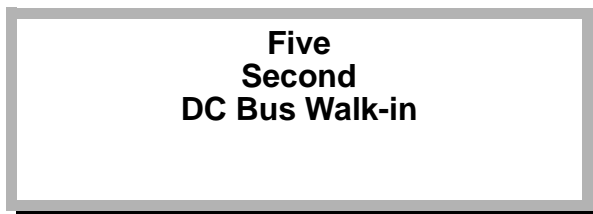

DC Bus Walk-in. This screen displays the current DC Bus Walk-in time. This setting is selectable (by internal control switch) to provide either a slow (20 seconds) or fast (5 seconds) ramp up time on the DC Bus. The UPS is shipped with this setting at 5 seconds.



Time and Date. This screen enables the operator to set the current time, day, and date. To change the current time and date settings, perform the following:

1. Press the Alarm Silence pad. The HH indication begins to flash.
2. Press the Up or Down pad to change setting.
3. Press the Alarm Silence pad to cycle through the remaining time and date settings.

Battery Test. The Series 300 UPS will automatically perform a scheduled on-line battery test if this feature is enabled by the user. During a test, the charger is turned off and the battery supplies power to the load for 30 seconds. The DC bus voltage is then compared to the setpoint. The user selects the scheduling of the tests, the DC voltage setpoint, and whether the test is enabled. The battery test can also be manually initiated by Liebert Customer Service and Support.

If the DC bus voltage remains above the setpoint, the battery has passed the test and a message is stored in the alarm history. The charger is turned down and normal UPS operation is resumed.

If the DC bus voltage decreases to the setpoint before the test is complete, the battery has failed the test and the UPS performs the following steps:

1. Transfer load to bypass.
2. Restart the charger.
3. Sound the audible alarm horn.
4. Display a battery warning message (note that the only way to clear this warning message is to perform a UPS start-up).
5. Record a battery test failed message.
6. Disable future battery tests.
7. Retransfer load to the UPS.

To schedule and enable this test, and to view or change the setpoint, push the Alarm Silence pad when the following screen appears:

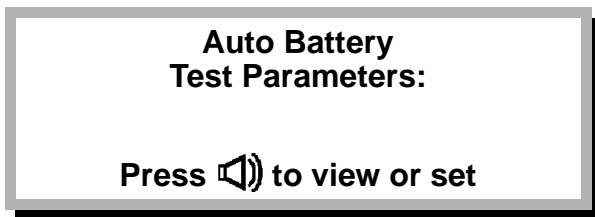

The Battery Parameter Screen will be displayed.

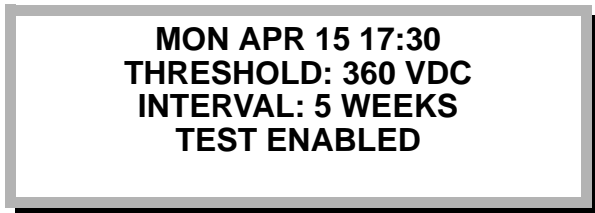

This screen displays test parameters and the date and time of the next scheduled test. During initial start-up, select preferred test day, date, time, threshold voltage setpoint, test interval, and enable or disable the automatic tests. Test interval is 2 to 9 weeks (factory set at 5). Use the Up, Down, and Alarm Silence pads to enter parameters. Note that if a scheduled test cannot be per-

formed because the load is not on the UPS, the test will automatically be scheduled for 1 week later.

Auto Restart. The UPS can restart the load after an extended power failure forces a load shutdown. As shipped from the factory, this feature is disabled. To enable the feature, locate the Auto Restart Status screen:



This setting can be either ENABLED or DISABLED. Use the UP, DOWN, and ALARM SILENCE buttons to change the value to ENABLED.

When power is reapplied after an automatic load shutdown, the UPS will restart the load 10 seconds after the power returns. While the UPS is restarting the load, it will execute self tests to verify that the major internal power and control sections are operating properly before transferring the load to the inverter. If any problems occur during this self test, the UPS will abort the tests and disable the load. The load can be powered manually by turning the power rotary switch to position 1, and a qualified service engineer should investigate the problem.



NOTE

When Auto Restart is enabled on Series 300 units which include optional battery circuit breakers, the unit will restart the load as described. However, to reconnect the battery, the battery circuit breaker(s) must be manually reset and closed.

3.5.3 Alarm History

The Series 300 UPS is equipped with a data buffer that records active Alarm Messages over a period of time. To view the Alarm History of the UPS, press the Down pad until the following screen appears:



Press the Alarm Silence pad to access the Alarm History screen. Press the Down pad to view the Alarm Messages.

The Alarm Messages are displayed in the reverse order of occurrence (beginning with the most recent). The time (to the 0.1 second) and date of occurrence is displayed with each Alarm Message. For a list of Alarm Messages with descriptions and recommended corrective actions, refer to **3.11 - Alarm Messages**.

3.5.4 Lamp Test

Periodically, the operator should verify that all segments in the LCD display screen are functioning.

From the NORMAL OPERATION default screen, press the Up pad or, press the Down pad from the Alarm History screen.

All LEDs illuminate for approximately 2 seconds and the horn sounds. The Input and Output LEDs on the Power Status Diagram are directly wired to their respective power lines and are not included in this test. When the test is complete, the screen will automatically display the appropriate default screen message.



NOTE

Note any LEDs not illuminated. Contact Liebert Customer Service and Support at 1-800-543-2378 to make appropriate repairs.

3.6 Start-Up

Start-up procedures are performed at the control panel located on the UPS Module Cabinet door. Prompted by the Advisory Display and screen messages, turn Rotary Switch to execute start-up.

3.6.1 Start-Up Procedure

Initial start-up must be performed by Liebert Service personnel. Start-up procedures described in this manual refer to a start-up of the UPS after a shutdown for maintenance or after an abnormal condition has been corrected. Depending on the situation, start-up may begin with Rotary Switch in Position 0 or Position 1. Begin at Step 1 or Step 4. Follow directions given in screen messages and the Advisory Display. Refer to **5.0 - System Options** if you have an External Maintenance Bypass Cabinet.



CAUTION

Start-up must be performed exactly as instructed. Follow prompts on the Advisory Display. Turning the Rotary Switch too soon or in the wrong sequence may result in immediate loss of power to the critical load.

Start-Up from Position 0

1. Verify Rotary Switch is set to Position 0.
2. Apply power to UPS from user's supply source (not part of the UPS).



WARNING

IN ROTARY SWITCH POSITION 1, UPS COMPONENTS ARE DE-ENERGIZED WITH THE EXCEPTION OF EMI CAPACITORS, ROTARY SWITCH, INPUT/OUTPUT TERMINALS, BATTERY CABINET, AND THE INPUT TRANSFORMER. ALL INPUT POWER MUST BE REMOVED TO ACHIEVE COMPLETE ISOLATION.

3. Turn Rotary Switch to Position 1. The following conditions exist:
 - a. Input power flows through Maintenance Bypass Line to critical load. This is a hard-wired line through the UPS; input power is not conditioned or backed up.
 - b. The Input and Output LEDs on the Power Status Diagram are illuminated. Meters and all other indicators are inoperative. (This is a maintenance position.)

Start-Up from Position 1

4. Turn Rotary Switch to Position 2. The following message will appear:

**Press  button
to start system.**

**Press  to check
configuration.**

Press Alarm Silence Pad as prompted. The control system begins executing internal tests. Meters and indicators are operative. Observe the following:

- Advisory Display “Pause” LED illuminates.
- Input power to critical load continues to be supplied through Maintenance Bypass Line as indicated by illuminated “Input” and “Output” LEDs on the Power Status Diagram.
- The screen displays the following self test messages. The XX in each screen indicates the seconds remaining in the test.

**STARTUP
Checking Input
power
[XX]**

**STARTUP
Testing charger
[XX]**

**STARTUP
Testing inverter
[XX]**

-
5. After the UPS has successfully passed the three previous tests, the following message will appear:



STARTUP
Test passed. Turn
rotary switch to
Position 3.

Advance the Rotary Switch to Position 3, as prompted. The battery is connected to the UPS Module, and the control system conducts internal tests on the battery (unless the battery test is disabled). The screen will display the following messages. The XX in each screen indicates the seconds remaining in the test.



STARTUP
Testing battery
[XX]



STARTUP
Testing walk-in
[XX]



STARTUP
Testing static
switch
[XX]

When the Position 3 tests are completed, the following message will appear:



STARTUP
Test passed. Turn
rotary switch to
position 4

6. Turn Rotary Switch to Position 4, which initiates UPS Module normal operation. Observe the following:
 - a. Advisory Display LEDs extinguish, indicating that the Rotary Switch will remain in Position 4 during normal operation.
 - b. The screen displays the following message:



STARTUP
Testing Input
synchronization
[XX]

This screen indicates the UPS is temporarily using the Static Bypass Line to supply power to the critical load.

The XX in this screen indicates the number of seconds elapsed while the UPS internal control system synchronizes the inverter with the input power.

When the inverter is synchronized, the control system automatically retransfers the critical load from the Static Bypass Line to the UPS Module, with no interruption of power to the load. The following default message will appear:



NORMAL OPERATION
Load on UPS

Load XXX% ↓

The NORMAL OPERATION message indicates the following:

1. The system status is normal (all meter readings are nominal and the UPS Module is synchronized with the input power).
2. The critical load is being supplied conditioned power through the UPS Module.
3. The power being supplied to the critical load is indicated as a percentage of the UPS power rating.
4. The Up, Down, or Alarm Silence symbol flashes in the lower right-hand corner of the screen. This is a normal indication and means that you may cycle through various monitoring, and test functions by pressing the appropriate selection pad.

Start-up is complete when the NORMAL OPERATION message appears. No further actions are required of the operator unless an abnormal condition occurs.

3.6.2 Abnormal Conditions During Start-Up

If the system detects an abnormal condition during start-up:

1. An Advisory Display LED may illuminate, prompting movement of the Rotary Switch. Read the screen message before turning the Rotary Switch.
2. The screen displays an abnormal condition message. See **Table 7** for an explanation of displayed messages and implement the corresponding corrective action.
3. Repeat start-up sequence if abnormal condition can be cleared. Call Liebert Service and Support if you require assistance.

During start-up, system components are tested and any abnormal conditions are displayed in an Alarm Message. When an abnormal condition occurs during start-up, the critical load continues to receive power through the Maintenance Bypass Line. If the default screen instructs you to Check Messages, press the Down pad to see the active Alarm Messages.

Table 7 shows Alarm Messages you may see during start-up, along with operator corrective action. Alarm Messages you may see during normal operation are in **3.11 - Alarm Messages (Table 8)**. Contact Liebert Customer Service and Support at **1-800-543-2378** if you require assistance.

Table 7 Alarm Messages During Start-Up

Alarm Message	Meaning and Corrective Action in Brackets []
START-UP SEQUENCE ABORTED	Check Messages.
Input phase rotation incorrect	The power conductors are not wired to the UPS input in the desired sequence. [Disconnect power from the UPS input and correct the wiring. A Liebert Customer Service and Support representative must be present during initial start-up of your UPS system.]
Incorrect input frequency	The frequency of the input power is outside the specified acceptable range. [Check your utility source.]
Rotary switch is in the wrong position	Power has been applied to the UPS with the Rotary Switch in the wrong position. This message is displayed when the input power is removed, the battery is discharged, and the UPS system has completely shut down. This message indicates the Rotary Switch is still in Position 4 when input power is restored. [Turn the Rotary Switch to Position 1 and perform a UPS start-up procedure.]
Rotary switch improperly operated	The Rotary Switch has been operated improperly. This means the switch has been operated either too fast or in the wrong direction. [Turn the Rotary Switch to Position 1 and perform a UPS start-up procedure.]
Battery Failed Test	The Start-up test routine has detected a failure in the battery. [Contact Liebert Customer Service and Support at 1-800-543-2378.]
Static Switch Failure	The Start-up test routine has detected a failure in the Static Transfer Switch. [Contact Liebert Customer Service and Support at 1-800-543-2378.]

3.6.3 Response to an Incorrect Start-Up Sequence

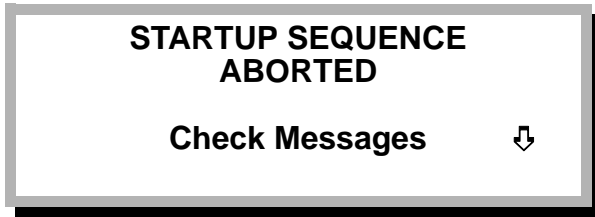

CAUTION

Start-up must be performed exactly as instructed. Follow prompts on the Advisory Display. Turning the Rotary Switch too soon or in the wrong sequence may result in immediate loss of power to the critical load.

1. If Rotary Switch is advanced through start-up before the appropriate system prompts, the following message is displayed:

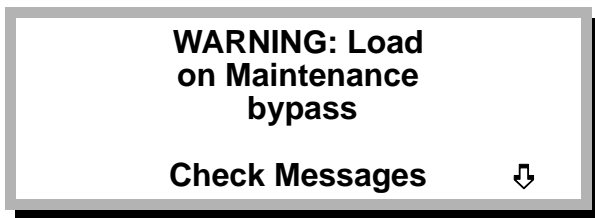

2. Press the Down selection pad (as prompted by the flashing arrow in the lower right-hand corner) to view the following message:

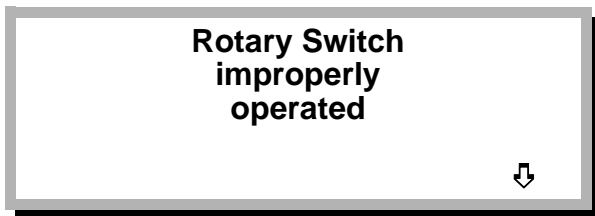

3. Turn rotary switch counterclockwise to Position 1. Do not turn rotary switch to Position 0. Doing so will cause an immediate loss of power to the load.



WARNING

CRITICAL LOAD IS CONNECTED TO THE MAINTENANCE BYPASS LINE AS SOON AS THE ROTARY SWITCH IS TURNED FROM POSITION 4 TO POSITION 3. HOWEVER, POWER REMAINS IN THE UPS, AND IS UNSAFE FOR MAINTENANCE UNTIL THE ROTARY SWITCH IS IN POSITION 1. IN POSITION 1, UPS COMPONENTS ARE DE-ENERGIZED WITH THE EXCEPTION OF EMI CAPACITORS, ROTARY SWITCH, INPUT/OUTPUT TERMINALS, BATTERY CABINET, AND THE INPUT TRANSFORMER. ALL INPUT POWER MUST BE REMOVED TO ACHIEVE COMPLETE ISOLATION.

4. From Position 1, repeat start-up sequence beginning with Step 3, observing the pace set by the Advisory Display and screen messages.

If repeated start-up attempts are unsuccessful, call Liebert Customer Service and Support at 1-800-543-2378.

3.7 Normal Operation

The NORMAL OPERATION default message is displayed during normal operating conditions. It indicates:

- System conditions are normal (all meter readings are nominal and the UPS Module is synchronized with the input power).
- The critical load is supported by the UPS Module.
- The amount of power being used by the critical load, relative to the UPS rating. The value represented by XXX will always be less than or equal to 100 in a NORMAL OPERATION message. (If the critical load is drawing more than 100% of the UPS rated load, a warning message will appear.)
- The Up, Down or Alarm Silence flashes in the lower right-hand corner of the screen. This is normal and indicates that the operator may cycle through various monitoring and test functions, by pressing the appropriate selection pad.

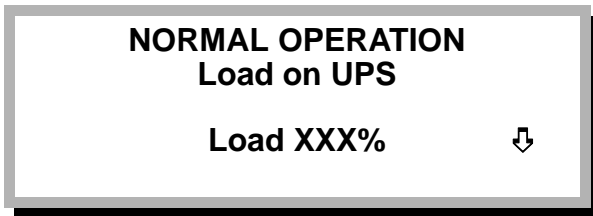

3.8 Shutdown

3.8.1 Shutdown to Maintenance Bypass

To remove the UPS from service for maintenance or other reasons and still provide power to the critical load, it is necessary to connect the load to the Maintenance Bypass Line by performing **Steps 1 and 2**, below (refer to **5.0 - System Options** if you have an External Maintenance Bypass Cabinet):

1. Turn Rotary Switch counterclockwise from Position 4 to Position 3, and observe the following message:

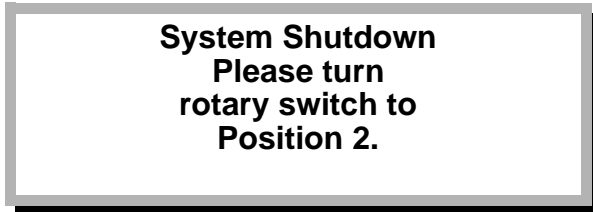

WARNING

CRITICAL LOAD IS CONNECTED TO THE MAINTENANCE BYPASS LINE AS SOON AS THE ROTARY SWITCH IS TURNED FROM POSITION 4 TO POSITION 3. HOWEVER, POWER REMAINS IN THE UPS, AND IS UNSAFE FOR MAINTENANCE UNTIL THE ROTARY SWITCH IS IN POSITION 1. IN POSITION 1, UPS COMPONENTS ARE DE-ENERGIZED WITH THE EXCEPTION OF EMI CAPACITORS, ROTARY SWITCH, INPUT/OUTPUT TERMINALS, BATTERY CABINET, AND THE INPUT TRANSFORMER. ALL INPUT POWER MUST BE REMOVED TO ACHIEVE COMPLETE ISOLATION.

2. Continue turning the switch counterclockwise to Position 1. Do not turn Rotary Switch to Position 0. Doing so will cause an immediate loss of power to the load. There is no power to the UPS Module control system in this position. Therefore, the digital display will be blank.

3.8.2 Complete Shutdown

To remove all power to the load, perform **Steps 1 and 2** above, then (refer to **5.0 - System Options** if you have an External Maintenance Bypass Cabinet):

3. Turn Rotary Switch from Position 1 to Position 0.

3.8.3 Emergency Shutdown

In the unlikely event an emergency shutdown is necessary, the operator should: Turn the Rotary Switch counterclockwise directly to Position 0. Refer to **5.0 - System Options** if you have an External Maintenance Bypass Cabinet.



CAUTION

All power will be disconnected from the critical load and UPS.

1. Call Liebert Customer Service and Support at **1-800-543-2378**.
2. To restart the UPS after the cause of the emergency shutdown has been corrected, perform the start-up procedure.

3.9 Response to a Power Failure

If input power fails while the load is on UPS (Rotary Switch in Position 4), the UPS battery will supply power to the inverter which supports the load.

3.9.1 UPS Response

1. UPS battery begins supplying power without interruption to the inverter.
2. The Input LED on the Power Status Diagram extinguishes. The Output LED remains illuminated.
3. The “Pause” LED on the Advisory Display illuminates, warning operator not to turn the Rotary Switch.



CAUTION

Movement of Rotary Switch during a power failure will result in an immediate loss of power to the load.

4. The audible alarm will sound if the power failure lasts longer than 10 seconds.
5. The screen displays the following message:

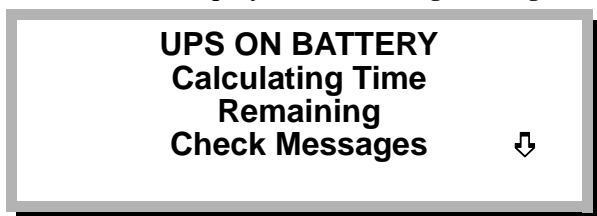

The internal control system begins sensing actual charge in the battery in order to calculate the amount of time the battery can support the critical load. The initial process of sensing and calculation requires approximately four minutes.

6. After the initial calculation process, the following message will appear:

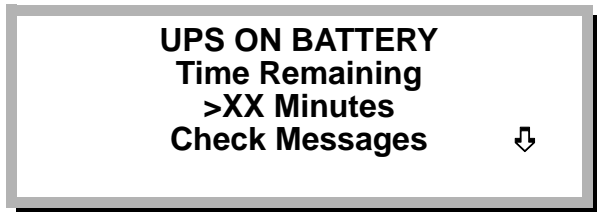

The time remaining number (reported in the “XX” field) will be the calculated battery time remaining. Thereafter, the process of sensing and re-calculation will continue until the battery time remaining has decreased to 5 minutes. The time remaining number is updated every 30 seconds. (If conditions change, the time remaining number may be inaccurate for a few minutes as the control system makes its calculations.)

When very light loads are supported, or when multiple battery banks are connected, the display message may show a limited projection indicated by “>60” (or a smaller number, based on load). As more data is gathered by the processing system, the estimate may be revised and more time added, to a maximum of “>99”. In extreme cases of small loads on multiple battery banks, the display will stay at “>99” until the battery discharges below 99 minutes.

7. When the UPS reaches the Low Battery Warning Time, the audible alarm will sound again.

3.9.2 Operator Response

1. Press Alarm Silence pad to cancel the audible alarm. (It will sound again at the Low Battery Warning Time.)
2. Verify a power failure has occurred. In addition to indicators and alarms on the UPS, there should be other indications, such as the room lights being off.
3. While the battery is supporting the load, you may reduce the load to extend the battery time. (Remember that the calculations for battery time remaining may take a few minutes.)



NOTE

Determine time required to perform an orderly shutdown of the critical load. Begin shutdown so it will be completed while the battery is still supporting the load.

When battery time remaining has decreased to 5 minutes, reducing the load will not extend battery time.

3.9.3 As Battery Time Approaches Zero

1. If input power is restored while the UPS battery is supporting the load, the UPS will automatically begin conditioning input power. This conditioned power supports the load as it simultaneously recharges the battery.
2. If equipment supported by the UPS is drawing power from the battery as time approaches zero, the UPS continues to supply power to that load until the battery reaches a pre-set voltage level (zero time). To protect the battery from damage, the UPS then shuts itself off and no longer supplies power to the load.
3. If the control system shuts down the UPS at zero time and Auto Restart is **disabled**, the UPS remains off even when input power is restored. To restore power to the load, turn Rotary Switch counterclockwise to Position 1. **The critical bus will be energized as soon as the Rotary Switch is in Position 3.** Perform start-up (**3.6 - Start-Up**) from Position 1. Manually reset and close the battery circuit breaker(s), when supplied, to reconnect the battery.



CAUTION

Turning the Rotary Switch counterclockwise from Position 4 to Position 3 will energize the critical bus. Make sure critical load equipment is ready for power before turning Rotary Switch.



CAUTION

Recharge batteries as soon as possible after discharge. Batteries should be recharged within 24 hours to avoid sulphation and to preserve battery life.

4. If the control system shuts down the UPS at zero time and Auto Restart is **enabled**, the UPS will restart the load 10 seconds after input power is restored (refer to **3.5.2 - System Configuration**). Manually reset and close the battery circuit breaker(s), when supplied, to reconnect the battery.

3.10 Response to a UPS Failure

3.10.1 UPS Response

1. The Static Transfer Switch instantly transfers the load to the Static Bypass Line without interruption of power.
2. An audible alarm will sound.
3. The following message will appear:



4. An Advisory Display LED may illuminate, prompting movement of the rotary switch.

3.10.2 Operator Response

1. Press Alarm Silence pad to cancel the audible alarm.
2. Press the Down pad to view the Alarm Messages screen.
3. Turn Rotary Switch clockwise or counterclockwise in response to the Advisory Display. Continue turning Rotary Switch to Position 1, which de-energizes the UPS while maintaining the critical load through the Maintenance Bypass Line.



CAUTION

Do not turn Rotary Switch to position 0. Doing so will cause an immediate loss of power to the load.

4. Call Liebert Customer Service and Support at **1-800-543-2378**.

3.11 Alarm Messages

When the default screen instructs you to Check Messages, press the Down pad to see the Alarm Messages screen. Active Alarm Messages will be displayed along with a sequence number and time of occurrence. Note that two or more Alarm Messages can have the same sequence number which means they occurred simultaneously. Continue pressing the Down pad until all active Alarm Messages have been displayed.

Table 8 shows Alarm Messages (with related alarms grouped together) and operator corrective action, if any. Contact Liebert Customer Service and Support at **1-800-543-2378** if you require assistance.

Table 8 Alarm Messages

Alarm Message	Meaning and Corrective Action in Brackets []
AC INPUT	
Input power out of tolerance	Frequency or voltage of the input power is outside the acceptable range. The battery supplies power to the critical load through the UPS Module.
DC BUS	
Charger in reduced current mode	Customer has selected reduced current operation of the charger from a contact external to the UPS.
Battery charger problems	The battery is not being charged. The voltage produced by the charger is insufficient to maintain a charge on the battery. [Contact Liebert Customer Service and Support at 1-800-543-2378.]
Low battery warning issued	Battery has been discharging and the Low Battery Warning Time (factory set at 5 minutes, adjustable range 1 to 99 minutes) has been reached. Note time stamp on alarm message. [Follow appropriate procedures to shut down the critical load in an orderly sequence.]
Low battery shutdown	Battery has discharged to the minimum allowable voltage and the UPS is shut down. No power is being supplied to the critical load. [When input power becomes available, perform a UPS start-up procedure.]
DC bus overvoltage	DC bus voltage has exceeded the specified limit and the charger has been turned off. The charger will automatically restart when the DC bus voltage returns to within tolerance. [Contact Liebert Customer Service and Support at 1-800-543-2378 if this condition persists for more than 2 minutes.]
BYPASS	
Bypass frequency out of tolerance	Input power frequency is outside of the specified tolerance (adjustable range .5 to 5 Hz). Automatic transfers to the Static Bypass Line are prohibited. [Do not operate the Rotary Switch while this condition is present.]
Load transferred to bypass due to overload	Critical load connected to the UPS has exceeded the UPS power rating. The load has been automatically transferred to the Static Bypass Line. Power to the load is not being conditioned by the UPS. An automatic retransfer will be attempted when the load is reduced. [Determine cause of the overload and reduce the load.]
Load transferred to bypass due to DC overvoltage	DC bus voltage has exceeded the specified limit. The load has been automatically transferred to the Static Bypass Line. An automatic retransfer will be attempted when the DC bus voltage returns to within tolerance. [Contact Liebert Customer Service and Support at 1-800-543-2378 if this condition persists for more than 2 minutes.]
Excessive retransfers attempted	Several automatic retransfer attempts (15 attempts during 20 minutes or less) have been made to retransfer the load from the Static Bypass Line back to the UPS. The UPS has not been able to consistently sustain the load because of an overload condition or an inverter failure. The load will remain on the Static Bypass Line. Power to the load is not being conditioned by the UPS. [Check other messages for inverter failure. Determine cause of the overload and reduce the load.]
Static Switch failure	A fault has been detected in the Static Transfer Switch. Automatic transfers to the Static Bypass Line are prohibited. [Contact Liebert Customer Service and Support at 1-800-543-2378.]

Table 8 Alarm Messages (continued)

Alarm Message	Meaning and Corrective Action in Brackets []
UPS SYSTEM	
UPS output not synchronized to input power	UPS inverter output is not synchronized with the input power. Automatic transfers to the Static Bypass Line are prohibited. This is usually a temporary condition that is corrected automatically by the UPS internal control system.
Input power single phased	This message indicates an input power problem. [Check all input power phases.]
Input voltage sensor failed	Each input voltage phase has two sensors. One of these sensors has failed. [Contact Liebert Customer Service and Support at 1-800-543-2378.]
Inverter leg over current in X-phase	A fault has been detected in the inverter, caused by a UPS failure. The load has been automatically transferred to the Static Bypass Line. Power to the load is not being conditioned by the UPS. [Contact Liebert Customer Service and Support at 1-800-543-2378.]
Output undervoltage	UPS output voltage is below a specified minimum. The load has been automatically transferred to the Static Bypass Line. Power to the load is not being conditioned by the UPS. An automatic retransfer will be attempted when the output voltage is within tolerance. [Contact Liebert Customer Service and Support if this condition persists.]
Output overvoltage	UPS output voltage is above a specified maximum. The load has been automatically transferred to the Static Bypass Line. Power to the load is not being conditioned by the UPS. An automatic retransfer will be attempted when the output voltage is within tolerance. [Contact Liebert Customer Service and Support if this condition persists.]
Output overcurrent	An output overcurrent surge has been detected. The load has been automatically transferred to the Static Bypass Line. An automatic retransfer will be attempted when the output current returns to nominal. [Contact Liebert Customer Service and Support if this condition persists.]
System output overloaded	An overload condition is present. If the load is on the UPS inverter, the load will be automatically transferred to the Static Bypass Line if the overload exceeds the UPS Module capacity. [Determine cause of the overload and reduce the load.]
Load transferred to bypass due to overload	The load has been automatically transferred to the Static Bypass Line because of an overload condition. [Determine cause of the overload and reduce the load.]
System output overloaded	The overload condition is still present and must be reduced or it will soon exceed the capacity of the Static Bypass Line, resulting in loss of all power to the critical load. Power to the load is not being conditioned by the UPS. [Determine cause of the overload and reduce the load.]
System shutdown due to overload	An overload condition has exceeded the capacity of the Static Bypass Line. The UPS has been shut down, resulting in loss of power to the critical load. [Perform a UPS shutdown procedure. Correct the overload condition and perform a UPS start-up procedure.]
Control error	Automatic diagnostic testing has detected a failure (of hardware or software) in the UPS internal control system. A second message may indicate internal test or software timeout. The load has been automatically transferred to the Static Bypass Line. Power to the load is not being conditioned by the UPS. [Contact Liebert Customer Service and Support at 1-800-543-2378.]
Critical power supply failure	A failure has been detected in one of the low voltage power supplies. The load has been automatically transferred to the Static Bypass Line. Power to the load is not being conditioned by the UPS. [Contact Liebert Customer Service and Support at 1-800-543-2378.]
Load transferred due to internal protection	A failure has been detected in the UPS. More specific information may be available in a separate Alarm Message. The load has been automatically transferred to the Static Bypass Line (provided the power available on the bypass line is within specifications). Power to the load is not being conditioned by the UPS. [Contact Liebert Customer Service and Support at 1-800-543-2378.]

Table 8 Alarm Messages (continued)

Alarm Message	Meaning and Corrective Action in Brackets []
UPS SYSTEM (continued)	
External shutdown	The UPS has been shut down from an external contact. [Perform a UPS start-up procedure when the conditions causing the external shutdown have been corrected.]
COOLING	
Fan failure	A failure has been detected in at least one of the internal cooling fans. [Contact Liebert Customer Service and Support at 1-800-543-2378.]
System shutdown impending due to over-temperature	An over-temperature condition is present in the UPS cabinet. The UPS will automatically shutdown if the over-temperature continues. [Determine the cause of the condition and correct it if possible. Check for clogged air filter, restricted air flow, or fan failure.]
System shutdown in 5 minutes due to over-temp	Over-temperature condition has persisted. Note the time stamp on the alarm message. [Perform an orderly shutdown of the critical load. Perform a UPS shutdown procedure or allow the UPS to perform an automatic shutdown. Contact Liebert Customer Service and Support at 1-800-543-2378.]

4.0 MAINTENANCE

4.1 Safety Precautions

Read this section thoroughly, paying special attention to the sub-sections that apply to you, before working with the UPS. Also read the battery manufacturer's manual before working on or near the battery.

Under typical operation and with all UPS doors closed, only normal safety precautions are necessary. The area around the UPS system and battery should be kept free from puddles of water, excess moisture, or debris.

Special safety precautions are required for procedures involving handling, installation, and maintenance of the UPS system or the battery. Observe precautions in **2.0 - Installation** before handling or installing the UPS system. Observe precautions in this section before as well as during performance of all maintenance procedures. Observe all battery safety precautions before working on or near the battery.

This equipment contains several circuits that are energized with high voltage. Only test equipment designated for troubleshooting should be used. This is particularly true for oscilloscopes. Always check with an AC and DC voltmeter to ensure safety before making contact or using tools. Even when the power is turned Off, dangerously high potentials may exist at the capacitor banks. Observe all battery precautions when near the battery for any reason.

ONLY qualified service personnel should perform maintenance on the UPS system. When performing maintenance with any part of the equipment under power, service personnel and test equipment should be standing on rubber mats. The service personnel should wear insulating shoes for isolation from direct contact with the floor (earth ground).

Unless power is removed from the equipment, one person should never work alone. A second person should be standing by to assist and summon help in case an accident should occur. This is particularly true when work is performed on the battery.

A **Warning** is used to signal the presence of a possible serious, life-threatening condition. For example:



WARNING

LETHAL VOLTAGES MAY BE PRESENT WITHIN THIS UNIT EVEN WHEN IT IS APPARENTLY NOT OPERATING. OBSERVE ALL CAUTIONS AND WARNINGS IN THIS MANUAL. FAILURE TO DO SO COULD RESULT IN SERIOUS INJURY OR DEATH. DO NOT WORK ON OR OPERATE THIS EQUIPMENT UNLESS YOU ARE FULLY QUALIFIED TO DO SO!! NEVER WORK ALONE.

A **Caution** symbol indicates a condition that could seriously damage equipment and possibly injure personnel. For example:



CAUTION

Start-up must be performed exactly as instructed. Follow prompts on the Advisory Display. Turning the Rotary Switch too soon or in the wrong sequence may result in immediate loss of power to the critical load.

A **Note** symbol is used to emphasize important text. If the note is not followed, equipment could be damaged or may not operate properly. For example:



NOTE

Determine time required to perform an orderly shutdown of the critical load. Begin shutdown so it will be completed while the battery is still supporting the load.

4.2 When To Call

Call for service if you encounter any of the following conditions:

1. Repeated start-up attempts are unsuccessful.
2. A UPS fault occurs which will not clear.
3. The Battery Status message indicates a discharging battery although the input power, rather than the battery, is supporting the load.
4. The normal operation of the critical load repeatedly causes an overload condition. Although this is not a UPS fault, a qualified person should analyze the total load connected to the UPS.
5. Any indicators or alarms operate improperly.
6. Any other abnormal function of the system occurs.

4.3 Steps To Take

If any of the above occur:

1. Follow instructions appearing in the alarm message, or in the explanation corresponding to the message (**3.11 - Alarm Messages**). If the screen message indicates the load is being supported by the battery, refer to **3.9 - Response to a Power Failure**.
2. Call Liebert Customer Service and Support at **1-800-543-2378**.



WARNING

**LETHAL VOLTAGES ARE PRESENT INSIDE THE EQUIPMENT
EVEN WHEN THE ROTARY SWITCH IS IN THE OFF POSITION.
REFER SERVICE TO QUALIFIED PERSONNEL ONLY.**

4.4 Preventive Maintenance

Series 300 UPS Operator maintenance consists of basic tasks listed in this section. Other maintenance requires Liebert Service personnel.

4.4.1 Maintaining an Operator's Log

Careful record keeping will ensure appropriate maintenance of the UPS and facilitate correction of any abnormal condition. Periodically check system status readings and compare them to normal readings for your Series 300 UPS model. Refer to **6.0 - Specifications**.

The operator's log should contain the following information:

- Dates of air filter replacement.
- Dates that battery maintenance was performed.
- Dates that input, output, and battery status readings were checked, and the values of those readings.
- The verbatim recording of any message associated with an abnormal condition. Initial messages may be replaced with additional messages. If it is necessary to call Liebert Service, a written record of all message information should be available.

4.4.2 Changing the Air Filter

An air filter is included in the Series 300. **Check the air filter periodically (at least once every six months) and replace it as necessary.**

1. Open the UPS cabinet door and locate the air filter at the bottom of the UPS module cabinet.
2. Slide the filter out of the cabinet toward you. Based on visual examination, determine if the filter should be replaced.
3. Return the same air filter to its correct position or replace with a new air filter.

4.4.3 Periodic Restart of the UPS

Once or twice a year, it is advisable to power down the UPS to the Maintenance Bypass Line, then perform start-up. The start-up procedure includes self-diagnostic testing of the UPS which may reveal conditions that require attention.

1. Turn the rotary switch counterclockwise to Position 1 (not Position 0), thereby transferring the critical load to the Maintenance Bypass Line.
2. Perform start-up according to **3.6 - Start-Up**.
3. Record, verbatim, any messages displayed during start-up.
4. Follow instructions contained in screen messages.

4.4.4 Maintaining the Battery



WARNING

THESE MAINTENANCE PROCEDURES WILL EXPOSE HAZARDOUS LIVE PARTS. REFER SERVICING TO QUALIFIED PERSONNEL.

BATTERY DC FUSES OPERATE AT THE RATED BATTERY VOLTAGE AT ALL TIMES. A BLOWN DC BUS FUSE INDICATES A SERIOUS PROBLEM. SERIOUS INJURY OR DAMAGE TO THE EQUIPMENT CAN RESULT IF THE FUSE IS REPLACED WITHOUT KNOWING WHY IT FAILED. CALL LIEBERT CUSTOMER SERVICE AND SUPPORT FOR ASSISTANCE.

Battery Safety Precautions

Servicing of batteries should be performed or supervised by personnel knowledgeable of batteries and the required precautions. Keep unauthorized personnel away from batteries.

When replacing batteries, use the same number and type of batteries.



CAUTION

Lead-acid batteries contain hazardous materials. Batteries must be handled, transported, and recycled or discarded in accordance with federal, state, and local regulations. Because lead is a toxic substance, lead-acid batteries should be recycled rather than discarded.

Do not dispose of battery or batteries in a fire. The battery may explode.

Do not open or mutilate the battery or batteries. Released electrolyte is harmful to the skin and eyes. It may be toxic.

A battery can present a risk of electrical shock and high short circuit current. The following precautions should be observed when working on batteries:

- 1. Remove watches, rings, or other metal objects.**
- 2. Use tools with insulated handles.**
- 3. Wear rubber gloves and boots.**
- 4. Do not lay tools or metal parts on top of batteries.**
- 5. Disconnect charging source prior to connecting or disconnecting battery terminals.**
- 6. Determine if battery is inadvertently grounded. If inadvertently grounded, remove source of ground. Contact with any part of a grounded battery can result in electrical shock. The likelihood of such shock will be reduced if such grounds are removed during installation and maintenance.**

Lead-acid batteries can present a risk of fire because they generate hydrogen gas. The following procedures should be followed:

- 1. DO NOT SMOKE when near batteries.**
- 2. DO NOT cause flame or spark in battery area.**
- 3. Discharge static electricity from body before touching batteries by first touching a grounded metal surface.**

Battery Safety Precautions in French Per CSA Requirements

Instructions Importantes Concernant La Sécurité

Conserver Ces Instructions



ADVERTISSEMENT

DES PIÈCES SOUS ALIMENTATION SERONT LAISSÉES SANS PROTECTION DURANT CES PROCÉDURES D'ENTRETIEN. UN PERSONNEL QUALIFIÉ EST REQUIS POUR EFFECTUER CES TRAVAUX.

LES FUSIBLES A C.C. DE LA BATTERIE D'ACCUMULATEURS OPÈRENT EN TOUT TEMPS A LA TENSION NOMINALE. LA PRÉSENCE D'UN FUSIBLE A C.C. BRÛLE INDIQUE UN PROBLÈME SÉRIEUX. LE REMPLACEMENT DE CE FUSIBLE, SANS AVOIR DÉTERMINÉ LES RAISONS DE LA DÉFECTUOSITÉ, PEUT ENTRAÎNER DES BLESSURES OU DES DOMMAGES SÉRIEUX A L'ÉQUIPEMENT. POUR ASSISTANCE, APPELER LE DÉPARTEMENT DE SERVICE A LA CLIENTÈLE DE LIEBERT.



DANGER

Les accumulateurs plomb-acide contiennent de la matière comportant un certain risque. Les accumulateurs doivent être manipulés, transportés et recyclés ou éliminés en accord avec les lois fédérales, provinciales et locales. Parce que le plomb est une substance toxique, les accumulateurs plomb-acide devraient être recyclés plutôt qu'éliminés.

Il ne faut pas brûler le ou les accumulateurs. L'accumulateur pourrait alors exploser.

Il ne faut pas ouvrir ou endommager le ou les accumulateurs. L'électrolyte qui pourrait s'en échapper est dommageable pour la peau et les yeux. Un accumulateur représente un risque de choc électrique et de haut courant de court-circuit. Lorsque des accumulateurs sont manipulés, les mesures préventives suivantes devraient être observées:

1. Retirer toutes montres, bagues ou autres objets métalliques.
2. Utiliser des outils avec manchon isolé.
3. Porter des gants et des bottes de caoutchouc.
4. Ne pas déposer les outils ou les pièces métalliques sur le dessus des accumulateurs.
5. Interrompre la source de charge avant de raccorder ou de débrancher les bornes de la batterie d'accumulateurs.
6. Déterminer si l'accumulateur est mis à la terre par erreur. Si oui, défaire cette mise à la terre. Tout contact avec un accumulateur mis à la terre peut se traduire en un choc électrique. La possibilité de tels chocs sera réduite si de telles mises à la terre sont débranchées pour la durée de l'installation ou de l'entretien.

Les accumulateurs plomb-acide présentent un risque d'incendie parce qu'ils génèrent des gaz à l'hydrogène. Les procédures suivantes devront être respectées.

1. **NE PAS FUMER** lorsque près des accumulateurs.
2. **NE PAS** produire de flammes ou d'étincelles près des accumulateurs.
3. Décharger toute électricité statique présente sur votre corps avant de toucher un accumulateur en touchant d'abord une surface métallique mise à la terre.



DANGER

L'électrolyte est un acide sulfurique dilué qui est dangereux au contact de la peau et des yeux. Ce produit est corrosif et aussi conducteur électrique. Les procédures suivantes devront être observées:

1. Porter toujours des vêtements protecteurs ainsi que des lunettes de protection pour les yeux.
2. Si l'électrolyte entre en contact avec la peau, nettoyer immédiatement en rinçant avec de l'eau.
3. Si l'électrolyte entre en contact avec les yeux, arroser immédiatement et généreusement avec de l'eau. Demander pour de l'aide médicale.
4. Lorsque l'électrolyte est renversée, la surface affectée devrait être nettoyée en utilisant un agent neutralisant adéquat. Une pratique courante est d'utiliser un mélange d'approximativement une livre (500 grammes) de bicarbonate de soude dans approximativement un gallon (4 litres) d'eau. Le mélange de bicarbonate de soude devra être ajouté jusqu'à ce qu'il n'y ait plus apparence de réaction (mousse). Le liquide résiduel devra être nettoyé à l'eau et la surface concernée devra être asséchée.

Matching Battery Cabinets

Although the individual battery cells are sealed (valve-regulated) and require only minimal maintenance, the Battery Cabinets should be given a periodic inspection and electrical check. Checks should be performed at least annually to ensure years of trouble-free service. Tightness of battery terminal connections should be compared to recommended retorquer value. Battery service agreements are available through Liebert Customer Service and Support.

Voltage Records. With the Battery Cabinet DC disconnect closed and the connected UPS operating, measure and record battery float voltage. With the DC disconnect open, measure and record the nominal (open circuit) voltage. Both these measurements should be made across the final positive and negative terminal lugs. Compare these values with those shown below. The recorded nominal voltage should be no less than the value shown, while the recorded float voltage should be within the range shown. If a discrepancy is found, contact Liebert Customer Service and Support at **1-800-543-2378**.

Number of Cells	Battery Voltage (VDC)	
	Nominal	Float
102	204	230 - 232
180	360	405 - 409

Power Connections. Check for corrosion and connection integrity. Visually inspect wiring for discolored or cracked insulation. Clean and/or retighten as required. Refer to torque specifications in **Table 6**.

Battery Cell Terminals. Check for discoloration, corrosion, and connection integrity. Clean and tighten if necessary. Note that when installing a new battery, the initial torque value is more than the retorquer value. Torque values are:

Battery Model Number	Initial Torque Value	Retorque Value
UPS12-100(FR) UPS12-140(FR) UPS12-170(FR) UPS12-270(FR)	40 lb-in.	32 lb-in.
UPS12-310(FR) UPS12-370(FR)	65 lb-in.	52 lb-in.
UPS12-475(FR)	110 lb-in.	110 lb-in.

If you have a different model battery, contact Liebert Customer Service and Support at **1-800-543-2378** for the required torque value.

To access battery cell terminals, remove the hardware and top straps located at the lower front of the battery shelf. Disconnect the cables connected to the battery. Once disconnected, insulate (with protective boot or electrical tape) the cables to prevent accidental shorts. The battery can now be pulled forward using the horizontal straps. When replacing the battery, the terminal connections must be cleaned and tightened.

Non-Standard Batteries

If the UPS system uses a battery other than a factory supplied Matching Battery Cabinet, perform maintenance on the battery as recommended in the battery manufacturer's maintenance manual.



CAUTION

The electrolyte is a dilute sulfuric acid that is harmful to the skin and eyes. It is electrically conductive and corrosive. The following procedures should be observed:

1. Wear full eye protection and protective clothing.
2. If electrolyte contacts the skin, wash it off immediately with water.
3. If electrolyte contacts the eyes, flush thoroughly and immediately with water. Seek medical attention.
4. Spilled electrolyte should be washed down with a suitable acid neutralizing agent. A common practice is to use a solution of approximately one pound (500 grams) bicarbonate of soda to approximately one gallon (4 liters) of water. The bicarbonate of soda solution should be added until the evidence of reaction (foaming) has ceased. The resulting liquid should be flushed with water and the area dried.

Battery Cabinet Voltage Record			
Date	Float Voltage (Volts DC)	Nominal Voltage (Volts DC)	Ambient Temp. (°F)
* _____	* _____	* _____	* _____
_____	_____	_____	_____
_____	_____	_____	_____
_____	_____	_____	_____
_____	_____	_____	_____
_____	_____	_____	_____
_____	_____	_____	_____
_____	_____	_____	_____
_____	_____	_____	_____
_____	_____	_____	_____
_____	_____	_____	_____
_____	_____	_____	_____
_____	_____	_____	_____
_____	_____	_____	_____
_____	_____	_____	_____

* To be completed by Liebert Customer Service Representative at time of start-up.

4.5 Liebert Customer Service and Support

Start-up, UPS maintenance, battery maintenance, and training programs are available for the Series 300 UPS through your Liebert sales representative.

Professional Start-up

UPS Start-Up. Liebert's Customer Engineers perform a thorough non-powered inspection of the units, and will then conduct a complete electrical checkout which includes calibrating all components to published specifications. The battery installation is also inspected and placed on an initialization charge to ensure cell equalization. Customer-Operation training will be conducted during battery charge time.

Load Bank Testing and Full Site Acceptance Testing are additional services that can be performed during a UPS Start-Up. One Preventive Maintenance Service Call can be added to the initial UPS Start-Up Agreement.

Battery Installation/Start-Up. When purchased with a UPS Start-Up, this Agreement provides consistent, professional service for your entire UPS system. This one-source approach avoids conflicts that may occur during a multi-source installation. Note that Liebert requires a mandatory installation inspection for all batteries not installed by Liebert Customer Engineers.

Battery IEEE Certification Inspection. The Battery Specialist will perform a detailed inspection of the entire battery system to ensure it meets current IEEE standards.

Maintenance Agreements

UPS Standard Full Service Agreement. This Agreement offers a total service package for UPS systems. This includes two scheduled Preventive Maintenance (P.M.) Service Calls per year. It also covers all Remedial and Corrective Maintenance visits, consisting of the diagnosis and correction of product malfunctions and repairs, and parts. Customer Engineers will be available to the Customer 24 hours a day, 7 days a week.

This agreement also includes one Infra-Red Scanning visit. A full Thermographic Survey is offered as an additional service.

UPS Preventive Maintenance Service. One Preventive Maintenance (P.M.) Service Call will be scheduled and performed at the customer's convenience. During a P.M. visit, the Customer Engineer will conduct a thorough non-powered inspection. Then, the powered inspection will include a complete electrical checkout and calibration of all components to specifications.

Battery Basic Service Agreement. This Agreement provides two (for sealed cells) or four (for flooded cells) visits per year. During these visits, the entire battery system will be inspected and checked against factory specifications. The Battery Specialist will clean, add water, adjust voltages, and tighten connections as needed. A report of all recordings taken during each visit (voltages, specific gravity, etc.) will be prepared for the Customer. Any recommendations for corrective action, such as cell replacements, will be noted.

Battery Standard Full Service Agreement. This Agreement includes four P.M. visits per year and corrective maintenance.

Extended Full Service Agreements. For the UPS system and for the battery, these Agreements provide the Customer the convenience of scheduling P.M. visits during evenings and weekends. The Battery Extended Full Service Agreement provides four (for sealed cells) or twelve (for flooded cells) P.M. visits per year, corrective maintenance, and parts.

Training

Customer training courses include the proper operation of the system, emergency procedures, preventive maintenance, and some corrective maintenance.

Warranties

Contact Customer Service and Support at **1-800-543-2378** if you have any questions regarding the warranty on your Series 300 UPS or the batteries.

5.0 SYSTEM OPTIONS

5.1 General

This section describes options available with the Series 300 UPS including the user wiring requirements. The options described are:

- External Maintenance Bypass
- Slim-Line Distribution
- Remote Status Panel
- Remote Contact Board
- RS-232 Interface Port
- SNMP
- Modem
- SiteScan[®]/Sitemaster Interface
- IBM[®] AS/400 Signal Interface
- System/38 Power Warning Signal
- Battery Circuit Breaker
- Contact Isolator Board
- DC Ground Fault Alarm
- Computer Interface System
- Multi-Computer Interface System
- IBM[®] AS/400 Multi-Computer Interface System

5.2 Optional External Maintenance Bypass Cabinet

The external maintenance bypass cabinet is a matching cabinet extension which is field installed on the right side of the UPS module. This cabinet includes a rotary switch to provide a single control for transferring to and from maintenance bypass. Input and output circuit breakers and a shielded bypass isolation transformer are included in specific configurations. This cabinet adds 22 inches or 36 inches to the right side of the UPS module depending on which configuration is chosen. Refer to **Figure 2** and **Figure 22** or **Figure 23**.

- **Cabinet Inspection:** Remove all panels and visually inspect the physical components, internal connections, and cabinet for any damage. If there are signs of damage, do not proceed. Call Liebert Customer Service and Support at **1-800-542-2378**.

5.2.1 Installation

Location Considerations:

The external maintenance bypass cabinet must be bolted to the right side of the UPS module. It cannot be installed separately from the UPS module.

- **Barrier Panel:** The barrier panel must be installed utilizing the panel and hardware which is supplied with the maintenance bypass cabinet.



CAUTION

A barrier panel must be placed between the external maintenance bypass cabinet and the UPS module.

- **Service Clearance:** Allow front access to the external maintenance bypass cabinet at all times for maintenance and servicing. Electrical codes require that the maintenance bypass cabinet be installed with no less than 3 feet at the front of the cabinet. Side and rear panels do not require service clearance.

Electrical Wiring:



WARNING

ALL POWER CONNECTIONS MUST BE COMPLETED BY A LICENSED ELECTRICIAN THAT IS EXPERIENCED IN WIRING THIS TYPE OF EQUIPMENT. WIRING MUST BE INSTALLED IN ACCORDANCE WITH ALL APPLICABLE NATIONAL AND LOCAL ELECTRICAL CODES. IMPROPER WIRING MAY CAUSE DAMAGE TO THE EQUIPMENT OR INJURY TO PERSONNEL. VERIFY THAT ALL INCOMING HIGH AND LOW VOLTAGE POWER CIRCUITS ARE DE-ENERGIZED AND LOCKED OUT BEFORE INSTALLING CABLES OR MAKING ANY ELECTRICAL CONNECTIONS.

Refer to **Table 2 - Site Planning Data, Series 300 UPS, 10 to 50 kVA** and **Table 3 - Site Planning Data, Series 300 UPS, 65 to 125 kVA** and installation drawings (**Figure 1 through Figure 11, and Figure 22 or Figure 23**).



NOTE

Refer to 2.4.1 - UPS Wire Size Guidelines.

- **Wiring Connections:** Verify the following connections have been made in addition to the wiring connections outlined in **2.4.4 - Wiring Connections**.
 - a. AC power cables from input power source to external maintenance bypass cabinets. (Observe A-B-C rotation.)

An input neutral is not required if the UPS module and the external maintenance bypass cabinet are both equipped with an isolation transformer.

If the UPS module and the external maintenance bypass cabinet are provided without isolation transformers and there are line-to-neutral loads connected to the UPS output, the input source must be wye connected and have three-phase plus neutral plus ground.
 - b. AC power cables labeled “Input” from the external maintenance bypass to the UPS module AC input are supplied by Liebert. These cables must be routed from the external maintenance bypass cabinet through the barrier panel on the UPS module. (Observe A-B-C rotation.)
 - c. AC power cables labeled “Output” from the external maintenance bypass cabinet to the UPS module AC output are supplied by Liebert. These cables must be routed from the external maintenance bypass cabinet through the barrier panel on the UPS module. (Observe A-B-C rotation.)
 - d. AC power cables from the maintenance bypass cabinet output to the critical load distribution or Slim-Line Distribution. (Observe A-B-C rotation.)
- **Wiring Inspection:**
 - a. Verify all power connections are tight.
 - b. Verify all control wire terminations are tight.
 - c. Verify all power wires and connections have proper spacing between exposed surfaces, phase-to-phase and phase-to-ground.
 - d. Verify that all control wires are run in individual, separate steel conduit.

5.2.2 Operation

Control (Rotary Switch)

The operator control switch for the Series 300 external maintenance bypass can be accessed by opening the cabinet front door.



NOTE

The single control simplifies the operation of the external maintenance bypass. However, read these instructions carefully before operating the Rotary Switch. Improper positioning of the Rotary Switch could result in unwanted actions.

Figure 18 External Maintenance Bypass Rotary Switch

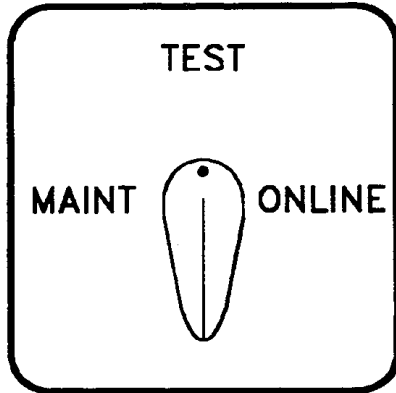

The three Rotary Switch positions are:

1. **Maintenance:** connects power to the critical load through the external maintenance bypass line. UPS module is de-energized for maintenance purposes.
2. **Test:** connects power to the input of the UPS module, while the load is still supplied through the external Maintenance Bypass Line. At this point operational checks can be accomplished on the UPS module while the load is powered by the external maintenance bypass.
3. **On-Line:** connects the critical load to the output of the UPS module and establishes normal operation.

Start-up from “Maintenance” Position (External Maintenance Bypass Cabinet)

Initial start-up must be performed by Liebert service personnel. Start-up procedures described in this manual refer to start-up of the UPS after a shutdown for maintenance or after an abnormal condition has been corrected.



CAUTION

Start-up must be performed exactly as instructed. Turning the rotary switch too soon or in the wrong sequence may result in immediate loss of power to the critical load.

Figure 19 Block Diagram of the External Maintenance Bypass

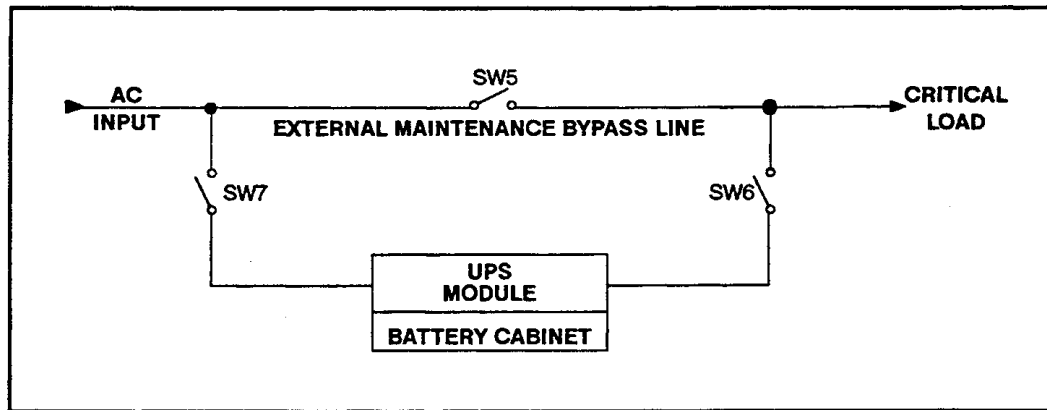

NOTE: Your unit may include the following optional components: Input CB, Isolation Transformer, and Output (Load) CB.

ROTARY SWITCH POSITION	SW5	SW6	SW7
MAINTENANCE	Closed	Open	Open
TEST	Closed	Open	Closed
ON-LINE	Open	Closed	Closed

1. Verify the UPS module rotary switch is in position 0 or position 1, and external maintenance bypass cabinet rotary switch is in “Maintenance” position.
2. Close circuit breaker or switch to apply power to external maintenance bypass cabinet from user’s supply source (not part of the UPS).
3. (if applicable) Close optional input circuit breaker on the external maintenance bypass cabinet.
4. (if applicable) Close optional output circuit breaker on the external maintenance bypass cabinet.
5. Turn the rotary switch on external maintenance bypass cabinet to “Test” position.
6. Turn the rotary switch on UPS module to position 1 “On Bypass” (refer to **3.6.1 - Start-Up Procedure** for details).
7. Turn the rotary switch on UPS module to position 2 “UPS Start” and follow instructions on the UPS Advisory Display (refer to **3.6.1 - Start-Up Procedure** for details).
8. Turn the rotary switch on the UPS module to position 3 “UPS Check” and follow instructions on the UPS Advisory Display (refer to **3.6.1 - Start-Up Procedure** for details).
9. Turn the rotary switch on the external maintenance bypass cabinet to the “On-Line” position.
10. Turn the rotary switch on the UPS module to position 4 “On UPS” and follow instructions on the UPS Advisory Display (refer to **3.6.1 - Start-Up Procedure** for details).

Start-up is now complete. No further actions are required of the operator unless an abnormal condition occurs.

Shutdown to “Maintenance” Position

To remove the UPS module from service for maintenance or other reasons while providing power to the critical load through the external maintenance bypass line, perform the following steps.

1. Turn the rotary switch on the UPS module counterclockwise from position 4 to position 3 and observe the instructions on the UPS Advisory Display (refer to **3.8.1 - Shutdown to Maintenance Bypass** for details).
2. Turn the rotary switch on the UPS Modules counterclockwise from position 3 to position 2 to position 1. Do not turn the rotary switch to Position 0 at this time. Doing so would cause an immediate loss of power to the load. There is no power to the UPS module control system in this position. Therefore the digital display will be blank.
3. Turn the Rotary Switch on the external maintenance bypass cabinet to the “Test” position and then to the “Maintenance” position.
4. Turn the rotary switch on the UPS module counterclockwise from position 1 to position 0. At this point the UPS module will be electrically de-energized.

Complete Shutdown

5. (if applicable) Open optional output circuit breaker on the external maintenance bypass cabinet.
6. (if applicable) Open optional input circuit breaker on the external maintenance bypass cabinet.
7. Open the circuit breaker or switch that supplies power to the external maintenance bypass cabinet (not part of the UPS system).

5.3 Optional Slim-Line Distribution

The Slim-Line Distribution is a cabinet extension, on the right side of the UPS module, to enclose one or two 42-pole panelboards. A main circuit breaker is provided with each panelboard. This option is designed for field installation on the right side of the UPS module, and adds ten (10) inches to the cabinet width. Power wiring between the UPS output and the Slim-Line panelboard is provided by the installing contractor. Branch circuit breakers and output distribution cables (bottom entry) are field installed by others. Access clearance of three (3) feet is required on the right side of the cabinet. For installation and wiring details refer to **Figure 24**.

5.4 Optional Remote Status Panel

The Remote Status Panel includes:

- Load on UPS Indicator (Green LED)
- Battery Discharge Alarm (Red LED)
- Low Battery Reserve Alarm (Red LED)
- Load on Bypass Alarm (Red LED)
- UPS Alarm Condition (Red LED)
- New Alarm Condition (Red LED)
- Audible Alarm
- Lamp Test/Reset Pushbutton
- Audio Reset Pushbutton

The panel is provided in a NEMA Type 1 enclosure suitable for wall mounting. Interface of the panel to the UPS is through connection of control wiring between terminal strips in the UPS cabinet and remote status panel. Refer to **Figure 8**, **Figure 9**, or **Figure 10** and **Figure 25** for wiring details.

5.5 Optional Remote Contact Board

The Remote Contact Board includes individual isolated Form C contacts for: Battery discharging alarm, low battery reserve alarm, load on bypass alarm, summary alarm, and new alarm for a second summary alarm condition. A terminal strip is provided on the optional alarm relay board for user connection to the individual alarm contacts. Refer to **Figure 8**, **Figure 9**, or **Figure 10** and **Figure 26** for wiring details.



NOTE

The alarm relay board is included as part of the remote status panel option kit, and therefore eliminates the need to add the remote contact board option when a remote status panel option is provided.

5.6 Optional RS-232 Interface Port

With this option, all four forms of information present on the UPS display are available to the user in standard ASCII format via a 25-pin D connector. These include status, instrumentation, alarms, and diagnostics. This information (present status) can be transmitted to a dumb terminal on request, by pressing the spacebar at the terminal. Any time an alarm condition occurs, it will automatically be transmitted. The present status will automatically be updated with the occurrence of any alarm. **Note: Use of this option precludes the use of the internal modem, internal SNMP, and SiteScan/Sitemaster interface options.**

5.6.1 Using a Terminal as a Remote Station

If your UPS is not equipped with either a modem or an SNMP adapter, the RS-232-C connection will be free for use with a remote terminal or PC. The cable used to connect the UPS to the terminal should be wired as shown in **Figure 20**.

Be sure your terminal is set to the same communication parameters as the UPS (see **Incoming Calls** in 5.8.2 - **Using the Modem**).

Figure 20 Cable Connections between UPS and Terminal

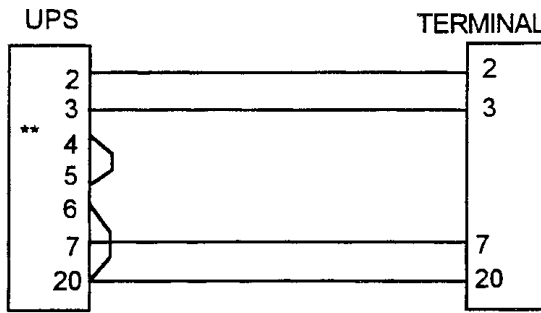

**** NOTE**

Some revisions of this circuit board have incorrectly identified pin numbers. The defective versions can be identified because the white labeling on the board does not agree with the numbers stamped on the connector. If you encounter such a board, use the numbers on the connector, not the numbers on the board.

5.6.2 Remote Front Panel (Terminal Mode)

Whether the connection is made through a modem or directly to a terminal, pressing the <SPACE BAR> will command the UPS to enter Remote Front Panel mode. The UPS will “draw” the following image on the remote terminal (see **Figure 21**).

This screen is the remote front panel. Using the UP, DOWN, and ENTER keys on your keyboard will allow you to examine screens and modify settings just as if you were pressing the buttons on the front panel of the UPS. In addition, the menu bar at the top of the screen provides the following functions (see **Table 9**).

Figure 21 UPS Remote Monitor/Control

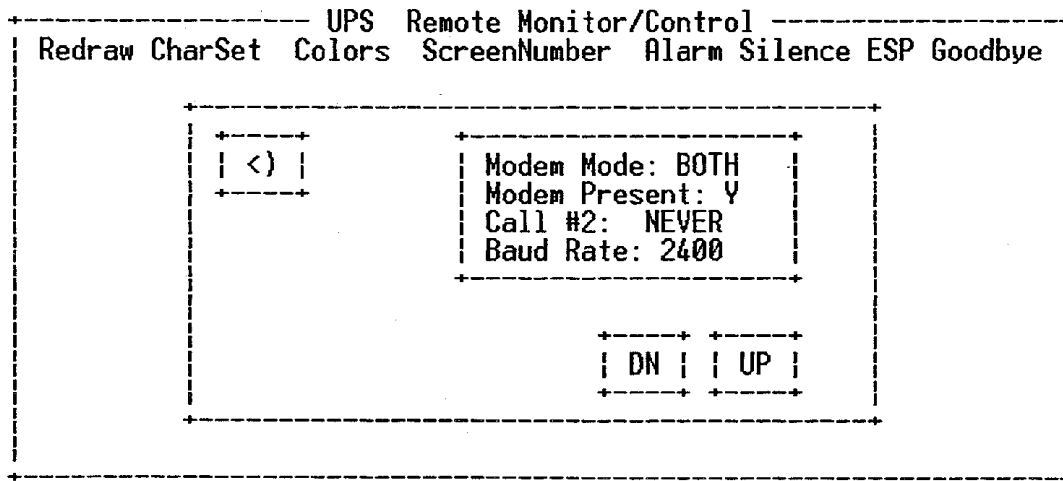

Table 9 Terminal Mode Menu

Item	Key	Description
Redraw	R	Redraws the screen-in case data was corrupted during transmission.
Charset	C	Changes from the ASCII character set to the IBM-PC character set. If your remote terminal is an IBM-PC or compatible, this may produce a more attractive screen.
Colors	O	Redraws the screen with a different color set. There are 4 color sets.
Screen Number	S	Displays the current screen number on the top line of the remote 4 by 16 character LCD display.
Alarm Silence	A	Silences the UPS alarm and the speaker on the terminal.
ESP	E	Switch to Emerson Standard Protocol. Unless you have an application program which communicates using ESP, you will not need to use this option. Should you ever accidentally enter ESP mode, type the word EXIT to return to terminal mode. If you have entered ESP mode, the keyboard will stop responding normally.
Good-bye	G	Use Good-bye to hang up if you are connected over a modem.

There are some operations defined which are normally activated using more than one pushbutton at the same time at the front panel. For example, pressing UP, DOWN, and ALARM SILENCE all together returns the display to English from any other language. Pressing more than one button together is called a chord. Chords can be simulated from a remote keyboard using the following keys:

Pushbutton Chord Map	
Chord	Key
UP + DOWN + ALARM SILENCE	7
UP + DOWN	K
DOWN + ALARM SILENCE	Z

5.6.3 Emerson Standard Protocol (ESP)

ESP is a block oriented binary protocol with error checking designed for computer-to-UPS communication. If you wish to write applications to interface with the UPS directly, ask your customer service representative for a copy of the Series 300 Emerson Standard Protocol documentation.

5.6.4 Remote Load Control

The load can be turned on or off from your remote terminal by accessing the Load Control Screen.



If the load is ON in position 4 you can turn it OFF by changing the “ON” field to “OFF” and pressing ALARM SILENCE. Conversely, if the load is OFF in position 4, change the field to “ON” and press ALARM SILENCE. The load will restart in 5 to 10 seconds.



NOTE

If password protection has been enabled the load field can only be changed when load control is ‘unlocked’ (see 5.6.5 - Setting the Password).



WARNING

THE REMOTE LOAD CONTROL FEATURE OF THE UPS ENABLES DIRECT CONTROL OF THE LOAD FROM ANY TERMINAL OR PC IN THE WORLD IF THE UPS IS EQUIPPED WITH A MODEM AND THE MODEM MODE IS SET TO IN OR BOTH.

IF PASSWORD PROTECTION OF THIS FEATURE IS NOT ENABLED BY THE USER, ANYONE WITH A MODEM CAN CALL IN AND TURN OFF THE LOAD. WE STRONGLY RECOMMEND THAT YOU ENABLE PASSWORD PROTECTION OF YOUR LOAD BY FOLLOWING THE INSTRUCTIONS IN 5.6.5 - SETTING THE PASSWORD.

5.6.5 Setting the Password

The password is used to lock or unlock the remote load control facility. When locked, the remote load control screen will not respond, and the load cannot be turned on or off either locally using the pushbuttons or remotely via a terminal. By default the load control is unlocked. To lock the remote load control screen, edit the password. The password can be from 1 to 6 characters. The default password is “AAAAAA”.

Once the password has been edited, it will appear as six asterisks, and the status field will change from UNLOCKED to LOCKED:

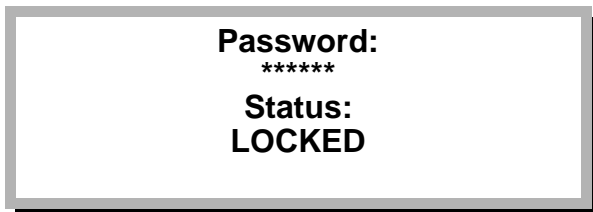

To unlock the load control feature, you must input the password by editing each of the asterisks (*) to the correct letter of the password. When the sixth letter has been entered, press ALARM SILENCE. The password field will return to all asterisks, but the status field will change to UNLOCKED. The load control will remain unlocked for 5 minutes, and then will automatically

relock. During this 5 minute interval, the load control screen will be active and will allow you to turn the load on or off at will.

If you wish to change the password, first unlock the load control by entering the old password. When the status field changes to UNLOCKED, re-edit the password field to the new password. This new password will be automatically and permanently changed when you exit the edit operation. **Note: Be sure to write the password down so it won't be forgotten or lost.**

If you wish to unlock the load control for a prolonged period, edit the password back to the factory default value of "AAAAAA".

5.7 Optional Internal SNMP (Simple Network Management Protocol) Support

With the optional SNMP adapter, the UPS can be directly connected to any I.P. based network using Token Ring or Ethernet media. The UPS will become a managed device on the network. From a network management station the system administrator can monitor important system measurements, alarm status, etc. He can also execute battery tests and observe the results, and turn the load on or off. **Note: Use of this option precludes the use of the RS-232 interface port, internal modem, and SiteScan/Sitemaster interface options.**

5.7.1 Using an SNMP Adapter (Optional)

For instructions on using the Simple Network Management Protocol adapter option, see the documentation supplied separately.

5.8 Optional Internal Modem

The UPS can dial out and notify up to two remote computers, terminals, PCs, or pocket pagers when important events occur. Also, it is now possible to call a modem equipped UPS from a remote terminal, computer, or PC and monitor or control the UPS from this remote station. **Note: Use of this option precludes the use of the RS-232 interface port, internal SNMP, and SiteScan/Sitemaster interface options.**

5.8.1 The Communication Mode Screen

Several screens have been added to support communication options and settings. Understanding the Communication Mode Screen is fundamental to being able to use the new communication facilities:

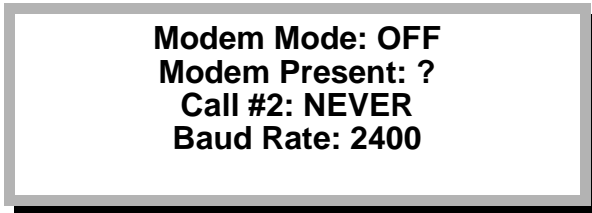

```
Modem Mode: OFF
Modem Present: ?
Call #2: NEVER
Baud Rate: 2400
```

Setting the Modem Mode

The Modem Mode setting can be OFF, IN, OUT, or BOTH. When the Modem Mode is OFF, the modem is not enabled; incoming calls will not be accepted and outgoing calls will not be made. When the mode is set to IN, only incoming calls will be accepted. When the mode is set to OUT, the UPS will make outgoing calls but will not accept incoming calls. When the mode is set to BOTH, both incoming and outgoing calls are enabled.

The Modem Present Field

The UPS periodically tests the modem to ensure that it is installed and responding properly. The result of these tests is displayed in the Modem Present field. When the UPS is powered up, the Modem Present field is initially a question mark (?), indicating that the test has not been performed and the UPS control system does not know whether or not a modem is installed. As long as the Modem Mode is OFF, the UPS will not perform the test, and the Modem Present field will display a question mark.

When the Modem Mode is changed from OFF to IN, OUT, or BOTH, the test will be enabled. If a modem is installed, the Modem Present field will change to 'Y' after a short delay. If a modem is not installed, not installed correctly, or defective, the Modem Present field will change to 'N'. The UPS may spend several minutes trying to get the modem to respond, so it may be a while before the field changes from '?' to 'N' if the modem is not present or not working.

The Call #2 Field

The "Call #2" field controls the logic used by the UPS to decide when to call the second of the two phone numbers. It has 3 possible settings: NEVER, #1 FAIL, and ALWAYS. When the field is set to NEVER, the UPS will only call phone number 1. When the field is set to ALWAYS, the UPS will always call both phone number 1 and phone number 2. When the field is set to #1 FAIL, the UPS will call the second number only if the first number is a pager or the first number is a modem and the UPS fails to establish a connection.



NOTE

The Modem Mode setting will override the Call #2 field—that is, the Call #2 field is irrelevant if the Modem Mode is set to OFF or IN, as both of these modes disable outgoing calls.

The Baud Rate Field

The Baud Rate (i.e., "data rate") field displays the rate in bits per second at which the UPS will communicate. Any device which wants to communicate with the UPS, whether it is a remote modem or a local terminal, must match the baud rate displayed in this field. The UPS can operate at either 2400 or 1200 baud (see **5.8.3 - Setting the Data Rate** for instructions on changing the setting).

5.8.2 Using the Modem

The modem option allows the UPS to communicate with the “outside world” over any standard analog telephone line. (Note that some in-house commercial phone systems use digital telephone lines designed to work with nonstandard telephone equipment. The modem in the UPS will not be able to communicate over these lines.)

There are several ways to communicate with the UPS using the modem; they are detailed separately in the following sections.

Incoming Calls

The UPS will answer incoming calls from another modem any time the UPS control logic has power, regardless of whether the load is on or off. Almost any ANSI compatible terminal equipped with a modem can be used as a remote monitoring and/or control station.

Alternatively, you can use a computer (IBM-PC or compatible, Macintosh, etc.) equipped with a modem and communication software as a remote station. Most PC communication software programs provide an ANSI terminal emulation mode which will work with the UPS. Programs such as Procomm, Telix, and the Microsoft Windows TERM.EXE have all been used successfully as remote monitoring stations.

Calling the UPS is no different than calling an online service such as CompuServe, or a computer bulletin board. The UPS is the host, and your terminal (or PC) is the remote. Because of the wide variety of terminals and communication software products available, it is not possible to provide step-by-step instructions which will be universally applicable. Consult the documentation for your communications software or terminal to find out how to connect to a remote host.

The UPS uses the following communication parameters:

Data rate (baud rate)	1200 or 2400 (see 5.8.3 - Setting the Data Rate)
Parity	None
Data Bits	8
Stop Bits	1
Terminal Emulation	ANSI (a popular “escape sequence” protocol which provides cursor movement and color control functions). Note that some PC software programs will work using VT-51, VT-52, VT-100, or other terminal emulation protocols. Many protocols are based on the basic ANSI set. Feel free to experiment, you can’t hurt the UPS or the computer.

Configuring the UPS to Accept Incoming Calls

- Before the UPS will answer any incoming calls, the Modem Mode setting must be set to either IN or BOTH (see **Setting the Modem Mode** in **5.8.1 - The Communication Mode Screen**). By default, the Modem Mode is set to OFF.

Outgoing Calls

The UPS can be configured to dial up to 2 numbers. Either of these numbers can be a pager or a modem. The UPS uses a priority system based on the settings of the Modem Mode and Call #2 Mode values (see **Setting the Modem Mode** in **5.8.1 - The Communication Mode Screen** when placing the calls).

If the Modem Mode is set to either OUT or BOTH, the UPS will dial out on any of the following events:

Table 10 Dial-Out Events

ID Code	Delay	Event
0	0	Dial-out test.
1	0	Automatic battery test failed.
3	60 Sec.	Alarm event, load is on inverter.
3	60 Sec.	Utility outage, load on inverter, battery discharging.
4	0	Low battery warning, load is in danger of shutdown.
5	60 Sec.	Load has been transferred to static switch. Overload or other alarm condition present.
6	0	Load has been shut down.

Each event has a delay and ID code. The ID code can be transmitted to a pocket pager to identify the event. The delay is the amount of time that the condition must be continuously present before a dial-out will occur. This delay exists to prevent the UPS from dialing out frequently in situations that may be very common. For example, in areas where the utility power is unreliable, power failures may be a daily event. The UPS will not dial out unless a power failure lasts at least 60 seconds.

Calling a Pager

When the UPS calls a pager, it uses the touch-tone generator in the modem to create the tones required by pager services. There are two numbers involved when calling a pager:

- The telephone number of the pager service access line (the service number)
- The number to be transmitted and displayed in the pager window (the display number)

Consider what happens when you place a call to a pager:

1. You dial the pager service number.
2. The pager service equipment picks up the phone after a few seconds—usually it beeps a few times. This is your cue to enter the display number.
3. When you're done entering the display number, you hit the pound (#) key to let the pager service know you're done.
4. Usually the pager service plays a recorded acknowledgment message.

Be aware that although the UPS has the ability to generate touch-tone signals which the pager service equipment can hear, the UPS cannot hear any sound generated by the pager service. Thus the UPS must “dial blind”—it dials the display number and hopes it was received properly. Since the UPS cannot hear either the cue or the acknowledgment, there is a chance that if the dial-out fails the UPS will have no way to know that it has failed. If this is a concern you may want to have the UPS call two different pagers, or a pager and a modem.

There are 2 fields on each of the UPS' phone number screens which you should understand when setting up a pager (read **Editing the Phone Numbers** in 5.8.2 - **Using the Modem** for more about how to edit the fields). When the UPS is first installed, the default phone number screens look like this:

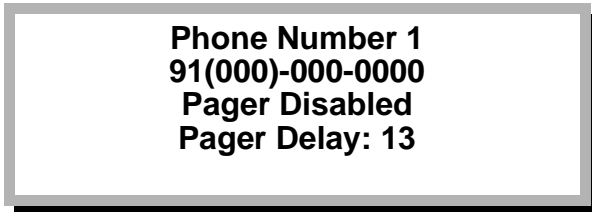

```
Phone Number 1
91(000)-000-0000
Pager Disabled
Pager Delay: 13
```

Line 2 should be edited to contain the service number. When you have finished editing the service number, the “Pager Disabled” field will begin to blink. At this point, pressing either the UP or DOWN buttons will cause line 3 to be replaced with an edit field for the display number:

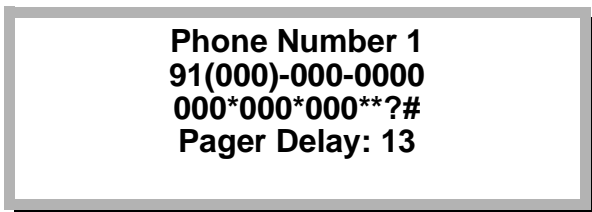

```
Phone Number 1
91(000)-000-0000
000*000*000**?#
Pager Delay: 13
```

Once this field is displayed, pager mode is enabled. Note: If you change your mind and want to disable pager mode, press either the UP or DOWN buttons while the first character on line 3 is blinking. At some point the “Pager Disabled” message will be displayed; you should then press ALARM SILENCE to continue.

Line 3 can be edited to contain the number you wish to appear in the pager window when the UPS dials out. It can be any number up to 15 digits long. Some users may want to put the telephone

number of the UPS in this field so that whoever has the pager can call the UPS with a PC when an event occurs.

There are several special characters which can appear in this field. The asterisk (*) will appear as a dash (-) in the pager window, making the display number easier to read. The question mark (?) will be replaced with the event ID code (see **Table 10**) if it is present in the field. The pound (#) character is required by most pager services to signal the end of the number. Space characters can be inserted for easier reading, they have no effect on the number transmitted.

The last field (line 4) specifies the number of seconds of delay between the time the UPS dials the pager service and the time it transmits the display number. The default value is 13 seconds. You may need to experiment with this value to achieve reliable results. An easy way to determine the correct value if the default does not work is to use a telephone to call the pager service number manually. Count the number of seconds from the time you hit the last digit of the service number until the moment you hear the cue. Adding 2 to 3 seconds to this time should be appropriate in most cases. If you add much more than that, some pager services may disconnect before they receive the display number. If you set the value too short, the UPS may transmit the display number before the pager service even answers the call.

You can reassure yourself that you have configured the system correctly by performing a dial-out test. See **Testing the Dial-Out Setup in 5.8.2 - Using the Modem**.

Calling a Modem

The most reliable method of remote event notification is to have the UPS call a terminal or computer equipped with a modem. When calling another modem the UPS can positively confirm that the connection succeeded and that the notification was transmitted—something which is not possible when it calls a pager service number.

The internal modem in the UPS is configurable for either 1200 or 2400 baud operation (see **5.8.3 - Setting the Data Rate**). When the UPS dials out, it will call each phone number a maximum of 3 times before giving up, unless the line is busy—in which case it will call up to 20 times before abandoning the attempt.

When the UPS connects with a remote modem, it first transmits the message “Press <SPACE BAR> to enter terminal mode.” This message will appear on the remote screen for a few seconds. If someone is watching the screen at the time the call from the UPS arrives, they can press the space bar on the terminal, and the UPS will enter the remote front panel mode. If the remote modem is attached to a computer which uses the Emerson Standard Protocol (ESP) for packet-oriented communication, the remote computer can use this opportunity to begin transmission (see **5.6.3 - Emerson Standard Protocol (ESP)** for more about ESP).

If the UPS does not receive a response to the “Press <SPACE BAR>” prompt, it will transmit a screen full of information describing the event which generated the dial-out. This screen includes the Site ID string, the current active alarms, and a one line summary message. When the UPS is done transmitting this screen, it sends another “Press <SPACE BAR> to enter terminal mode” prompt. At this point, the remote user has about 45 seconds to press the space bar or enter ESP mode. If the UPS receives no response to this prompt, it will hang up.

Editing the Phone Numbers

When editing the phone number or pager number fields, each time you press the ALARM SILENCE button the cursor will advance to the next character in the field. Each time you press the UP or DOWN arrow buttons the character located under the cursor will change. The set of characters which can be selected is any of the following:

! 0 1 2 3 4 5 6 7 8 9 - () , # W R T P @ * ; ?

The purpose of the characters 0 through 9 is obvious, but some of the others may need explanation:

Character	Explanation
!	Used to force the modem to perform a "hook flash" (i.e., hang up quickly and release) operation. Although rapidly fading from use, this mechanism is sometimes used in office phone systems to signal the local switchboard to listen for special codes to follow.
- () <SPACE>	These characters are used only to make the field more readable. They are ignored by the modem, and can be placed anywhere in the field.
,	The comma forces the modem to pause 2 seconds before continuing to dial. A typical use of this feature would be when the UPS is connected to a local phone system which requires you to dial '9' to get an outside line. Some systems may need the modem to pause for a bit after dialing 9 before an outside line can be assigned. In such an instance, you might see the complete dial string looking like this: 9, 555-8243.
W	Like the comma, the W command causes the modem to wait before continuing. The difference is that the comma imposes a fixed 2 second delay, while the W means "wait for a dial tone".
#	Used in pager display fields to signify the end of the number. Most pager service equipment require that the pound symbol be used to terminate an entry.
R	Stands for "Reverse." The R command is a prefix which tells the modem to connect with an originate-only modem. If the modem on the remote end answers silently (without asserting a carrier tone) you may be dealing with an originate-only modem. Such modems are rare these days. The R should be prefixed to any digits dialed, i.e., R 9, 555-8325.
T, P	Select tone or pulse dialing. Only one of these can be used in a given number. They are both prefixes, the T stands for tone (i.e., touch tone) and the P stands for pulse. By default, the modem uses tone dialing. If the UPS is connected to a phone line which requires pulse dialing, a P should be prefixed to the number, i.e., P 555-8325.
@	Use @ to dial a service that uses a recorded voice to request further information to be tone-dialed, such as a password and a transaction code: 555-8325 @ 9876. The modem dials the phone number, waits for one ring at the remote end, and then waits for 5 seconds before continuing to the next part of the dial string. The @ imposes a 5 second "quiet answer" pause.
*	Used in pager display strings to generate a separator character between fields in the display window. For example, if the pager display string is 555*8325, it will appear in the pager window as 555-8325.
;	Used to force the modem to return to command mode after dialing. Unless you are very familiar with modems and know exactly what you're doing, do not use this command.
?	This character, if present in a pager display string, will be replaced with the event ID code before being transmitted to the pager service equipment (see Table 10 for the list of ID codes and associated events). For example, if the modem is dialing a pager because of a battery test failed, the ? character would be replaced with the number 1 before being transmitted, and the number 1 would then appear in the pager display window at the same location in which it appeared in the pager display number field. The ? character has no meaning in a dial number (line 1) field, it should only be used in pager display (line 2) fields.

Testing the Dial-Out Setup

Once you have set the phone numbers, Modem Mode, and Call #2 field the way you want them, you'll probably want to know if it all works properly. That is what the Dial-out Test Screen is for:

```
Dial Test: OFF
Last Attempt(s):
#1: NONE
#1: NONE
```

To test your dial-out setup, change the Dial Test field from OFF to START. If you press ALARM SILENCE while the Dial Test field reads START, the dial-out test will begin. The sequence of events will be identical to the sequence that occurs when a 'real' dial-out event happens. For example, if the Call #2 field is set to #1 FAIL, the UPS will only call the second phone number if it can't connect to the first number, or if the first number is a pager.

While the dial-out test is in progress, the Last Attempt(s) fields will reflect the progress (or lack of progress) of the dial-out. **Note that these fields are active during any dial-out, whether or not it is a test. Since they retain the result of the last dial-out attempt, you can consult them to find out if a previous attempt succeeded or failed.** The fields will display one of the following messages:

Table 11 Last Attempt(s) Messages

Messages	Meaning
NONE	No dial-out has been attempted.
UNKNOWN	Displayed when UPS has called a pager. The UPS has no way to verify that the pager service equipment has received the message, and certainly no way to verify that the radio transmission to the pager was received or displayed. Although less common, this message will also be displayed if the UPS lost control power at the moment it was transmitting data to another modem. This means that the UPS is not sure the message got through.
NOT READY	The UPS cannot perform a dial-out at the moment because the modem is not ready. Usually this means that a modem presence test was in progress at the moment a dial-out request occurred. Try the dial-out test again in a minute or two. When an actual system event causes a dial-out, a NOT READY state will not be a problem—the UPS will wait until the modem test is done and then restart the dial-out.
DISABLED	Displayed in the #2 field if Call #2 is set to NEVER.
NO MODEM	The Modem Mode is set correctly, but the modem is either not installed, installed incorrectly, or defective.
OUT MODE OFF	The Modem Mode is set to OFF or IN, both disable dial-outs.
NO DIAL TONE	The modem is responding, but reports no dial tone found. Check the phone line connection.
BUSY	The phone line is busy. The UPS will retry the number 20 times before giving up.
NO CARRIER	The UPS is calling a remote modem, but the remote modem is not responding with a carrier tone.
DIALING	The modem is dialing and/or waiting for a response.
SENDING	The modem is transmitting the message to either a remote modem or pager service equipment.
PASSED	The dial-out succeeded: the UPS connected with a remote modem and transmitted the message.
FAILED	The dial-out failed, UPS was unable to connect and has given up.

If the current test is calling another modem, the Last Attempt(s) field should end with PASSED. If the current test is calling a pager, the Last Attempt(s) field should end at UNKNOWN.

5.8.3 Setting the Data Rate

The UPS has an RS-232-C serial port which is used to connect to either an internal modem, internal SNMP adapter, or an external customer interface. As shipped from the factory, the serial port is set for 2400 baud. If you need to change to 1200 baud (for example, to interface with an older terminal which doesn't support 2400 baud), you will need to move the baud rate jumper and

restart the UPS from position 1. This will mean your load will be supported by the raw utility power for the duration of the conversion and restart. It should not take more than 3 minutes if you are prepared.

The baud rate jumper is located on the microprocessor board (PN 02-792205-20). It is identified as W4 and W5. When the jumper is connected across W4, the baud rate is set for 2400, the factory default. If you remove the jumper from W4 and connect it across W5, the baud rate will change to 1200.

5.9 Optional SiteScan[®]/Sitemaster Interface

The SiteScan/Sitemaster Interface provides communication capability with Liebert site monitoring products. **Note: Use of this option precludes the use of the RS-232 interface port, internal modem, and internal SNMP options.** Required software level for the UPS module and site monitoring products is as follows:

- UPS Module: Rev. B or later
- Sitemaster: Version 3.0 or later
- SiteScan Model 50: Version 1.2 or later
- SiteScan Model 100: Version 1.2 or later
- SiteScan Model 101: Version 7.8 or later

Monitoring	Alarms
Input Voltage	Output Overload
Output Voltage	Load on Bypass
Output Current	Static Switch Disabled
Output Frequency	Unit Offline (EPO)
Output kVA	Module Cooling Failure
Output kW	Ambient Overtemperature
DC Voltage	Battery Discharging
Battery Current	Low Battery Reserve
% Capacity	Battery Disconnected
	Control Power Failure
	Fuse Cleared

A twisted-pair control wiring connection (by others) is required between the UPS module and site monitoring product. Refer to **Figure 8, Figure 9, or Figure 10** for wiring details.

5.10 Optional IBM[®] AS/400 Signal Interface

The IBM AS/400 Signal Interface provides a signal cable from the Liebert Series 300 UPS to activate the following status messages in the IBM system:

- UPS is supplying power
- Bypass is supplying power
- Battery discharging
- Low battery

The AS/400 requires this information to determine when to initiate a quick power down to preserve data and protect hardware during a utility power outage. The Series 300 UPS provides isolated normally open contacts and a shielded cable (50 ft.) with a 9-pin subminiature D-shell plug (male) connector to fit J24 on the IBM AS/400 9406 processor. This option is installed in the field. For wiring details refer to **Figure 27 or Figure 28**, depending on whether the Remote Status Panel option has also been selected.

5.11 Optional System/38 Power Warning Signal

The System/38 Power Warning Signal provides an isolated normally open contact for user connection to System/38 computer power warning circuitry. The contact closes when utility power fails and the UPS battery is discharging. A BNC connector is provided for connection to user supplied cable.

5.12 Optional Battery Circuit Breaker

An external Battery Circuit Breaker is available to provide a manual disconnecting means and overcurrent protection for external battery plants. This option is not required for use with factory supplied matching battery cabinets. The battery circuit breaker is provided in a separate NEMA Type 1 enclosure for wall mounting. The circuit breaker includes undervoltage release (UVR) and auxiliary contacts for field connection to the optional contact isolator board located in the UPS module. Refer to **Figure 29** and **Figure 30** for installation details.

5.13 Optional Contact Isolator Board

The Contact Isolator Board provides an interface at the UPS module to support the following optional system functions:

- External battery circuit breaker under voltage release (UVR)
- External battery circuit breaker auxiliary contact
- Reduced AC input current limit (100% of nominal) activated by external contact closure (by user)

Refer to **Figure 8**, **Figure 9**, or **Figure 10** for wiring details.

5.14 Optional DC Ground Fault Alarm

The DC Ground Fault Alarm provides annunciation of alarm condition when either the positive (+) or negative (-) DC bus is grounded. This option is installed in the field.

5.15 Optional Computer Interface System

The Computer Interface System performs an automatic unattended orderly shutdown of the customer's operating system when necessary. This option includes the software required to interface the UPS to the computer. The software monitors the UPS for power failure and low battery alarm while operating as a background task on the computer. After a power failure occurs, the software performs an automatic shutdown when the pre-programmed timer expires. If the UPS reaches a low battery alarm, the software will override the timer and perform an automatic shutdown.

This option requires the optional remote contact board to provide isolated normally closed contacts. This option includes a shielded interface cable with a 25-pin subminiature D-shell connector to fit the serial port of the computer file server. Cable is available in selected lengths from 25 to 300 feet. This option is installed in the field. Refer to **Figure 31** for wiring details.

5.16 Optional Multi-Computer Interface System

The Multi-Computer Interface System is designed for configurations where a single UPS is powering multiple computer file servers (up to 48). This option performs an automatic unattended orderly shutdown of the customer's operating system in each computer when necessary. The Multi-Interface Unit (MIU) provides the hardware required to interface the UPS to each computer. The software provided allows each computer to monitor the UPS for power failure and low battery alarm while operating as a background task on the computer. After a power failure occurs, the software performs an automatic shutdown of each computer when the pre-programmed timer expires. If the UPS reaches a low battery alarm, the software will override the timer and perform an automatic shutdown of each computer.

This option requires the optional remote contact board to provide isolated normally closed contacts. This option includes a shielded primary cable with a 9-pin subminiature D-shell connector, the Multi-Interface Unit (MIU), and shielded secondary cables with RJ11 and 25-pin subminiature D-shell connectors. Cables are available in selected lengths from 25 to 300 feet. This option is installed in the field. Refer to **Figure 32** for wiring details.

5.17 Optional IBM® AS/400 Multi-Interface System

The AS/400 Multi-Interface System is designed for configurations where a single UPS is powering multiple AS/400 units (up to 8). The Multi-Interface Unit (MIU) provides the required UPS status information to each AS/400 so it can perform an automatic unattended orderly shutdown when necessary. Each AS/400 includes the software required to interface with the UPS. The following status messages are activated in the IBM system:

- UPS is supplying power
- Bypass is supplying power
- Battery discharging
- Low battery

Each AS/400 individually monitors the UPS status to determine when to initiate a quick power down to preserve data and protect hardware during a utility power outage.

This option requires the optional remote contact board to provide isolated contacts. This option includes a shielded primary cable with a 9-pin subminiature D-shell connector, the AS/400 Multi-Interface Unit (MIU), and shielded secondary cables with RJ11 and 9-pin subminiature D-shell connectors. Cables are available in selected lengths from 25 to 300 feet. This option is installed in the field. Refer to **Figure 33** for wiring details.

Figure 22 Optional Maintenance Bypass Cabinet

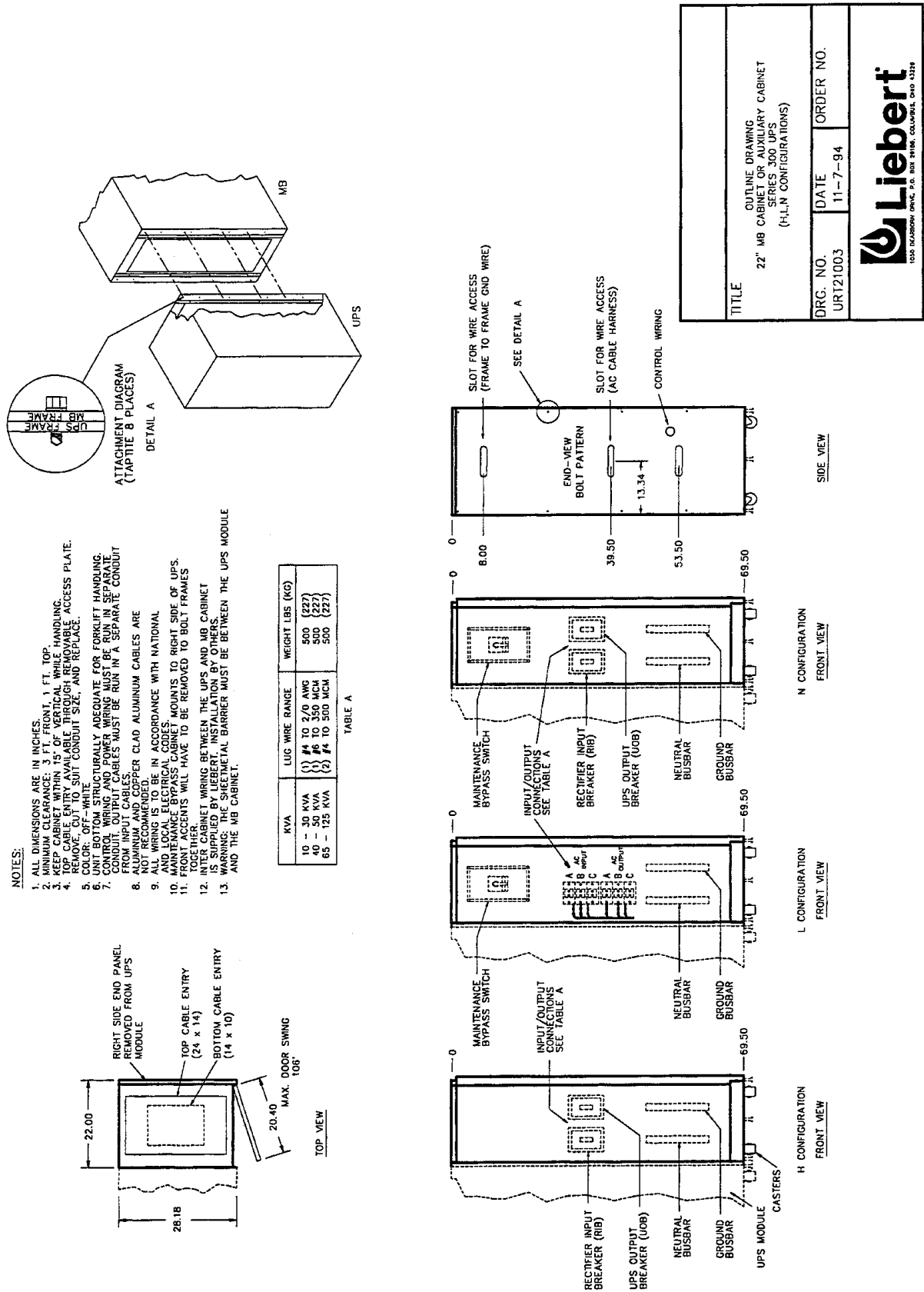
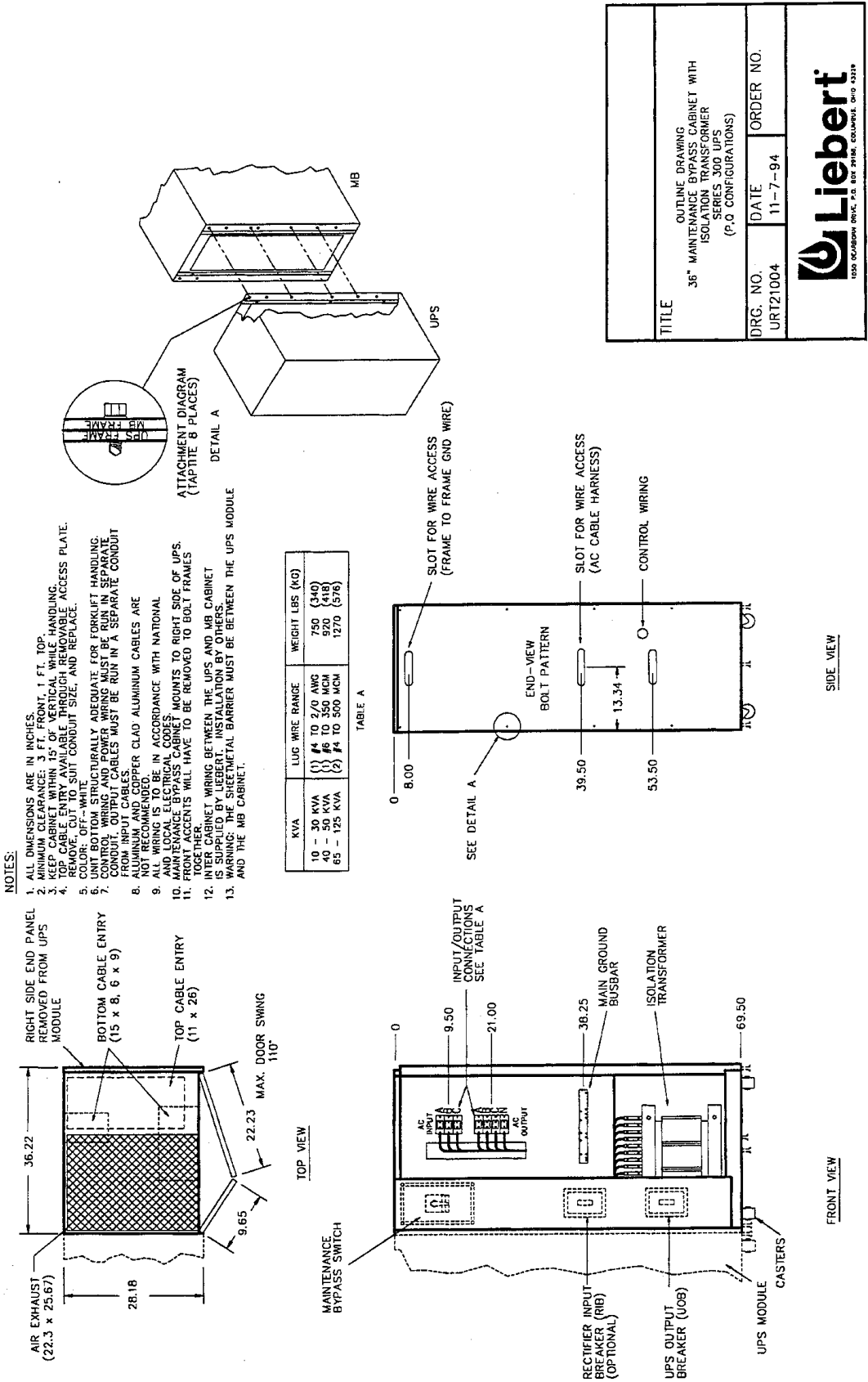

Figure 23 Optional Maintenance Bypass Cabinet with Isolation Transformer



TITLE	
OUTLINE DRAWING 36" MAINTENANCE BYPASS CABINET WITH ISOLATION TRANSFORMER SERIES 300 UPS (P-D CONFIGURATIONS)	
DWG. NO.	ORDER NO.
URT21004	11-7-94
DATE	
11-7-94	



Figure 24 Optional Slim-Line Distribution

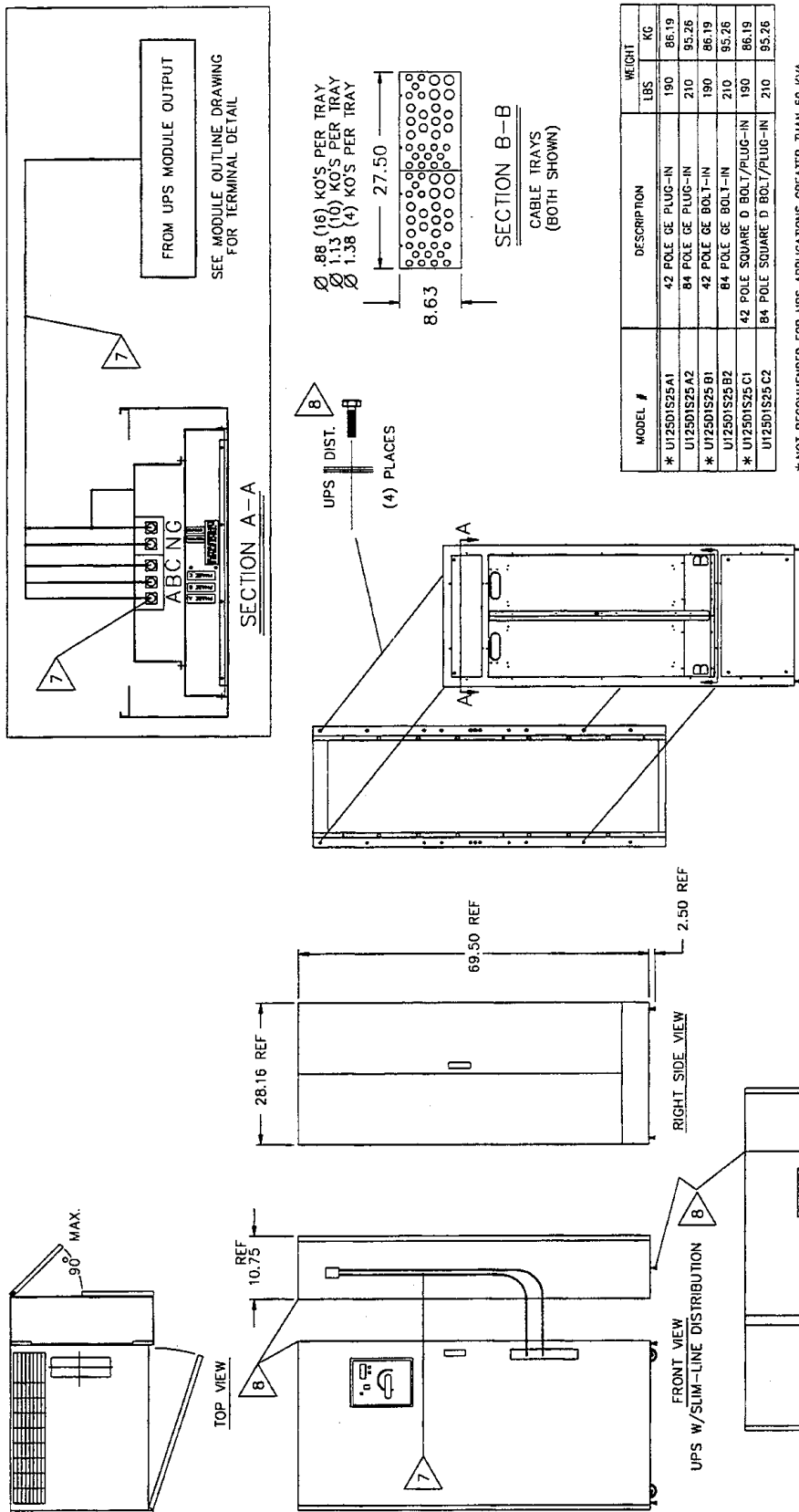

SHEET 1 OF 2	
TITLE INSTALLATION INSTRUCTIONS OPTIONAL SLIM-LINE DISTRIBUTION SERIES 300 UPS	
DRG. NO. URT11012	DATE 2-13-95
ORDER NO.	
 <small>1000 EASTWIND DRIVE, P.O. BOX 3188, COVINGTON, LA 70433</small>	

1. REMOVE EXTERIOR PACKING AND INSPECT FOR ANY DAMAGE THAT MAY HAVE OCCURRED DURING SHIPPING.
 2. OPEN DOORS AND REMOVE LOWER AND TOP FRONT ACCENTS. SAVE HARDWARE FOR REINSTALLATION.
 3. REMOVE LAG BOLTS AND DISCARD.
 4. REMOVE CABLE ACCESS COVER PLATE FROM REAR OF SLIM LINE FOR WIRING ACCESS TO UPS.
 5. UNIT IS NOW READY FOR INSTALLATION TO UPS.
- ⓑ REMOVE RIGHT SIDE PANEL FROM UPS.
- ⓑ INSTALL OUTPUT, GROUND AND NEUTRAL CABLE CONNECTIONS PER WIRING DIAGRAM. TORQUE TO 275 IN. LBS.
- ⓑ ALL WIRING TO BE IN ACCORDANCE WITH NATIONAL ELECTRICAL CODES.
- ⓑ ALIGN TOP OF SLIM LINE CABINET WITH TOP OF UPS USING LEVELERS TO ADJUST HEIGHT. SLIM LINE CABINET SHOULD BE FLUSH WITH TOP OF UPS. VERIFY ALL WIRING HARDWARE LOCATED IN INSTALLATION PANEL IS OPEN IN RIGHT HAND DOOR.
- ⓑ REINSTALL TOP AND BOTTOM FRONT ACCENTS USING EXISTING HARDWARE.

Figure 24 Optional Slim-Line Distribution (continued)

- NOTES:
1. PANELBOARDS ARE 42 POLE, 225 AMPS.
 2. PANELBOARD MAIN CIRCUIT BREAKER IS RATED AT 225 AMPS.

MINIMUM INTERCONNECT WIRING		WIRING LEGEND
UPS KVA	AVG. SIZE (COPPER)	FIELD SUPPLIED
10-15	1/0	FACTORY SUPPLIED
20-30	1/0	
40-50	1/0	
65-75	2/0	
100-125	350 MCM	

WIRE SIZE IS BASED ON AMPACITIES GIVEN IN TABLE 310-17 OF THE NATIONAL ELECTRIC CODE USING 75°C COPPER WIRE.

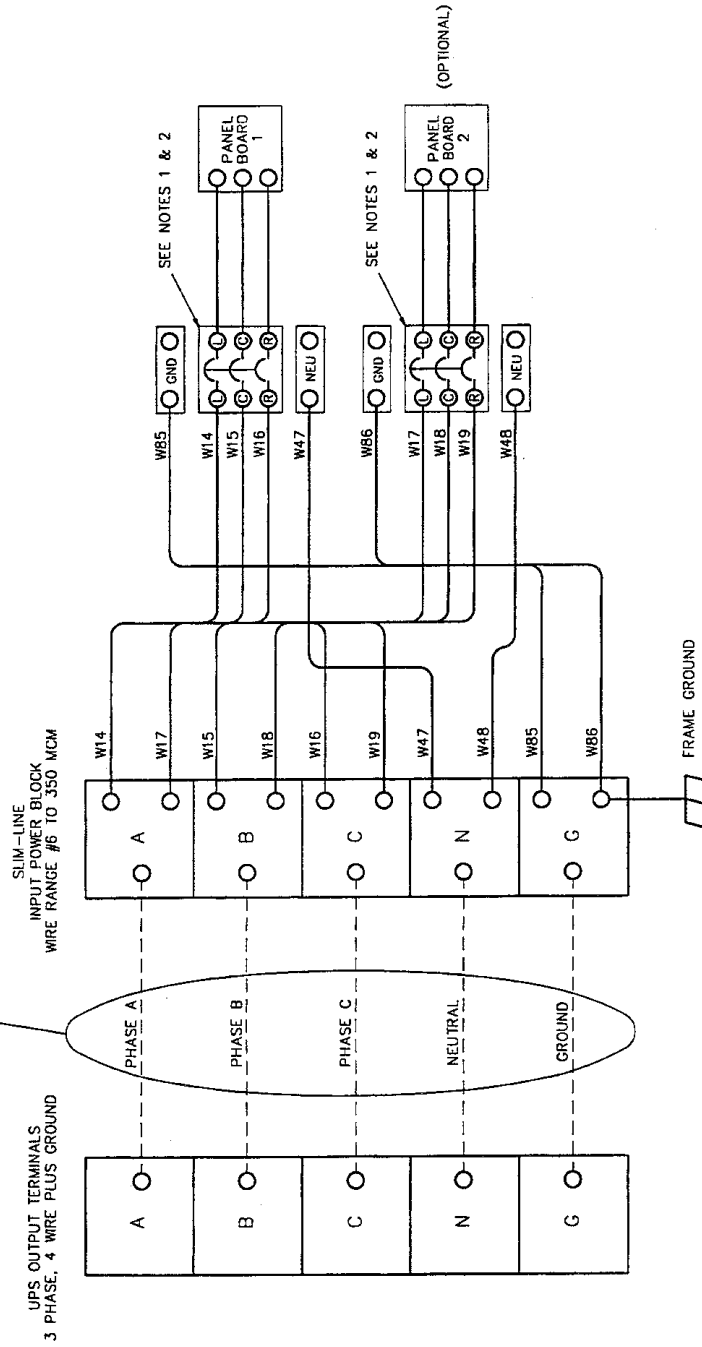

DRG. NO. URT11013		DATE 9-29-94		ORDER NO.	
SHEET 2 OF 2			TITLE INSTALLATION INSTRUCTIONS OPTIONAL SLIM-LINE DISTRIBUTION SERIES 300 UPS		



Figure 25 Optional Remote Status Panel

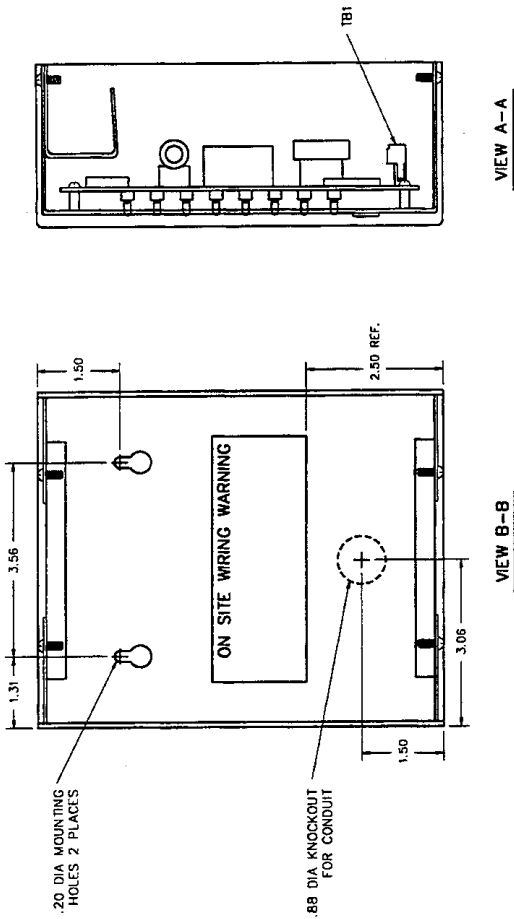

- NOTES:
1. ALL DIMENSIONS ARE IN INCHES.
 2. NEMA 1 TYPE ENCLOSURE.
 3. COLOR: OFF-WHITE
 4. APPROXIMATE WEIGHT: 5 LBS.
 5. ALL CONTROL WIRING (BY OTHERS) MUST BE RUN IN SEPARATE RIGID STEEL CONDUIT FROM POWER WIRING.

TITLE		INSTALLATION DRAWING SERIES 300 REMOTE STATUS PANEL SURFACE MOUNT	
DRG. NO.	DATE	ORDER NO.	
URT14001	10-12-94		

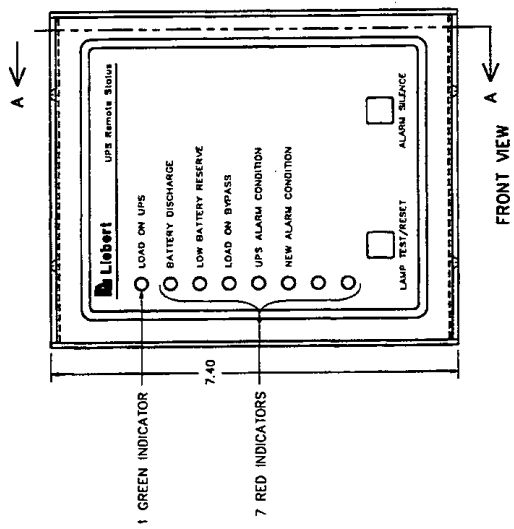
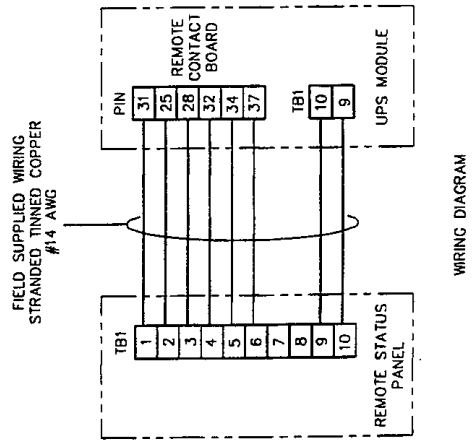
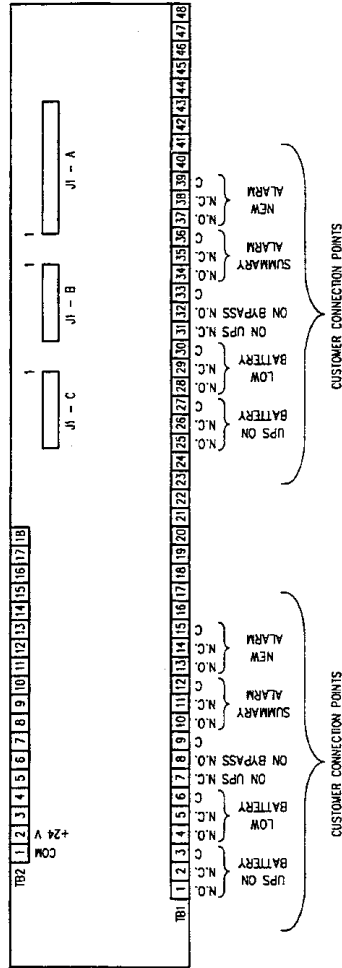

Figure 26 Optional Remote Contact Board

WIRING DIAGRAM
REMOTE CONTACT BOARD OPTION



NOTES:

1. ALL CONTROL WIRING (BY OTHERS) MUST BE RUN SEPARATE FROM POWER WIRING. CONTROL WIRING RUNS SHOULD NOT BE COMBINED IN THE SAME CONDUIT.
2. REFER TO CONTROL WIRING DRAWING FOR LOCATION OF OPTIONAL REMOTE CONTACT BOARD.
3. ALL WIRING IS TO BE IN ACCORDANCE WITH NATIONAL AND LOCAL ELECTRICAL CODES.
4. N.O. = NORMALLY OPEN
N.C. = NORMALLY CLOSED
C = COMMON
5. CONTACT RATINGS
0.5A @ 30 VAC
2.0A @ 30 VDC

TITLE	
INSTALLATION DRAWING SERIES 300 UPS REMOTE CONTACT BOARD	
DRG. NO. URT14004	DATE 10-17-94
ORDER NO.	
 <small>1050 CALABASH DRIVE, P.O. BOX 21188, COLUMBUS, OHIO 43229</small>	

Figure 27 Optional IBM® AS/400 Signal Interface

WIRING DIAGRAM
AS/400 INTERFACE OPTION

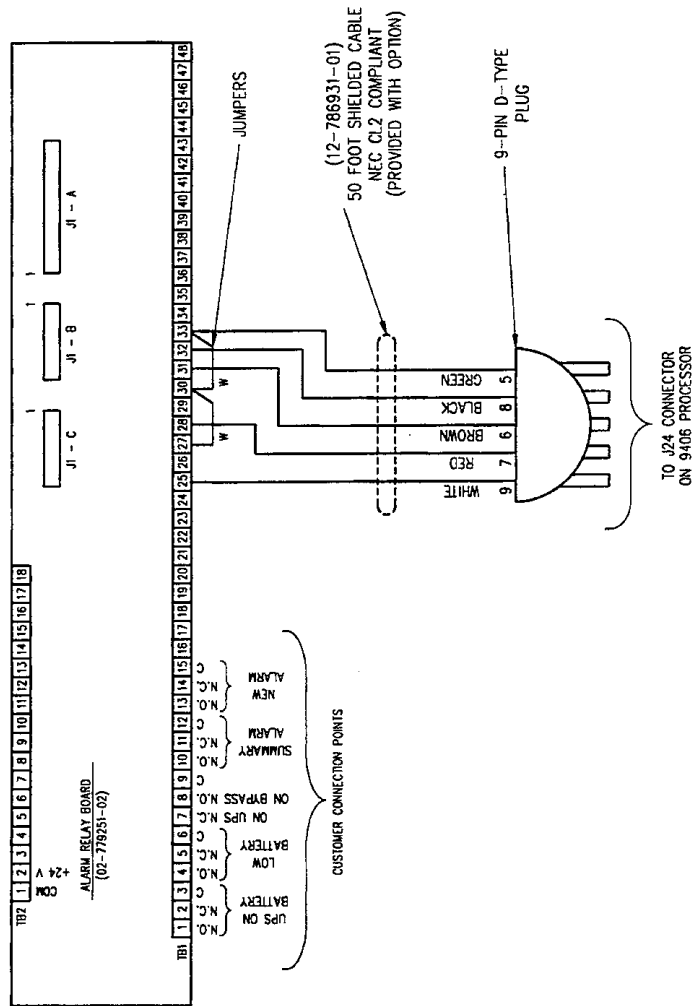

NOTES:

1. ALL CONTROL WIRING (BY OTHERS) MUST BE RUN SEPARATE FROM POWER WIRING. CONTROL WIRING RUNS SHOULD NOT BE COMBINED IN THE SAME CONDUIT.
2. REFER TO CONTROL WIRING DRAWING FOR LOCATION OF OPTIONAL ALARM RELAY BOARD.
3. ALL WIRING IS TO BE IN ACCORDANCE WITH NATIONAL AND LOCAL ELECTRICAL CODES.
4. N.O. = NORMALLY OPEN
N.C. = NORMALLY CLOSED
C = COMMON

TITLE		INSTALLATION DRAWING SERIES 300 UPS AS/400 INTERFACE OPTION	
DRG. NO.	DATE	ORDER NO.	
URT14005	10-12-94		
		1530 DUNBAR DRIVE, P.O. BOX 21189, COLOMBUS, OHIO 43219	

Figure 28 Optional IBM® AS/400 Signal Interface (with Remote Status Panel)

WIRING DIAGRAM
AS/400 INTERFACE OPTION
AND
REMOTE STATUS PANEL OPTION

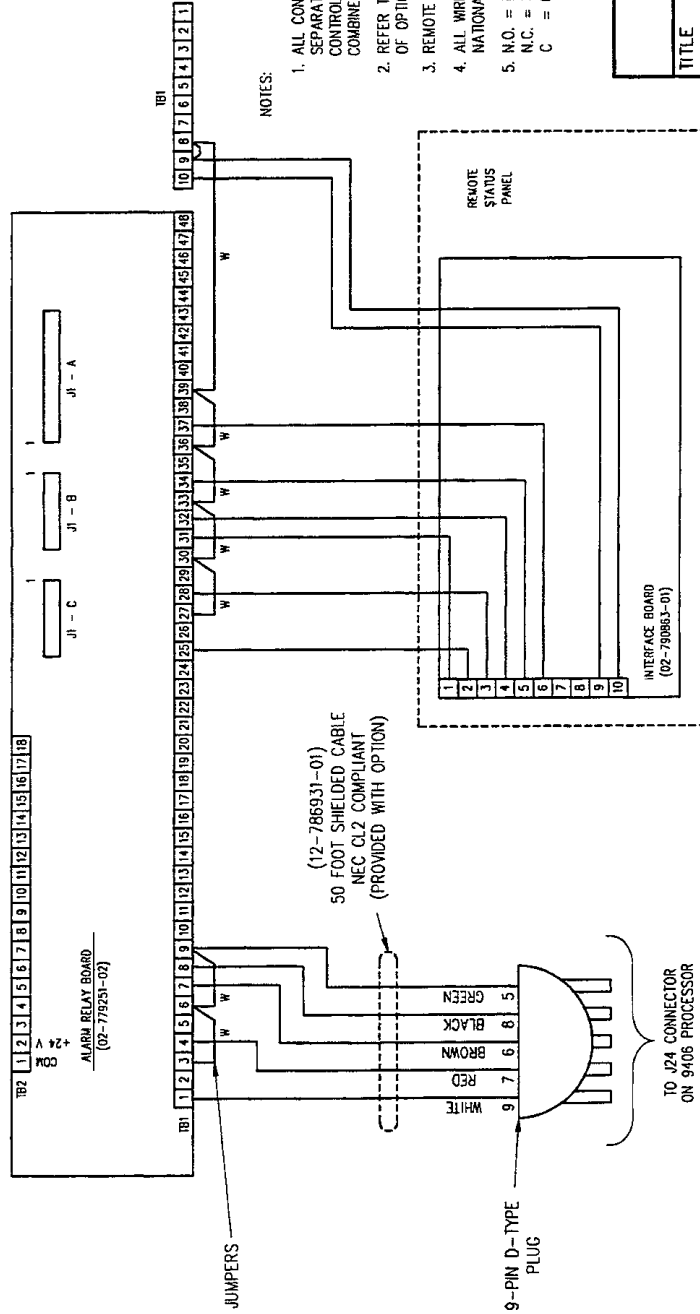

NOTES:

1. ALL CONTROL WIRING (BY OTHERS) MUST BE RUN SEPARATE FROM POWER WIRING. CONTROL WIRING RUNS SHOULD NOT BE COMBINED IN THE SAME CONDUIT.
2. REFER TO CONTROL WIRING DRAWING FOR LOCATION OF OPTIONAL ALARM RELAY BOARD.
3. REMOTE STATUS PANEL IS OPTIONAL.
4. ALL WIRING IS TO BE IN ACCORDANCE WITH NATIONAL AND LOCAL ELECTRICAL CODES.
5. N.O. = NORMALLY OPEN
N.C. = NORMALLY CLOSED
C = COMMON

TITLE	
INSTALLATION DRAWING SERIES 300 UPS AS/400 INTERFACE OPTION AND REMOTE STATUS PANEL OPTION	
DRG. NO.	ORDER NO.
UR114006	10-12-94
 <small>1535 BUCKLEBOURNE DRIVE, P.O. BOX 511600, DALLAS, TEXAS 75251</small>	

Figure 29 Optional Battery Circuit Breaker 10-75 kVA



KVA	FRAME	TRIP	DIMENSIONS					LUG WIRE RANGE		WEIGHT
			A	B	C	D	E	(1) #14 TO #2/0 AWG	(2) #4 TO 300 MCM	
10 - 30	100	100	18.12	8.62	13.87	6.00	4.12		20	
40 - 50	225	150	28.62	12.38	24.25	9.50	5.43		28	
65 - 75	225	225	28.62	12.38	24.25	9.50	5.43		28	

NOTES:

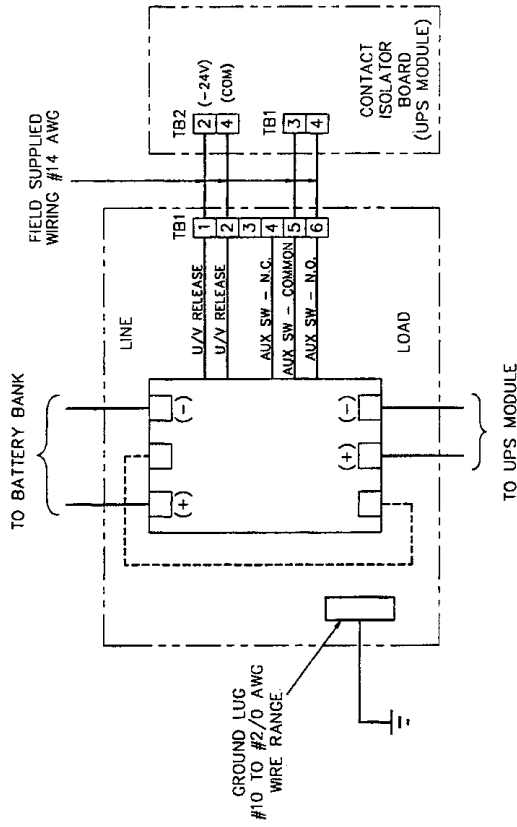
1. ALL DIMENSIONS ARE IN INCHES.
2. NEMA TYPE 1 ENCLOSURE FOR WALL MOUNTING.
3. COLOR: GRAY.
4. ALL WIRING IS TO BE IN ACCORDANCE WITH NATIONAL AND LOCAL ELECTRICAL CODES.
5. CONTROL WIRING IS RECOMMENDED TO BE #14 AWG STRANDED TINNED COPPER.
6. CONTROL WIRING (BY OTHERS) MUST BE RUN IN A SEPARATE RIGID STEEL CONDUIT FROM POWER WIRING.

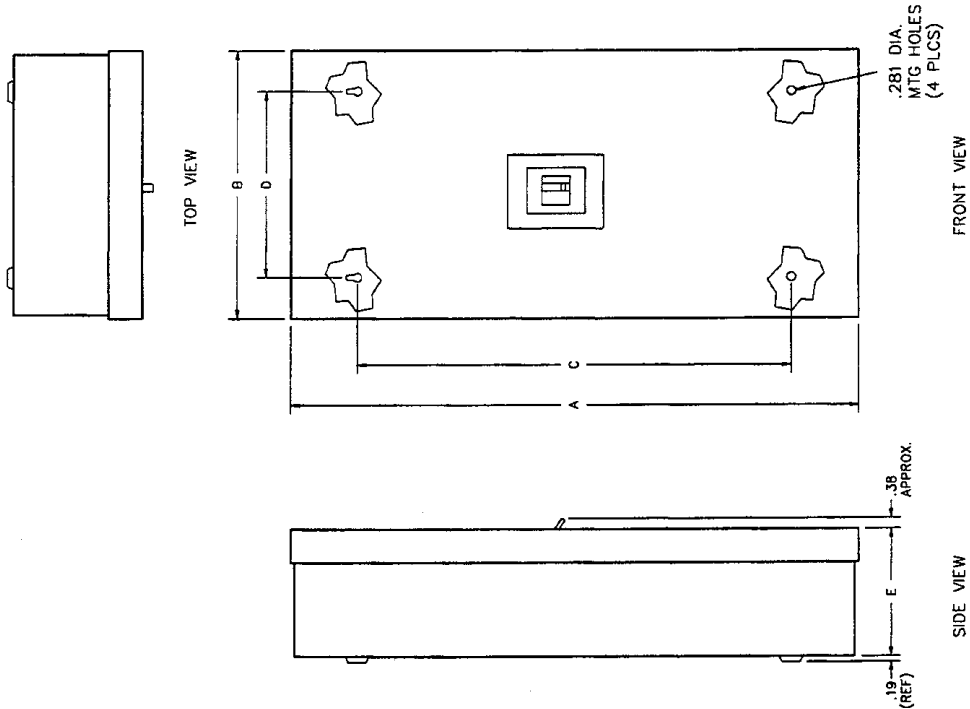

TITLE	
INSTALLATION DRAWING SERIES 300 UPS DESIGN SERIES 25 BATTERY CIRCUIT BREAKER WITH INTERFACE 10 TO 75 KVA UPS MODULES	
DRG. NO.	ORDER NO.
URT14002	10-12-94
 <small>1000 BROADVIEW DRIVE, P.O. BOX 21861, COLUMBUS, OHIO 43228</small>	

Figure 30 Optional Battery Circuit Breaker 100-125 kVA



FRAME	TRIP	LUG WIRE RANGE	WEIGHT
400A	400A	(1) #1 TO 600 MCM OR (2) #1 TO 250 MCM	50

NOTES:

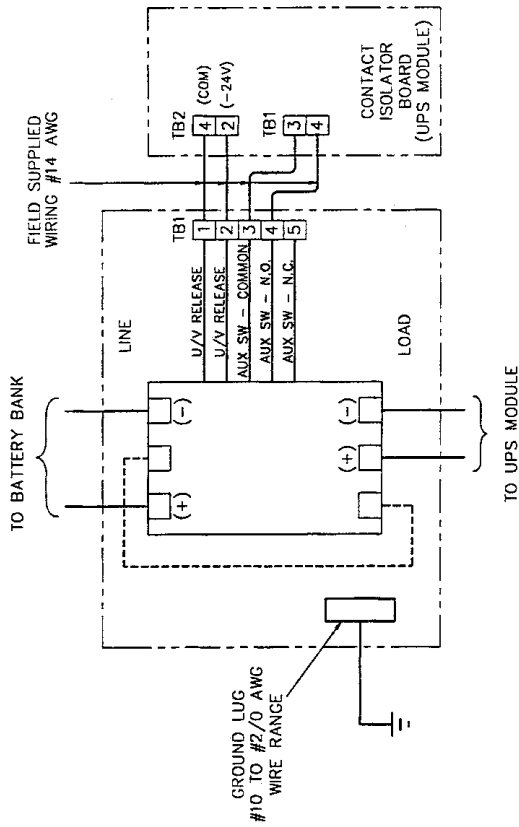
1. ALL DIMENSIONS ARE IN INCHES.
2. NEMA TYPE 1 ENCLOSURE FOR WALL MOUNTING.
3. COLOR: GRAY.
4. ALL WIRING IS TO BE IN ACCORDANCE WITH NATIONAL AND LOCAL ELECTRICAL CODES.
5. CONTROL WIRING IS RECOMMENDED TO BE #14 AWG STRANDED TINNED COPPER.
6. CONTROL WIRING (BY OTHERS) MUST BE RUN IN A SEPARATE RIGID STEEL CONDUIT FROM POWER WIRING.

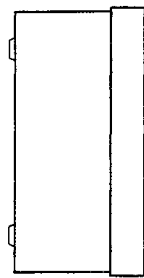

TOP VIEW

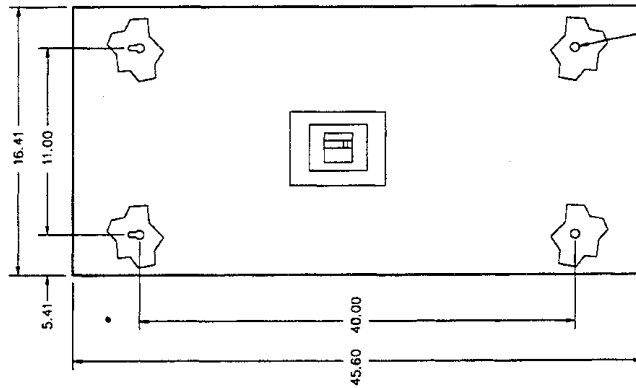

FRONT VIEW

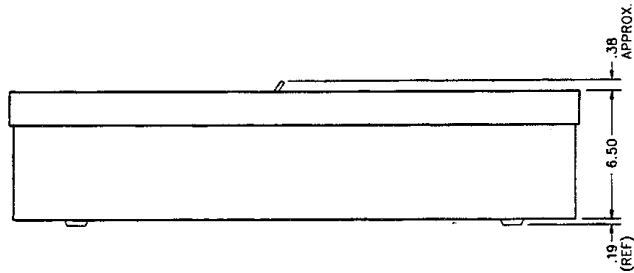

SIDE VIEW

TITLE	
INSTALLATION DRAWING	
SERIES 300 UPS DESIGN SERIES 25	
BATTERY CIRCUIT BREAKER WITH INTERFACE	
100 TO 125 KVA UPS MODULES	
DRG. NO.	DATE
URT14003	10-12-94
ORDER NO.	
 <small>1000 DARBORN DR., P.O. BOX 78186, COLUMBUS, OHIO 43228</small>	

Figure 31 Optional Computer Interface System

WIRING DIAGRAM
COMPUTER INTERFACE OPTION

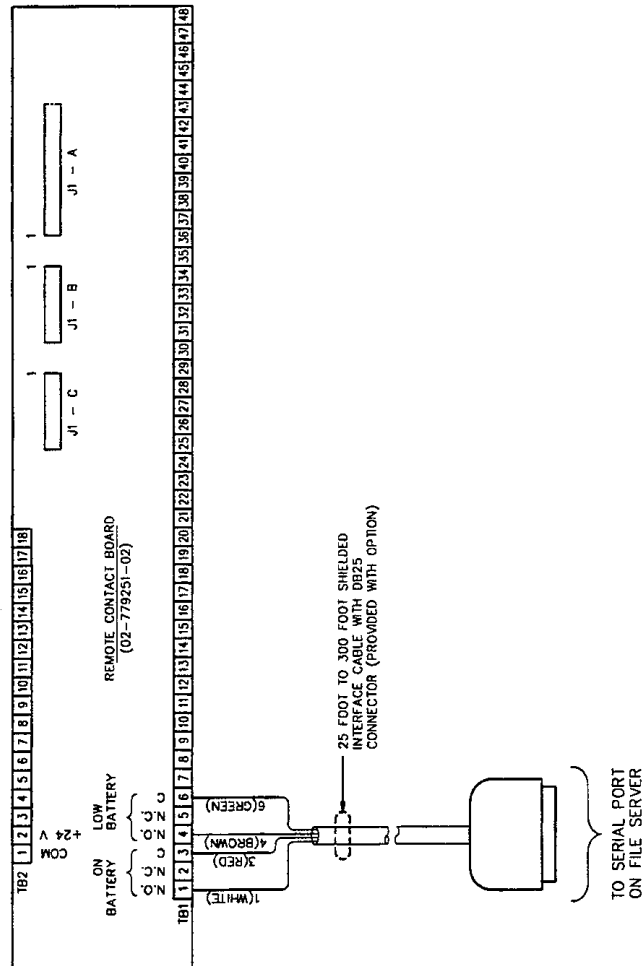

NOTES:

1. WIRE BARE END OF THE COMPUTER INTERFACE CABLE TO THE OPTIONAL REMOTE CONTACT BOARD LOCATED INSIDE THE UPS.
2. PLUG THE DB25 CONNECTOR INTO SERIAL PORT ON THE FILE SERVER.
3. INSTALL SOFTWARE ON THE FILE SERVER PER INSTALLATION MANUAL. (PROVIDED WITH OPTION)
4. ALL WIRING IS TO BE IN ACCORDANCE WITH NATIONAL AND LOCAL ELECTRICAL CODES.
5. N.O. = NORMALLY OPEN
N.C. = NORMALLY CLOSED
C = COMMON

TITLE		INSTALLATION DRAWING SERIES 300 UPS COMPUTER INTERFACE OPTION	
DRG. NO.	DATE	ORDER NO.	
URT14007	10-12-94		
		1000 DUBUQUE DRIVE, P.O. BOX 31194, COLUMBUS, OHIO 43234	

Figure 32 Optional Multi-Computer Interface System



NOTES:

1. WIRE BARE END OF THE PRIMARY INTERFACE CABLE TO THE OPTIONAL REMOTE CONTACT BOARD LOCATED INSIDE THE UPS. REFER TO CONTROL WIRING DRAWING FOR LOCATION OF THE REMOTE CONTACT BOARD. PLUG THE DB9 CONNECTOR INTO THE MULTI-INTERFACE UNIT (MIU).
2. THE RJ11 CONNECTOR ON THE SECONDARY MIU CABLE IS PLUGGED INTO THE SERIAL PORT ON THE FILE SERVER.
3. INSTALL SOFTWARE ON THE FILE SERVER PER INSTALLATION MANUAL. (PROVIDED WITH OPTION)
4. ALL WIRING IS TO BE IN ACCORDANCE WITH NATIONAL AND LOCAL ELECTRICAL CODES.
5. N.O. = NORMALLY OPEN
N.C. = NORMALLY CLOSED
C = COMMON
6. MULTI-INTERFACE UNIT IS DESIGNED FOR SYSTEM CONFIGURATIONS IN WHICH A SINGLE UPS POWERS FROM 4 TO 48 INDEPENDENT FILE SERVERS.

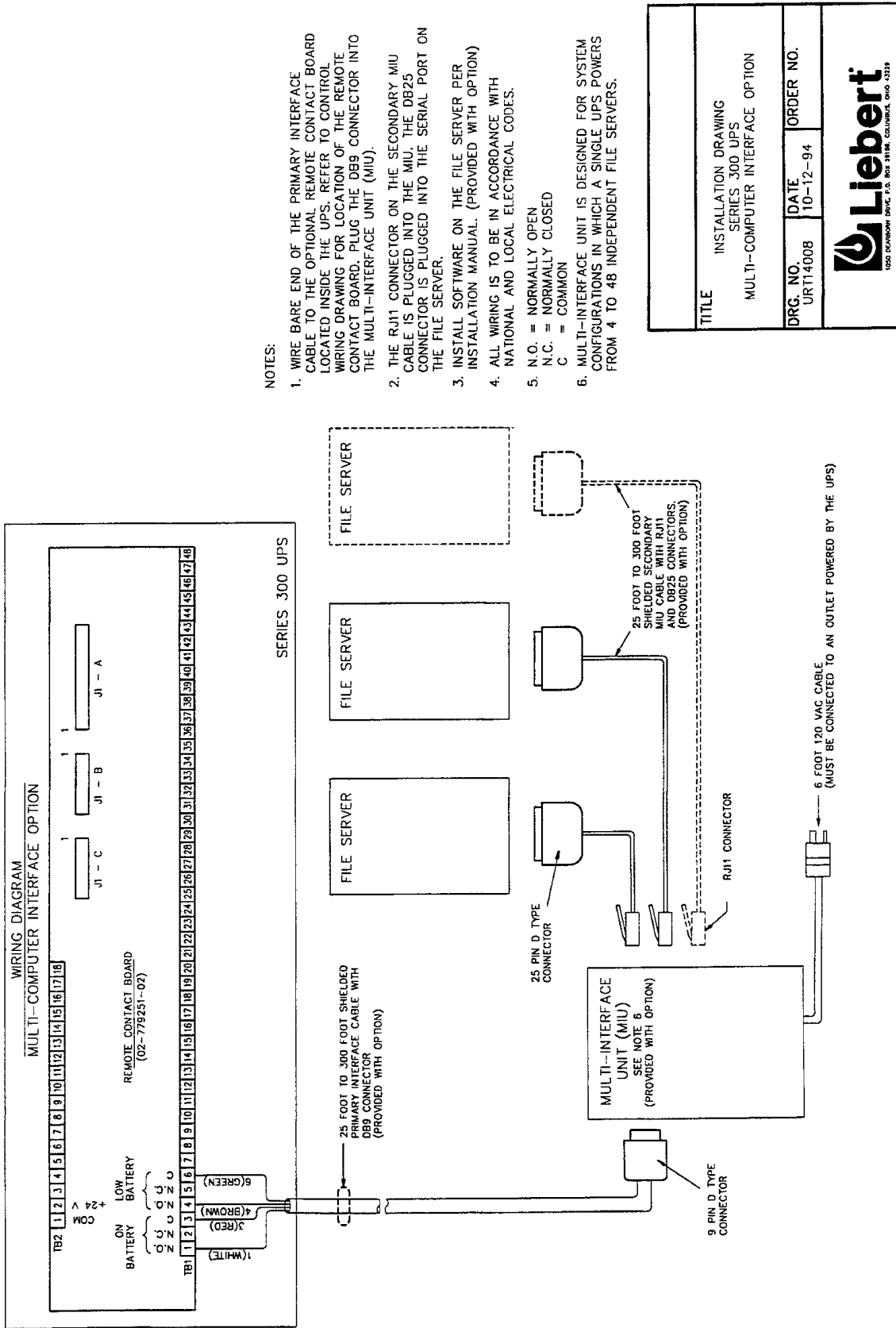

TITLE		INSTALLATION DRAWING	
		SERIES 300 UPS	
		MULTI-COMPUTER INTERFACE OPTION	
DRG. NO.	DATE	ORDER NO.	
URT1400B	10-12-94		
 1050 DORNBURG DR. F.O. BOX 11116, COLLEGE, MO. 63213			

Figure 33 Optional IBM® AS/400 Multi-Interface System

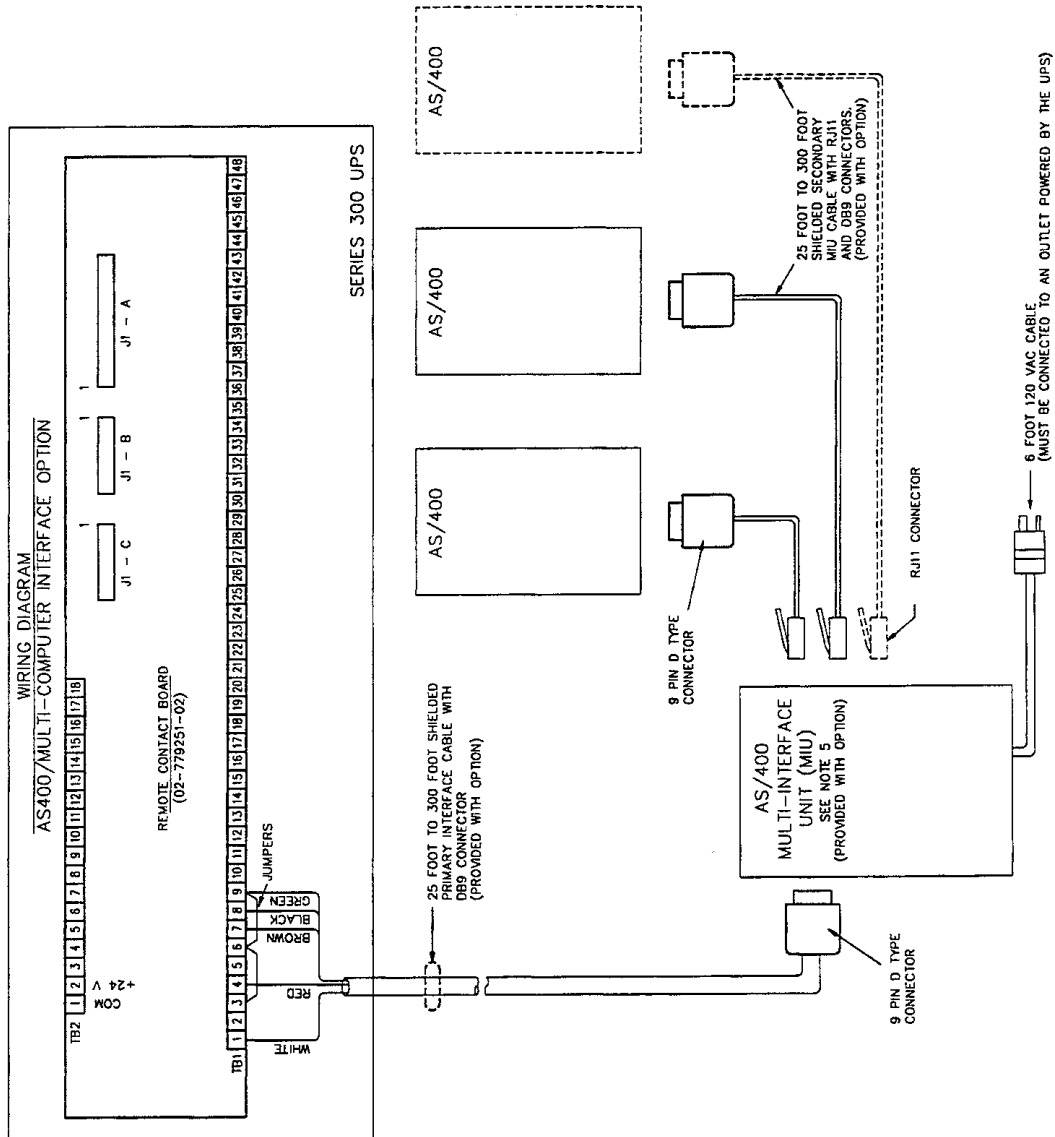

NOTES:

1. WIRE BARE END OF THE PRIMARY INTERFACE CABLE TO THE OPTIONAL REMOTE CONTACT BOARD LOCATED INSIDE THE UPS. REFER TO CONTROL WIRING DRAWING FOR LOCATION OF THE REMOTE CONTACT BOARD. PLUG THE DB9 CONNECTOR INTO THE AS/400 MULTI-INTERFACE UNIT (MIU).
2. THE RJ11 CONNECTOR ON THE SECONDARY MIU CABLE IS PLUGGED INTO THE MIU. THE DB9 CONNECTOR IS PLUGGED INTO THE SERIAL PORT ON THE AS/400.
3. ALL WIRING IS TO BE IN ACCORDANCE WITH NATIONAL AND LOCAL ELECTRICAL CODES.
4. N.O. = NORMALLY OPEN
N.C. = NORMALLY CLOSED
C = COMMON
5. MULTI-INTERFACE UNIT IS DESIGNED FOR SYSTEM CONFIGURATIONS IN WHICH A SINGLE UPS POWERS FROM 4 TO 8 INDEPENDENT AS/400.

TITLE		INSTALLATION DRAWING	
AS/400/MULTI-COMPUTER INTERFACE OPTION		SERIES 300 UPS AS/400	
DRG. NO.	DATE	ORDER NO.	
URT14009	10-12-94		
 <small>1000 CARRISON DRIVE, P.O. BOX 3148, COLUMBUS, OHIO 43218</small>			

6.0 SPECIFICATIONS

6.1 Electrical Specifications

The UPS shall meet or exceed the following electrical specifications:

6.1.1 AC Inputs to UPS

Voltage Configuration:

Three-Phase, 3-wire-plus ground with standard input isolation transformer

Voltage Range:

+10%, -15% of nominal

Frequency:

Nominal frequency \pm 5%

Power Factor:

0.80 lagging minimum at nominal input voltage and full rated UPS output load

0.90 lagging with optional input filter

Inrush Current:

800% of full load current maximum

Current Limit:

125% of nominal AC input current maximum

Input Current Walk-In:

20 seconds to full rated input current maximum. Field selectable 5 or 20 seconds.

Current Distortion:

30% THD at full load. 10% THD with optional input filter.

Surge Protection:

Sustains input surges without damage per criteria listed in ANSI C62.41-1980

6.1.2 AC Output. UPS Inverter

Voltage Configuration:

Three-Phase, 4-wire-plus-ground

Voltage Regulation:

±1% for balanced load

Voltage Unbalance:

Balanced load ±1%

20% unbalanced load ±1%

50% unbalanced load ±2%

100% unbalanced load ±5%

Voltage Adjustment Range:

±5% manual adjustment

Frequency:

Nominal frequency ±0.1%

Frequency Slew Rate:

1.0 Hertz per second maximum. Field selectable from 0.1 to 1.0 Hz per second.

Bypass Line Sync Range:

±0.5, ±1.0, ±3.0 Hertz. Field selectable.

Load Power Factor Range:

0.9 leading to 0.5 lagging

Output Power Rating:

Rated kVA at 0.8 lagging power factor

Voltage Distortion:

5% total harmonic distortion (THD); 3% maximum for any single harmonic, for linear loads

Phase Displacement:

±1° for balanced load

±3° for 50% unbalanced load

Voltage Transient Response:

20% load step ±4%

30% load step ±5%

50% load step ±8%

Loss or return of AC input power ±1%

Manual transfer of 100% load ±4%

Transient Recovery Time:

To within 1% of output voltage within 50 milliseconds

Overload Capability:

125% for 10 minutes (without bypass source). 150% for 30 seconds (without bypass source).

Fault Clearing:

Sub cycle current of at least 300%

6.2 Ratings

The UPS nameplate displays the rated kVA and kW values as well as nominal voltages and operation of the unit. Refer to **Table 1** for model numbers and kVA/kW ratings.

6.3 Environmental Specifications

Temperature Range:

- **Operating:**

UPS: 0°C to 40°C

Battery: 25°C ±5°C

- **Storage:**

UPS: -20°C to +70°C

Battery: -40°C to +40°C

Relative Humidity:

0 to 95% non-condensing

Audible Noise:

65 dBA at 1 meter

Altitude:

0 to 6560 feet (2000 meters). Derated for higher elevations.

6.4 Mechanical Specifications

Refer to **Table 2** and **Table 3** for UPS module mechanical specifications.

6.5 Battery

Battery Type: Sealed, lead-acid, in matching cabinet

kVA	DC Voltage Range	Number of Cells
10 - 15	163V - 240V	102
20 - 125	288V - 423V	180

Table 12 Matching Battery Cabinets

Battery Cabinet Model Number*	UPS Rating kVA	Dimensions WxDxH	Weight Lb (Kg)	Dist. Floor Loading Lb/Sq Ft	No. of Cells	Standard Cabinet Battery Model No.*	Computer Room Cabinet Battery Model No.*
UBCB_140V25YJ	10 - 15	22x28x72 in.	760 (345)	178	1x102	UPS12-140	UPS12-140FR
UBCB_170V25YJ	10 - 15	22x28x72 in.	1000 (454)	234	1x102	UPS12-170	UPS12-170FR
UBCB_270V25YJ	10 - 15	22x28x72 in.	1300 (590)	304	1x102	UPS12-270	UPS12-270FR
UBCB_370V25YJ	10 - 15	22x28x72 in.	1650 (748)	386	1x102	UPS12-370	UPS12-370FR
UBCB_475V25YJ	10 - 15	22x28x72 in.	2100 (953)	491	1x102	UPS12-475	UPS12-475FR
UBCB_100H25YJ	20 - 30	22x28x72 in.	990 (450)	232	1x180	UPS12-100	UPS12-100FR
UBCB_140H25YJ	20 - 50	22x28x72 in.	1150 (522)	269	1x180	UPS12-140	UPS12-140FR
UBCB_170H25YJ	20 - 50	22x28x72 in.	1500 (680)	351	1x180	UPS12-170	UPS12-170FR
UBCP_270H25JJ	20 - 50	36x28x72 in.	2050 (930)	293	1x180	UPS12-270	UPS12-270FR
UBCP_310H25JJ	20 - 50	36x28x72 in.	2500 (1134)	358	1x180	UPS12-310	UPS12-310FR
UBCP_370H25JJ	20 - 50	36x28x72 in.	2750 (1247)	393	1x180	UPS12-370	UPS12-370FR
UBCP_475H25JJ	20 - 50	36x28x72 in.	3500 (1588)	500	1x180	UPS12-475	UPS12-475FR
UBCP_270H25MJ	65 - 125	36x28x72 in.	2050 (930)	293	1x180	UPS12-270	UPS12-270FR
UBCP_310H25MJ	65 - 125	36x28x72 in.	2500 (1134)	358	1x180	UPS12-310	UPS12-310FR
UBCP_370H25MJ	65 - 125	36x28x72 in.	2750 (1247)	393	1x180	UPS12-370	UPS12-370FR
UBCP_475H25MJ	65 - 125	36x28x72 in.	3500 (1588)	500	1x180	UPS12-475	UPS12-475FR
UBPP_270H25SJ	100 - 125	36x28x72 in.	2050 (930)	293	1x180	UPS12-270	UPS12-270FR
UBPP_370H25SJ	100 - 125	36x28x72 in.	2750 (1247)	393	1x180	UPS12-370	UPS12-370FR
UBPP_475H25SJ	100 - 125	36x28x72 in.	3500 (1588)	500	1x180	UPS12-475	UPS12-475FR

*An "O" in the 5th digit of the battery cabinet model number signifies standard batteries are being utilized in the battery cabinet. An "F" in the 5th digit of the battery cabinet model number signifies flame retardant batteries are being utilized in the battery cabinet.



Series 300™ UPS

Three Phase

10 kVA to 125 kVA; 60 Hz

Technical Support

U.S.A.	1-800-222-5877
Outside the U.S.A.	614-841-6755
U.K.	+44 (0) 1793 553355
France	+33 1 4 87 51 52
Germany	+49 89 99 19 220
Italy	+39 2 98250 1
Netherlands	+00 31 475 503333
E-mail	upstech@liebert.com
Web site	http://www.liebert.com
Worldwide FAX tech support	614-841-5471

The Company Behind The Products

With more than 500,000 installations around the globe, Liebert is the world leader in computer protection systems. Since its founding in 1965, Liebert has developed a complete range of support and protection systems for sensitive electronics:

- Environmental systems: close-control air conditioning from 1.5 to 60 tons.
- Power conditioning and UPS with power ranges from 250 VA to more than 1000 kVA.
- Integrated systems that provide both environmental and power protection in a single, flexible package.
- Monitoring and control — on-site or remote — from systems of any size or location

Service and support, through more than 100 service centers around the world, and a 24-hour Customer Response Center.

While every precaution has been taken to ensure accuracy and completeness of this literature, Liebert Corporation assumes no responsibility, and disclaims all liability for damages resulting from use of this information or for any errors or omissions.

© 1998 Liebert Corporation. All rights reserved throughout the world. Specifications subject to change without notice.

® Liebert and the Liebert logo are registered trademarks of Liebert Corporation. All names referred to are trademarks or registered trademarks of their respective owners.

Printed in U.S.A.

SL-24535