

SYSTEM OVERVIEW

Preface: This document provides power data and system application information for the following module mounting shelf used in a NetSure™ Power System.

Model	Spec. No.	Description
PSS4850-23GV	588705000	Module Mounting Shelf

For rectifier and converter modules, refer to their separate instruction document as indicated in the following table.

Model	Spec. No.	Description	Document Number
R48-3200	1R483200	Rectifier Module (PCU) (3200 watts)	UM1R483500E
R48-3200e	1R483200E	High Efficiency Rectifier Module (PCU), (3200 watts)	
R48-3500e	1R483500E	High Efficiency Rectifier Module (PCU), (3500 watts)	
C400/48-3500e	1C400483500E	High Efficiency Converter Module (3500 Watts)	UM1C400483500E

Description: A module mounting shelf and rectifier/converter modules, when used in a NetSure Power System equipped with a controller, comprise a -48V DC Power System designed to power a load while charging a positive grounded battery. This system is capable of operating in a battery-less installation or off battery for maintenance purposes. The system is designed for operation with the positive output grounded.

The NetSure Power System utilizing this equipment is an integrated power system containing rectifiers/converters, intelligent control, metering, and monitoring. A NetSure Power System, utilizing this equipment, typically consists of...

- Module Mounting Shelf**
 The system contains one or more module mounting shelves, which houses rectifier/converter modules. A shelf option is available which also houses the NCU Controller.
- Rectifier/Converter Modules**
 The system contains rectifier or converter modules, which provide load power, battery float current, and battery recharge current during normal operating conditions. Refer to the Rectifier Instructions (UM1R483500E) or Converter Instructions (UM1C400483500E) for more information.
- Controller**
 The controller controls the operation of the rectifier and converter modules. The controller also provides power system control, metering, monitoring, and alarm functions. **Note:** This document does not describe the controller. Refer to the Power System SAG (System Application Guide) or separate Controller User Manual for controller information.

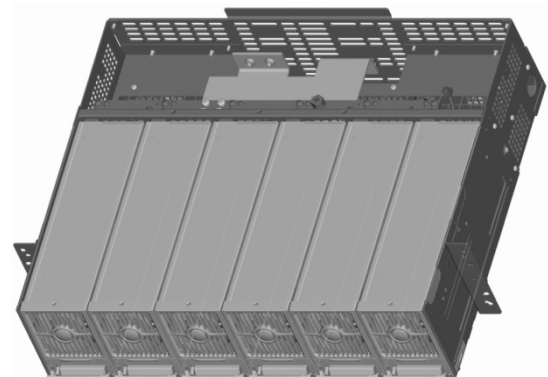

General Specifications

See detailed specifications starting on page 36.

Family:	NetSure™
Shelf Spec. No.:	588705000
Shelf Model:	PSS4850-23GV
Shelf Input Ratings:	<u>List 1, 21, 31, 51, 61</u> : 208 VAC, 240 VAC, 277 VAC, 50/60Hz, 1-Phase, 17.3A/15A. <u>List 11, 22, 53, 63</u> : 208 VAC, 240 VAC, 50/60Hz, 1-Phase, 17.3A/15A. <u>List 3, 32, 52, 62</u> : 208 VAC, 240 VAC, 50/60Hz, 3-Phase, 29.3A/25.5A. <u>List 33</u> : 277/480VAC, 50/60Hz, 3-Phase, 13.5A. <u>List 40, 41</u> : 260VDC to 400VDC, 14.6A. <u>List 42</u> : 260VDC to 400VDC, 44A.
Shelf Output Ratings:	<u>List 1, 3, 11, 21, 22, 31, 32, 33, 40, 41, 42, 51, 52, 53</u> : -48VDC, 437A, 21000W (maximum). <u>List 61, 62, 63</u> : -48VDC, 364A, 17500W (maximum).
Rectifier Input Voltage:	Nominal 208/240 or 277 volts AC, single phase, 50/60 Hz, with an operating range of 176 to 305 volts. Acceptable input frequency range is 45 to 65 Hz.
Rectifier Output Voltage:	-48 Volts DC, nominal.
Rectifier Output Capacity:	
R48-3200 or R48-3200E:	55.2A @ -58.0VDC to 66.6A @ -48.0VDC, 3200 Watts (maximum).
R48-3500E:	60.3A @ -58.0VDC to 72.9A @ -48.0VDC, 3500 Watts (maximum).
Converter Input Voltage:	260VDC to 400VDC.
Converter Output Voltage:	-48 Volts DC, nominal.
Converter Output Capacity:	60.3A @ -58.0VDC to 72.9A @ -48.0VDC, 3500 Watts (maximum).
Agency Approval:	UL 60950 Recognized; CAN/CSA 22.2, No. 60950-00
Framework Type:	For Mounting in a 23 Inch Wide Relay Rack
Mounting Width:	23 Inch (Relay Rack Mounting)
Mounting Depth:	<u>List 1, 3, 11, 21, 22, 31, 32, 33, 40, 41, 42</u> : 17.50 Inches <u>List 51, 52, 53, 61, 62, 63</u> : 18.75 Inches
Mounting Height:	5.25 Inches (3U)
Front Projection:	<u>List 1, 3, 11</u> : Adjustable (flush, 1", 2", 3", 4", 5", or 6"). <u>List 21, 22, 31, 32, 33, 40, 41, 42</u> : Fixed at 9". <u>List 51, 52, 53, 61, 62, 63</u> : Fixed at 6".
Access:	Front and Rear for Installation and Maintenance, Front for Operation
Control:	Microprocessor
Color:	Bright Zinc Plating, Body Textured Gray, Faceplates
Environment:	-40°C to +65°C (-40°F to +149°F)

TABLE OF CONTENTS

SYSTEM OVERVIEW 1

MAIN COMPONENTS ILLUSTRATIONS..... 5

LIST DESCRIPTIONS 6

 List Numbers..... 6

 588705000 List 1: Rectifier Module Mounting Shelf, 208 VAC, 240 VAC, 277 VAC Input, Single-Phase, AC Input Terminal Blocks6

 588705000 List 3: Rectifier Module Mounting Shelf, 208/240VAC Three-Phase Input, AC Input Terminal Blocks6

 588705000 List 11: Rectifier Module Mounting Shelf, 208/240VAC Single-Phase Input, AC Input Line Cords.....7

 588705000 List 21: Rectifier Module Mounting Shelf, 208 VAC, 240 VAC, 277 VAC Input, No AC Input Terminal Blocks7

 588705000 List 22: Rectifier Module Mounting Shelf, 208/240VAC Single-Phase Input, AC Input Line Cords8

 588705000 List 31: Rectifier Module Mounting Shelf, 208 VAC, 240 VAC, 277 VAC Input, Single-Phase, AC Input Terminal Blocks8

 588705000 List 32: Rectifier Module Mounting Shelf, 208/240VAC Three-Phase Input, AC Input Terminal Blocks.....9

 588705000 List 33: Rectifier Module Mounting Shelf, 277/480VAC Three-Phase Input, AC Input Terminal Blocks9

 588705000 List 40: Converter Module Mounting Shelf, 400V DC Input, No DC Input Terminal Blocks10

 588705000 List 41: Converter Module Mounting Shelf, 400V DC Input, DC Input Terminal Blocks10

 588705000 List 42: Converter Module Mounting Shelf, 400V DC Input, DC Input Terminal Blocks11

 588705000 List 51: Expansion Rectifier Module Mounting Shelf, 208 VAC, 240 VAC, 277 VAC Input, Single-Phase, AC Input Terminal Blocks.....11

 588705000 List 52: Expansion Rectifier Module Mounting Shelf, 208/240VAC Three-Phase Input, AC Input Terminal Blocks12

 588705000 List 53: Expansion Rectifier Module Mounting Shelf, 208/240VAC Single-Phase Input, AC Input Line Cords.....12

 588705000 List 61: Main Rectifier Module Mounting Shelf, 208 VAC, 240 VAC, 277 VAC Input, Single-Phase, AC Input Terminal Blocks.....13

 588705000 List 62: Main Rectifier Module Mounting Shelf, 208/240VAC Three-Phase Input, AC Input Terminal Blocks13

 588705000 List 63: Main Rectifier Module Mounting Shelf, 208/240VAC Single-Phase Input, AC Input Line Cords14

ACCESSORY DESCRIPTIONS 15

 Rectifiers 15

 High Efficiency Rectifier Module (PCU), P/N 1R483500E 15

 High Efficiency Rectifier Module (PCU), P/N 1R483200E 15

 Rectifier Module (PCU), P/N 1R483200 15

 Converters..... 16

 High Efficiency DC-DC Converter Module, P/N 1C400483500E..... 16

 NCU Controller (NetSure Control Unit), P/N 1M830DNA 16

 Module Mounting Position Blank Cover Panel..... 16

 Battery Charge Temperature Compensation Components..... 16

 Adding Additional Shelf in Field Output Busbar Kit 17

 User Replaceable Cables 17

 User Replaceable Components..... 17

RECOMMENDED WIRE SIZES, BRANCH CIRCUIT PROTECTION, CRIMP LUGS, AND WIRING ILLUSTRATIONS..... 18

 Shelf Frame Grounding Connection..... 18

 AC Input Connections 18

 List 1, 31, 51, and 61 Module Mounting Shelf (208 VAC, 240 VAC, 277 VAC Input, Single Phase)18

 List 3, 32, 52, and 62 Module Mounting Shelf (208/240VAC Three Phase Input)21

 List 33 Rectifier Shelf (277/480VAC Three Phase Input).....23

 List 11, 22, 53, and 63 Module Mounting Shelf (208/240VAC Single Phase Input).....26

 List 41 Module Mounting Shelf (400V DC Input).....29

 List 42 Module Mounting Shelf (400V DC Input).....31

 DC Output Connections..... 33

 External Alarms Connections 33

SPECIFICATIONS..... 36

 1. Module Mounting Shelf Specifications 36

1.1	Output Ratings.....	36
1.2	Input Ratings.....	36
1.3	Environmental Ratings.....	36
1.4	Compliance Information.....	37
1.5	System Interface Board Ratings (List 61, 62, 63).....	37
1.6	IB2 (Controller Interface Board) Ratings (List 61, 62, 63).....	37
2.	Rectifier Specifications	37
3.	Converter Specifications	37
MECHANICAL SPECIFICATIONS		38
	Overall Dimensions.....	38
	Module Mounting Shelf (List 1, 3, and 11).....	38
	Module Mounting Shelf (List 22, 31, 32, 33, 41, and 42)	39
	Module Mounting Shelf (List 21 and List 40).....	40
	Module Mounting Shelf (61, 62, and 63).....	41
	Module Mounting Shelf (List 51, 52, and 53)	42
RELATED DOCUMENTATION		43
REVISION RECORD		44

MAIN COMPONENTS ILLUSTRATIONS

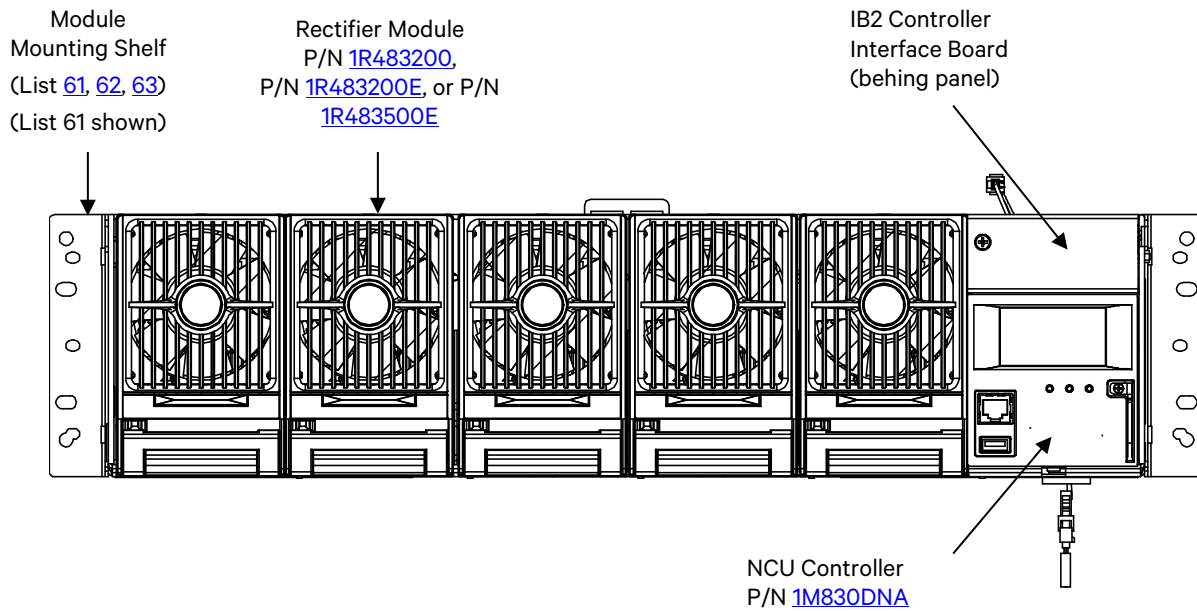
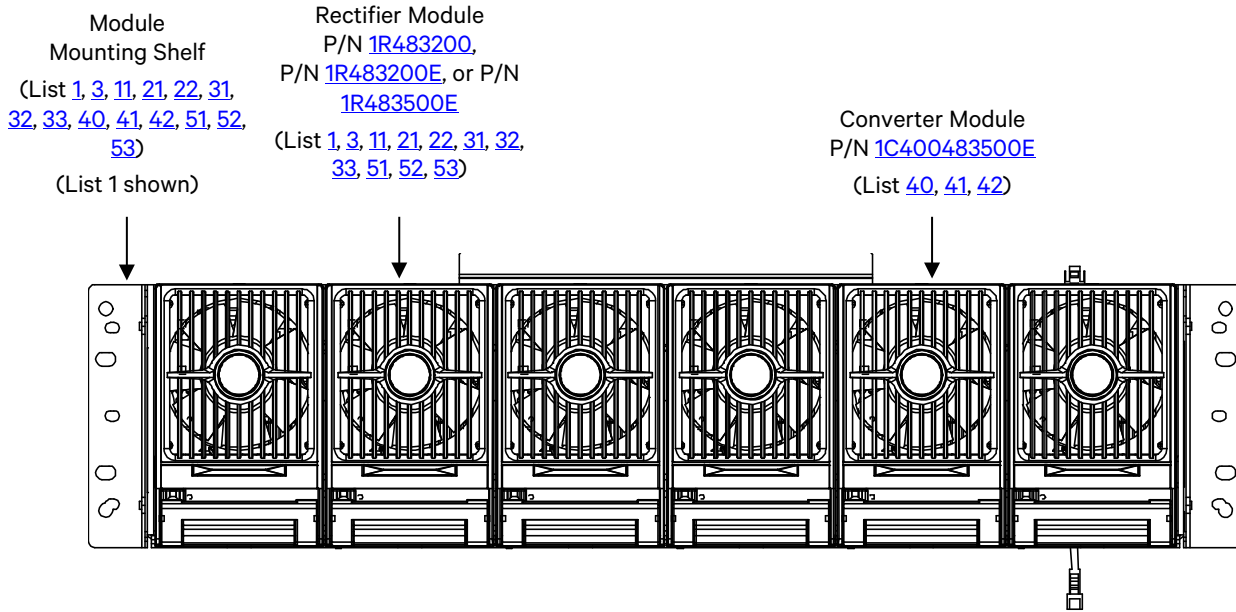

LIST DESCRIPTIONS

List Numbers

588705000 List 1:

Rectifier Module Mounting Shelf, 208 VAC, 240 VAC, 277 VAC Input, Single-Phase, AC Input Terminal Blocks

Features

- ◆ Provides one (1) Model PSS4850-23GV, Spec. No. 588705000 Module Mounting Shelf (-48V, 437A/21000W).
- ◆ This module mounting shelf holds up to six (6) rectifier modules.
- ◆ This module mounting shelf is equipped with individual rectifier module single-phase AC input feeds (One AC input branch circuit per rectifier module, six AC input branch circuits per module mounting shelf).
- ◆ Terminal blocks provided for AC input connections.

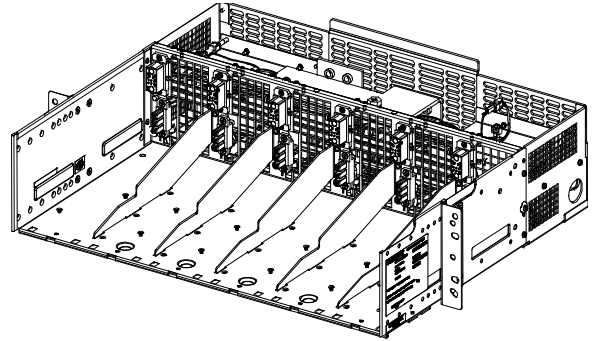

Restrictions

Relay rack mounting angle provides maximum six (6) inch front projection.

Ordering Notes

- 1) Order rectifier modules as required per P/N [1R483200](#), P/N [1R483200E](#), or P/N [1R483500E](#).
- 2) Order a module mounting position blank cover panel, P/N 21140440, for each empty module mounting position in the system, as desired.
- 3) Refer also to "[ACCESSORY DESCRIPTIONS](#)".

588705000 List 3:

Rectifier Module Mounting Shelf, 208/240VAC Three-Phase Input, AC Input Terminal Blocks

Features

- ◆ Provides one (1) Model PSS4850-23GV, Spec. No. 588705000 Module Mounting Shelf (-48V, 437A/21000W).
- ◆ This module mounting shelf holds up to six (6) rectifier modules.
- ◆ This module mounting shelf is equipped with two (2) three-phase AC input circuits. Each input circuit powers three (3) single-phase rectifier modules.
- ◆ Terminal blocks provided for AC input connections.

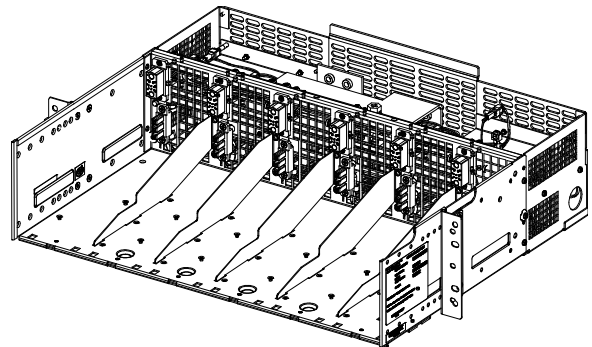

Restrictions

To maintain phase balance, rectifier modules should be installed in groups of three (all three on left and/or all three on right).

Relay rack mounting angle provides maximum six (6) inch front projection.

Ordering Notes

- 1) Order rectifier modules in groups of three per P/N [1R483200](#), P/N [1R483200E](#), or P/N [1R483500E](#).
- 2) Order a module mounting position blank cover panel, P/N 21140440, for each empty module mounting position in the system, as desired.
- 3) Refer also to "[ACCESSORY DESCRIPTIONS](#)".

588705000 List 11:

Rectifier Module Mounting Shelf, 208/240VAC Single-Phase Input, AC Input Line Cords

Features

- ◆ Provides one (1) Model PSS4850-23GV, Spec. No. 588705000 Module Mounting Shelf (-48V, 437A/21000W).
- ◆ This module mounting shelf holds up to six (6) rectifier modules.
- ◆ This module mounting shelf is equipped with individual rectifier module single-phase AC input feeds (one AC input branch circuit per rectifier module, six AC input branch circuits per module mounting shelf).
- ◆ Factory wired AC input line cords equipped with NEMA L6-30P twist-lock plugs provided. (Six per shelf, each 7.5' long, 12/3 AWG.)

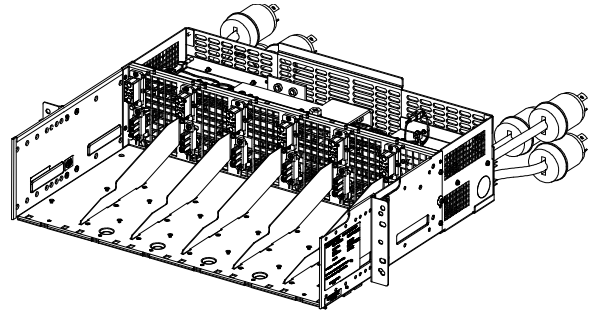

Restrictions

Line cord option can only be used up to 40°C ambient.

Relay rack mounting angle provides maximum six (6) inch front projection.

Ordering Notes

- 1) Order rectifier modules as required per P/N [1R483200](#), P/N [1R483200E](#), or P/N [1R483500E](#).
- 2) Order a module mounting position blank cover panel, P/N 21140440, for each empty module mounting position in the system, as desired.
- 3) Refer also to "[ACCESSORY DESCRIPTIONS](#)".

588705000 List 21:

Rectifier Module Mounting Shelf, 208 VAC, 240 VAC, 277 VAC Input, No AC Input Terminal Blocks

Features

- ◆ Provides one (1) Model PSS4850-23GV, Spec. No. 588705000 Module Mounting Shelf (-48V, 437A/21000W).
- ◆ This module mounting shelf holds up to six (6) rectifier modules.
- ◆ NO terminal blocks provided for AC input connections.

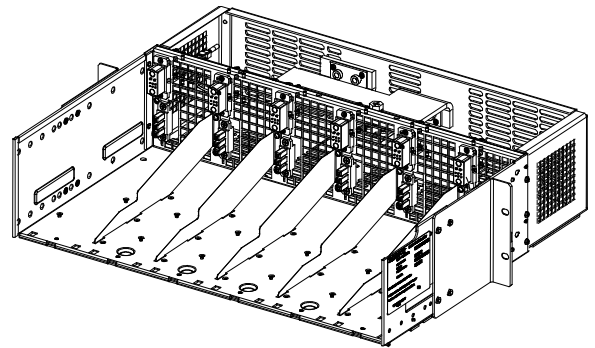

Restrictions

Module mounting shelf MUST be factory wired into power system.

Relay rack mounting angles fixed at 9" front projection.

Ordering Notes

- 1) Order rectifier modules as required per P/N [1R483200](#), P/N [1R483200E](#), or P/N [1R483500E](#).
- 2) Order a module mounting position blank cover panel, P/N 21140440, for each empty module mounting position in the system, as desired.
- 3) Refer also to "[ACCESSORY DESCRIPTIONS](#)".

588705000 List 22:

Rectifier Module Mounting Shelf, 208/240VAC Single-Phase Input, AC Input Line Cords

Features

- ◆ Provides one (1) Model PSS4850-23GV, Spec. No. 588705000 Module Mounting Shelf (-48V, 437A/21000W).
- ◆ This module mounting shelf holds up to six (6) rectifier modules.
- ◆ This module mounting shelf is equipped with individual rectifier module single-phase AC input feeds (one AC input branch circuit per rectifier module, six AC input branch circuits per module mounting shelf).
- ◆ Factory wired AC input line cords equipped with NEMA L6-30P twist-lock plugs provided. (Six per shelf, each 7.5' long, 12/3 AWG.)

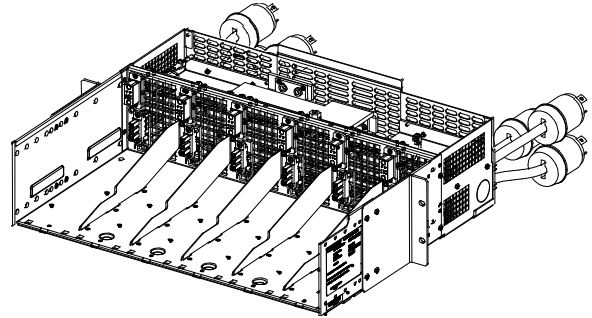

Restrictions

Line cord option can only be used up to 40°C ambient.
Relay rack mounting angles fixed at 9" front projection.

Ordering Notes

- 1) Order rectifier modules as required per P/N [1R483200](#), P/N [1R483200E](#), or P/N [1R483500E](#).
- 2) Order a module mounting position blank cover panel, P/N 21140440, for each empty module mounting position in the system, as desired.
- 3) Refer also to "[ACCESSORY DESCRIPTIONS](#)".

588705000 List 31:

Rectifier Module Mounting Shelf, 208 VAC, 240 VAC, 277 VAC Input, Single-Phase, AC Input Terminal Blocks

Features

- ◆ Provides one (1) Model PSS4850-23GV, Spec. No. 588705000 Module Mounting Shelf (-48V, 437A/21000W).
- ◆ This module mounting shelf holds up to six (6) rectifier modules.
- ◆ This module mounting shelf is equipped with individual rectifier module single-phase AC input feeds (one AC input branch circuit per rectifier module, six AC input branch circuits per module mounting shelf).
- ◆ Terminal blocks provided for AC input connections.

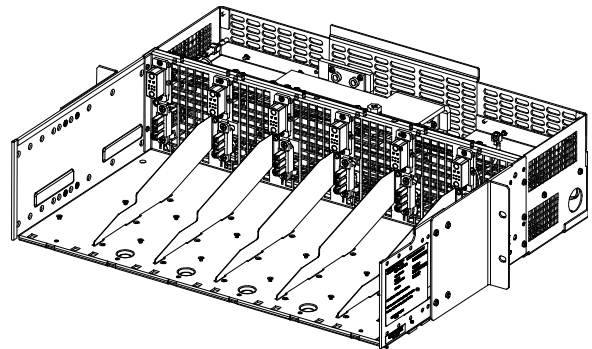

Restrictions

Relay rack mounting angles fixed at 9" front projection.

Ordering Notes

- 1) Order rectifier modules as required per P/N [1R483200](#), P/N [1R483200E](#), or P/N [1R483500E](#).
- 2) Order a module mounting position blank cover panel, P/N 21140440, for each empty module mounting position in the system, as desired.
- 3) Refer also to "[ACCESSORY DESCRIPTIONS](#)".

588705000 List 32:

Rectifier Module Mounting Shelf, 208/240VAC Three-Phase Input, AC Input Terminal Blocks

Features

- ◆ Provides one (1) Model PSS4850-23GV, Spec. No. 588705000 Module Mounting Shelf (-48V, 437A/21000W).
- ◆ This module mounting shelf holds up to six (6) rectifier modules.
- ◆ This module mounting shelf is equipped with two (2) three-phase AC input circuits. Each input circuit powers three (3) single-phase rectifier modules.
- ◆ Terminal blocks provided for AC input connections.

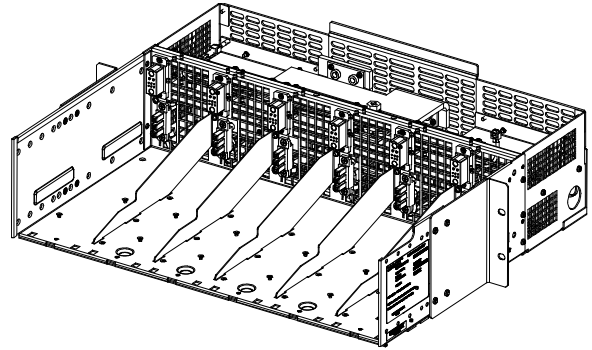

Restrictions

To maintain phase balance, rectifier modules should be installed in groups of three (all three on left and/or all three on right). Relay rack mounting angles fixed at 9" front projection.

Ordering Notes

- 1) Order rectifier modules in groups of three per P/N [1R483200](#), P/N [1R483200E](#), or P/N [1R483500E](#).
- 2) Order a module mounting position blank cover panel, P/N 21140440, for each empty module mounting position in the system, as desired.
- 3) Refer also to "[ACCESSORY DESCRIPTIONS](#)".

588705000 List 33:

Rectifier Module Mounting Shelf, 277/480VAC Three-Phase Input, AC Input Terminal Blocks

Features

- ◆ Provides one (1) Model PSS4850-23GV, Spec. No. 588705000 Module Mounting Shelf (-48V, 437A/21000W).
- ◆ This module mounting shelf holds up to six (6) rectifier modules.
- ◆ This module mounting shelf is equipped with two (2) three-phase AC input circuits. Each input circuit powers three (3) single-phase rectifier modules.
- ◆ Terminal blocks provided for AC input connections.

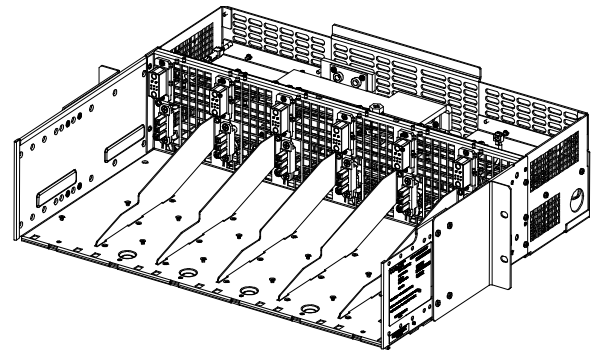

Restrictions

To maintain phase balance, rectifier modules should be installed in groups of three (all three on left and/or all three on right). Relay rack mounting angles fixed at 9" front projection.

Ordering Notes

- 1) Order rectifier module P/N [1R483500E](#) only.
- 2) Order a module mounting position blank cover panel, P/N 21140440, for each empty module mounting position in the system, as desired.
- 3) Refer also to "[ACCESSORY DESCRIPTIONS](#)".

588705000 List 40:

Converter Module Mounting Shelf, 400V DC Input, No DC Input Terminal Blocks

Features

- ◆ Provides one (1) Model PSS4850-23GV, Spec. No. 588705000 Module Mounting Shelf (-48V, 437A/21000W).
- ◆ This module mounting shelf holds up to six (6) converter modules.
- ◆ NO terminal blocks provided for DC input connections.

Restrictions

Module mounting shelf MUST be factory wired into power system.
Relay rack mounting angles fixed at 9" front projection.

Ordering Notes

- 1) Order converter modules as required per P/N [1C400483500E](#).
- 2) Order a module mounting position blank cover panel, P/N 21140440, for each empty module mounting position in the system, as desired.
- 3) Refer also to "[ACCESSORY DESCRIPTIONS](#)".

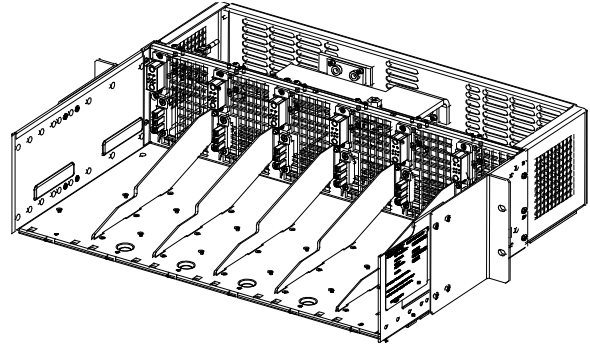

588705000 List 41:

Converter Module Mounting Shelf, 400V DC Input, DC Input Terminal Blocks

Features

- ◆ Provides one (1) Model PSS4850-23GV, Spec. No. 588705000 Module Mounting Shelf (-48V, 437A/21000W).
- ◆ This module mounting shelf holds up to six (6) converter modules.
- ◆ This module mounting shelf is equipped with individual converter module DC input feeds (one DC input branch circuit per converter module, six DC input branch circuits per module mounting shelf).
- ◆ Terminal blocks provided for DC input connections.

Restrictions

DC inputs MUST be wired directly to the shelf.
Relay rack mounting angles fixed at 9" front projection.

Ordering Notes

- 1) Order converter modules as required per P/N [1C400483500E](#).
- 2) Order a module mounting position blank cover panel, P/N 21140440, for each empty module mounting position in the system, as desired.
- 3) Refer also to "[ACCESSORY DESCRIPTIONS](#)".

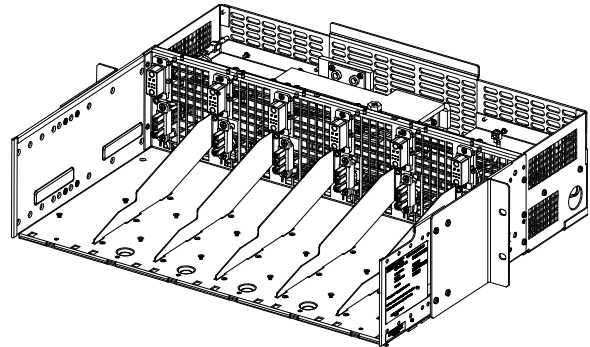

588705000 List 42:

Converter Module Mounting Shelf, 400V DC Input, DC Input Terminal Blocks

Features

- ◆ Provides one (1) Model PSS4850-23GV, Spec. No. 588705000 Module Mounting Shelf (-48V, 437A/21000W).
- ◆ This module mounting shelf holds up to six (6) converter modules.
- ◆ This module mounting shelf is equipped with two (2) DC input circuits. Each input circuit powers three (3) converter modules.
- ◆ Terminal blocks provided for DC input connections.

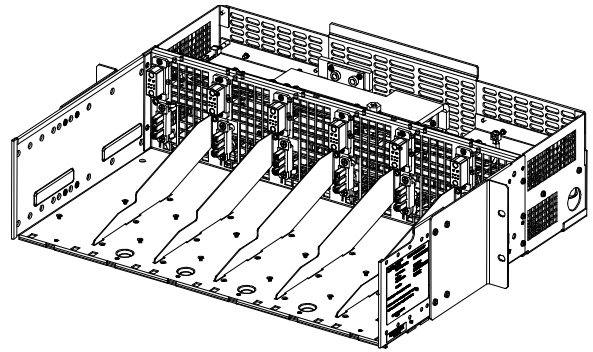

Restrictions

DC inputs MUST be wired directly to the shelf.
Relay rack mounting angles fixed at 9" front projection.

Ordering Notes

- 1) Order converter modules as required per P/N [1C400483500E](#).
- 2) Order a module mounting position blank cover panel, P/N 21140440, for each empty module mounting position in the system, as desired.
- 3) Refer also to "[ACCESSORY DESCRIPTIONS](#)".

588705000 List 51:

Expansion Rectifier Module Mounting Shelf, 208 VAC, 240 VAC, 277 VAC Input, Single-Phase, AC Input Terminal Blocks

Features

- ◆ Provides one (1) Model PSS4850-23GV, Spec. No. 588705000 Module Mounting Shelf (-48V, 437A/21000W).
- ◆ This module mounting shelf holds up to six (6) rectifier modules.
- ◆ This module mounting shelf is equipped with individual rectifier module single-phase AC input feeds (one AC input branch circuit per rectifier module, six AC input branch circuits per module mounting shelf).
- ◆ Terminal blocks provided for AC input connections.

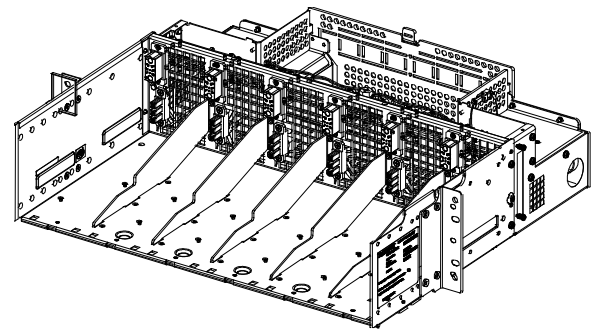

Restrictions

Relay rack mounting angles fixed at 6" front projection.

Ordering Notes

- 1) Order rectifier modules as required per P/N [1R483200](#), P/N [1R483200E](#), or P/N [1R483500E](#).
- 2) Order a module mounting position blank cover panel, P/N 21140440, for each empty module mounting position in the system, as desired.
- 3) Refer also to "[ACCESSORY DESCRIPTIONS](#)".

588705000 List 52:

Expansion Rectifier Module Mounting Shelf, 208/240VAC Three-Phase Input, AC Input Terminal Blocks

Features

- ◆ Provides one (1) Model PSS4850-23GV, Spec. No. 588705000 Module Mounting Shelf (-48V, 437A/21000W).
- ◆ This module mounting shelf holds up to six (6) rectifier modules.
- ◆ This module mounting shelf is equipped with two (2) three-phase AC input circuits. Each input circuit powers three (3) single-phase rectifier modules.
- ◆ Terminal blocks provided for AC input connections.

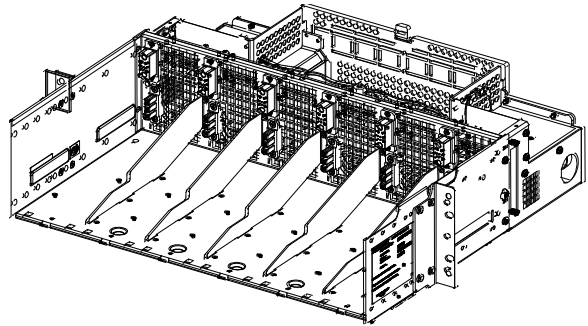

Restrictions

To maintain phase balance, rectifier modules should be installed in groups of three (all three on left and/or all three on right). Relay rack mounting angles fixed at 6" front projection.

Ordering Notes

- 1) Order rectifier modules in groups of three per P/N [1R483200](#), P/N [1R483200E](#), or P/N [1R483500E](#).
- 2) Order a module mounting position blank cover panel, P/N 21140440, for each empty module mounting position in the system, as desired.
- 3) Refer also to "[ACCESSORY DESCRIPTIONS](#)".

588705000 List 53:

Expansion Rectifier Module Mounting Shelf, 208/240VAC Single-Phase Input, AC Input Line Cords

Features

- ◆ Provides one (1) Model PSS4850-23GV, Spec. No. 588705000 Module Mounting Shelf (-48V, 437A/21000W).
- ◆ This module mounting shelf holds up to six (6) rectifier modules.
- ◆ This module mounting shelf is equipped with individual rectifier module single-phase AC input feeds (One AC input branch circuit per rectifier module, six AC input branch circuits per module mounting shelf).
- ◆ Factory wired AC input line cords equipped with NEMA L6-30P twist-lock plugs provided. (Six per shelf, each 7.5' long, 12/3 AWG.)

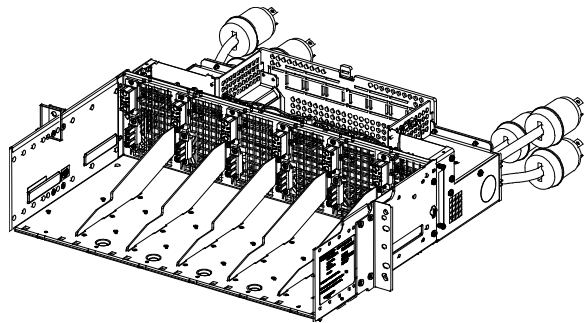

Restrictions

Line cord option can only be used up to 40°C ambient. Relay rack mounting angles fixed at 6" front projection.

Ordering Notes

- 1) Order rectifier modules as required per P/N [1R483200](#), P/N [1R483200E](#), or P/N [1R483500E](#).
- 2) Order a module mounting position blank cover panel, P/N 21140440, for each empty module mounting position in the system, as desired.
- 3) Refer also to "[ACCESSORY DESCRIPTIONS](#)".

588705000 List 61:

Main Rectifier Module Mounting Shelf, 208 VAC, 240 VAC, 277 VAC Input, Single-Phase, AC Input Terminal Blocks

Features

- ◆ Provides one (1) Model PSS4850-23GV, Spec. No. 588705000 Module Mounting Shelf (-48V, 364A/17500W).
- ◆ This module mounting shelf holds up to five (5) rectifier modules and one (1) NCU Controller.
- ◆ This module mounting shelf is equipped with individual rectifier module single-phase AC input feeds (one AC input branch circuit per rectifier module, five AC input branch circuits per module mounting shelf).
- ◆ Terminal blocks provided for AC input connections.
- ◆ Also provided is the system interface board which provides two (2) external battery fuse alarm inputs, four (4) external load fuse alarm inputs, one (1) load shunt input, one (1) battery shunt input, one (1) LVD driver output, one (1) LVD sense input, and RS-485 port.
- ◆ Also provided is the IB2 controller interface board which provides eight (8) programmable form-C relay outputs, eight (8) programmable binary inputs, and two (2) temperature inputs.

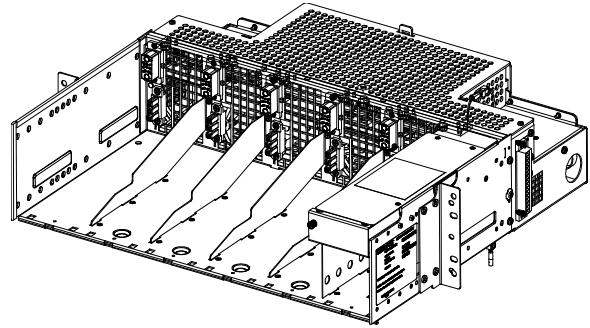

Restrictions

Relay rack mounting angles fixed at 6" front projection.

Ordering Notes

- 1) Order rectifier modules as required per P/N [1R483200](#), P/N [1R483200E](#), or P/N [1R483500E](#).
- 2) Order a module mounting position blank cover panel, P/N 21140440, for each empty module mounting position in the system, as desired.
- 3) Order one (1) NCU controller, P/N [1M830DNA](#).
- 4) Refer also to "[ACCESSORY DESCRIPTIONS](#)".

588705000 List 62:

Main Rectifier Module Mounting Shelf, 208/240VAC Three-Phase Input, AC Input Terminal Blocks

Features

- ◆ Provides one (1) Model PSS4850-23GV, Spec. No. 588705000 Module Mounting Shelf (-48V, 364A/17500W).
- ◆ This module mounting shelf holds up to five (5) rectifier modules and one (1) NCU Controller.
- ◆ This module mounting shelf is equipped with two (2) three-phase AC input circuits. One input powers three (3) single-phase rectifiers (left side) and one input powers two (2) single-phase rectifiers (right side).
- ◆ Terminal blocks provided for AC input connections.
- ◆ Also provided is the system interface board which provides two (2) external battery fuse alarm inputs, four (4) external load fuse alarm inputs, one (1) load shunt input, one (1) battery shunt input, one (1) LVD driver output, one (1) LVD sense input, and RS-485 port.
- ◆ Also provided is the IB2 controller interface board which provides eight (8) programmable form-C relay outputs, eight (8) programmable binary inputs, and two (2) temperature inputs.

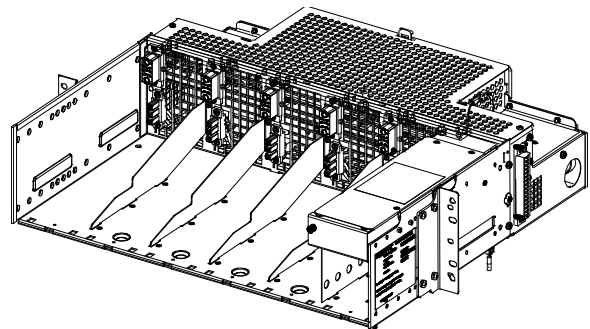

Restrictions

Relay rack mounting angles fixed at 6" front projection.

Ordering Notes

- 1) Order rectifier modules per P/N [1R483200](#), P/N [1R483200E](#), or P/N [1R483500E](#).
- 2) Order a module mounting position blank cover panel, P/N 21140440, for each empty module mounting position in the system, as desired.

- 3) Order one (1) NCU controller, P/N [1M830DNA](#).
- 4) Refer also to "[ACCESSORY DESCRIPTIONS](#)".

588705000 List 63:

Main Rectifier Module Mounting Shelf, 208/240VAC Single-Phase Input, AC Input Line Cords

Features

- ◆ Provides one (1) Model PSS4850-23GV, Spec. No. 588705000 Module Mounting Shelf (-48V, 364A/17500W).
- ◆ This module mounting shelf holds up to five (5) rectifier modules and one (1) NCU Controller.
- ◆ This module mounting shelf is equipped with individual rectifier module single-phase AC input feeds (one AC input branch circuit per rectifier module, five AC input branch circuits per module mounting shelf).
- ◆ Factory wired AC input line cords equipped with NEMA L6-30P twist-lock plugs provided. (Five per shelf, each 7.5' long, 12/3 AWG.)
- ◆ Also provided is the system interface board which provides two (2) external battery fuse alarm inputs, four (4) external load fuse alarm inputs, one (1) load shunt input, one (1) battery shunt input, one (1) LVD driver output, one (1) LVD sense input, and RS-485 port.
- ◆ Also provided is the IB2 controller interface board which provides eight (8) programmable form-C relay outputs, eight (8) programmable binary inputs, and two (2) temperature inputs.

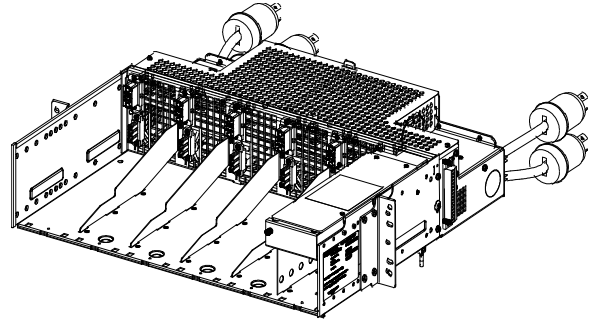

Restrictions

Line cord option can only be used up to 40°C ambient.

Relay rack mounting angles fixed at 6" front projection.

Ordering Notes

- 1) Order rectifier modules as required per P/N [1R483200](#), P/N [1R483200E](#), or P/N [1R483500E](#).
- 2) Order a module mounting position blank cover panel, P/N 21140440, for each empty module mounting position in the system, as desired.
- 3) Order one (1) NCU controller, P/N [1M830DNA](#).
- 4) Refer also to "[ACCESSORY DESCRIPTIONS](#)".

ACCESSORY DESCRIPTIONS

Rectifiers

High Efficiency Rectifier Module (PCU), P/N 1R483500E

Features

- ◆ Provides one (1) Model R48-3500e, Spec. No. 1R483500E, 3500 watt / -48 volt rectifier module.
- ◆ Refer to the Rectifier Instructions (UM1R483500E) for more information.

Restrictions

Refer to the power system's SAG (System Application Guide) for any compatibility issues in using this rectifier in power systems manufactured before this rectifier was available.

For use in List 1, 3, 11, 21, 22, 31, 32, 33, 51, 52, 53, 61, 62, and 63 shelves.

Ordering Notes

- 1) Order as required.

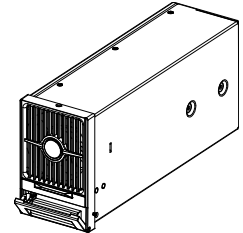

High Efficiency Rectifier Module (PCU), P/N 1R483200E

Features

- ◆ Provides one (1) Model R48-3200e, Spec. No. 1R483200E, 3200 watt / -48 volt rectifier module.
- ◆ Refer to the Rectifier Instructions (UM1R483500E) for more information.

Restrictions

For use in List 1, 3, 11, 21, 22, 31, 32, 51, 52, 53, 61, 62, and 63 shelves.

Ordering Notes

- 1) Order as required.

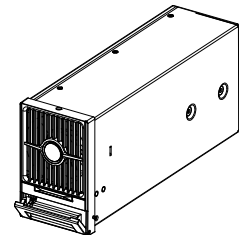

Rectifier Module (PCU), P/N 1R483200

Features

- ◆ Provides one (1) Model R48-3200, Spec. No. 1R483200, 3200 watt / -48 volt rectifier module.
- ◆ Refer to the Rectifier Instructions (UM1R483500E) for more information.

Restrictions

For use in List 1, 3, 11, 21, 22, 31, 32, 51, 52, 53, 61, 62, and 63 shelves.

Ordering Notes

- 1) Order as required.

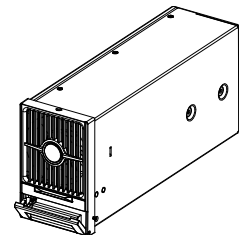

Converters

High Efficiency DC-DC Converter Module, P/N 1C400483500E

Features

- ◆ Provides one (1) Model C400/48-3500e, Spec. No. 1C400483500E, 3500 watt / 400 to -48 volt DC-DC converter module.
- ◆ Refer to the Converter Instructions (UM1C400483500E) for more information.

Restrictions

For use in List 40, 41, and 42 shelves.

Ordering Notes

- 1) Order as required.

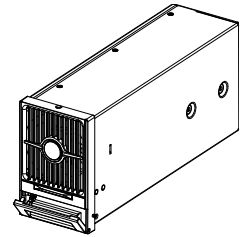

NCU Controller (NetSure Control Unit), P/N 1M830DNA

Features

- ◆ Provides one (1) Model M830DNA, Spec. No. 1M830DNA system controller.
- ◆ Factory programmed with the configuration file required for the system configuration ordered.

Note: For custom NCU configurations, contact Vertiv.

Restrictions

For use in List 61, 62, and 63 only.

Ordering Notes

- 1) Order one (1) NCU Controller (P/N 1M830DNA) per power system (to be installed in a main module mounting shelf List 61, 62, or 63).
- 2) Order additional NCU accessories per the power system's SAG (System Application Guide).

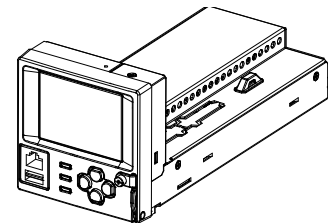

Module Mounting Position Blank Cover Panel

Features

- ◆ Covers one (1) unused module mounting position.

Ordering Notes

- 1) Order a module mounting position blank cover panel, P/N 21140440, for each empty module mounting position in the system, as desired.

Battery Charge Temperature Compensation Components

Ordering Notes

- 1) Refer to the power system's SAG (System Application Guide) for battery charge temperature compensation components.

Adding Additional Shelf in Field Output Busbar Kit

Features

- ◆ Kit to tie the DC output busbars in a field installed module mounting shelf to the DC busbars in a Spec. No. 582126000 or 582127000 NetSure Power System.

Restrictions

Not for use with List 51, 52, 53, 61, 62, or 63.

Ordering Notes

- 1) Order kit P/N 529139 for each module mounting shelf to be added in the field.

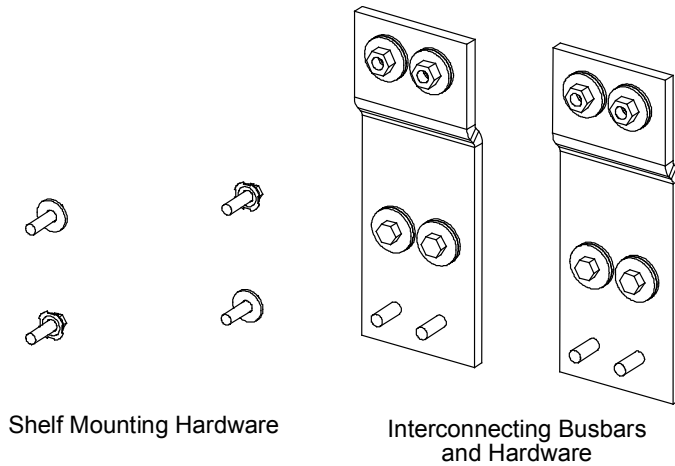

User Replaceable Cables

Ordering Notes

- 1) Refer to the power system's SAG (System Application Guide) for part numbers.

User Replaceable Components

Ordering Notes

- 1) **Rectifier Module Fan:** P/N 32010086 for 1R483200 rectifier module.
P/N 32010109 for 1R483200E and 1R483500E rectifier module.
- 2) **Converter Module Fan:** P/N 32010109 for 1C400483500E converter module.

RECOMMENDED WIRE SIZES, BRANCH CIRCUIT PROTECTION, CRIMP LUGS, AND WIRING ILLUSTRATIONS

Shelf Frame Grounding Connection

Located at the rear of the shelf are terminals for a grounding connection. See Table 1 for recommended frame grounding wire size and Figure 1, Figure 2, Figure 3, Figure 4, Figure 5, Figure 8, or Figure 9 for terminal location.

FRAME GROUND (FR GND) ¹	
Terminals	Recm Wire Size
Two 10-32 X 3/4" Studs and Hardware	10 AWG

- ¹ This terminal must be connected to earth ground, not power system neutral. Equipment grounding conductor size based on recommendations of the NEC Table 250-122 for copper wire. If aluminum or copper clad aluminum grounding conductor is used, refer to Table 250-122 for increased conductor size. For operation in countries where the NEC is not recognized, follow applicable codes.
- ² For shelf grounding requirements, refer to the current edition of the American National Standards Institute (ANSI) approved National Fire Protection Association's (NFPA) National Electrical Code (NEC), applicable local codes, and your specific site requirements.

Table 1
Recommended Frame Grounding Wire Size

AC Input Connections

List 1, 31, 51, and 61 Module Mounting Shelf (208 VAC, 240 VAC, 277 VAC Input, Single Phase)

Refer to Table 2 for recommended wire size and Figure 1 or Figure 2 for terminal location.

LIST 1, 31, 51, AND 61 AC INPUT (TB1 and TB2) Connection Points for Individual Rectifier Module AC Input Branch Circuits are Provided (One AC Input Branch Circuit per Rectifier Module, Five [List 61] or Six [List 1, 31, 51] AC Input Branch Circuits per Shelf)				
Operating Ambient Temperature ¹	Recm Branch Circuit Protection ^{2,3}	Recm 90°C Wire Size ¹	TB1 and TB2 Terminals	
			Capacity	Type
30°C	25 Amperes	10 AWG	List 1, 31: 10 to 24 AWG List 51, 61: 6 to 14 AWG	Screw Compression Tubular Contact
40°C				
65°C				

- ¹ Wire sizes based on recommendations of the American National Standards Institute (ANSI) approved National Fire Protection Association's (NFPA) National Electrical Code (NEC). Table 310.15 (B) (16) for copper wire at 90°C conductor temperature. For operation in countries where the NEC is not recognized, follow applicable codes.
- ² The AC input branch circuit protective device should be of the time-delay or high inrush type.
- ³ Recommendations based on Nominal Line Full Load Input Current of 18 Amperes.

Table 2
Recommended AC Input Branch Circuit Protection and Wire Size - List 1, 31, 51, and 61

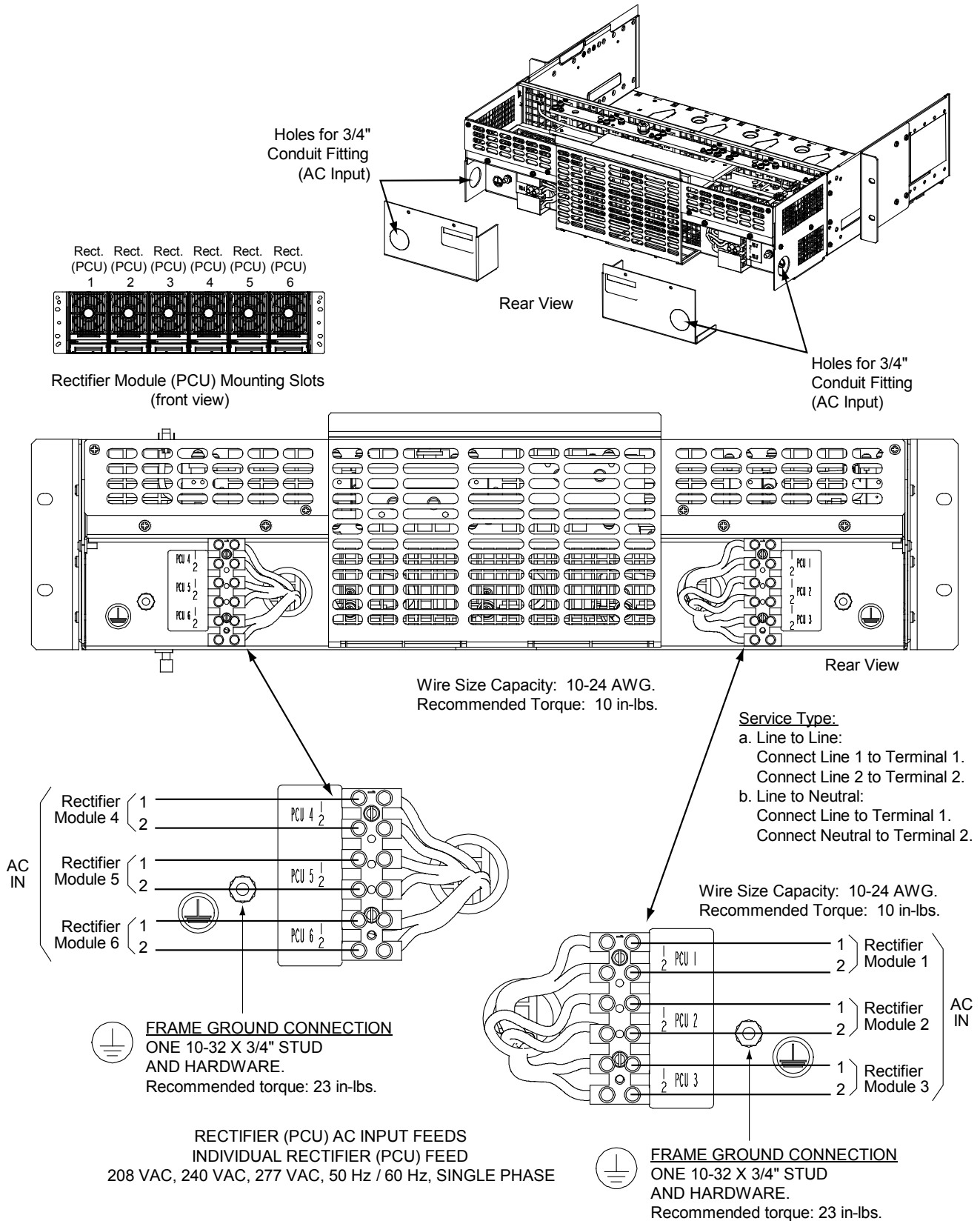

Figure 1
 List 1 and 31 AC Input and Frame Ground Connections (Single-Phase Input) (Terminal Blocks)

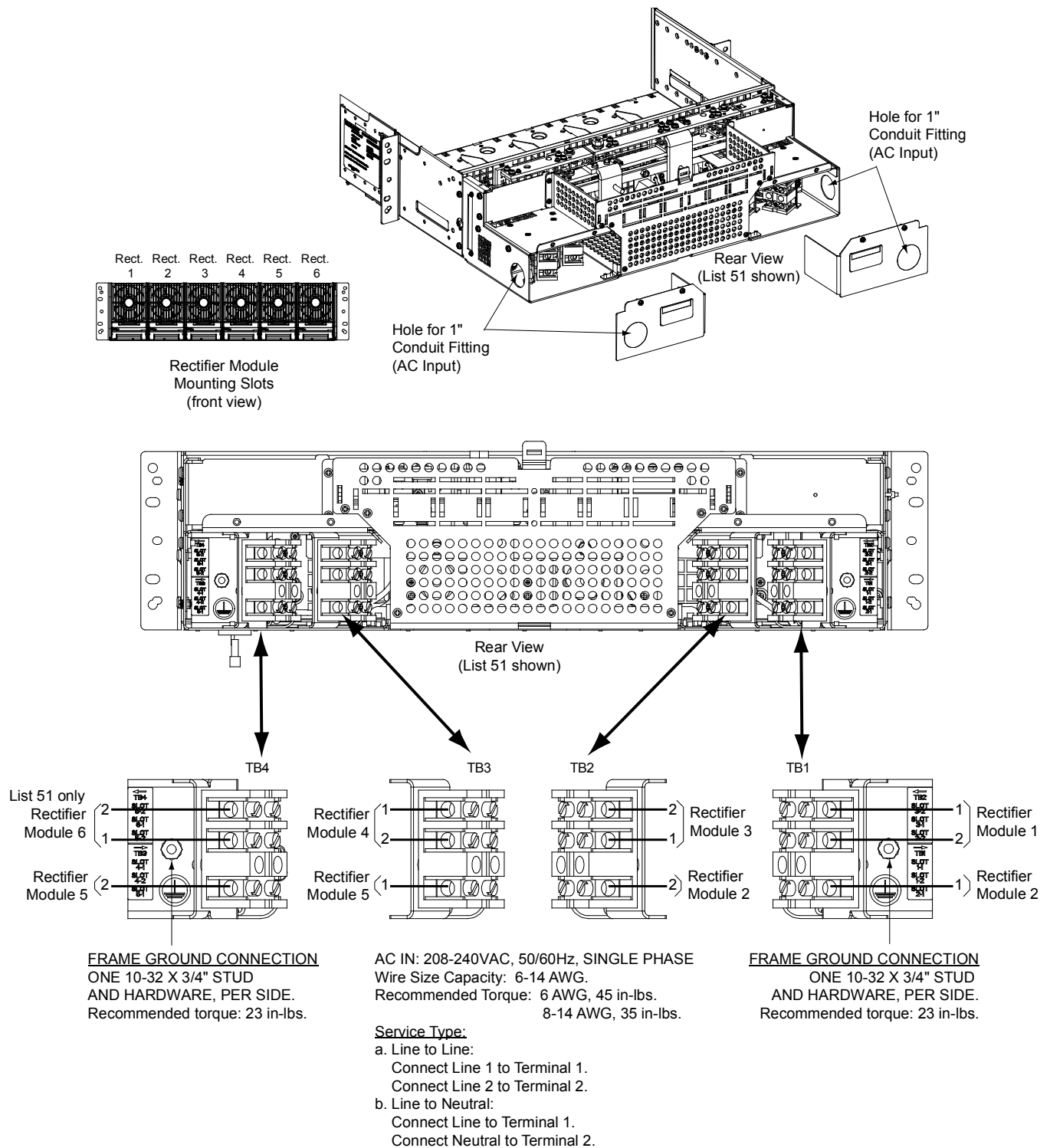

Figure 2
List 51 and 61 AC Input and Frame Ground Connections (Single-Phase Input) (Terminal Blocks)

[Home](#)

List 3, 32, 52, and 62 Module Mounting Shelf (208/240VAC Three Phase Input)

Refer to Table 3 for recommended wire size and Figure 3 or Figure 5 for terminal location.

LIST 3, 32, 52, AND 62 AC INPUT (TB1 and TB2)				
Connection Points for Two 3-Phase AC Input Feeds are Provided per Shelf				
Operating Ambient Temperature¹	Recm Branch Circuit Protection^{2,3}	Recm 90°C Wire Size¹	TB1 and TB2 Terminals	
			Capacity	Type
30°C	40 Amperes, 3-Pole	8 AWG	6 to 14 AWG	Screw Compression Tubular Contact
40°C				
65°C				

- ¹ Wire sizes based on recommendations of the American National Standards Institute (ANSI) approved National Fire Protection Association's (NFPA) National Electrical Code (NEC). Table 310.15 (B) (16) for copper wire at 90°C conductor temperature. For operation in countries where the NEC is not recognized, follow applicable codes.
- ² The AC input branch circuit protective device should be of the time-delay or high inrush type.
- ³ Recommendations based on Nominal Line Full Load Input Current of 29.3 Amperes.

Table 3
 Recommended AC Input Branch Circuit Protection and Wire Size - List 3, 32, 52, and 62

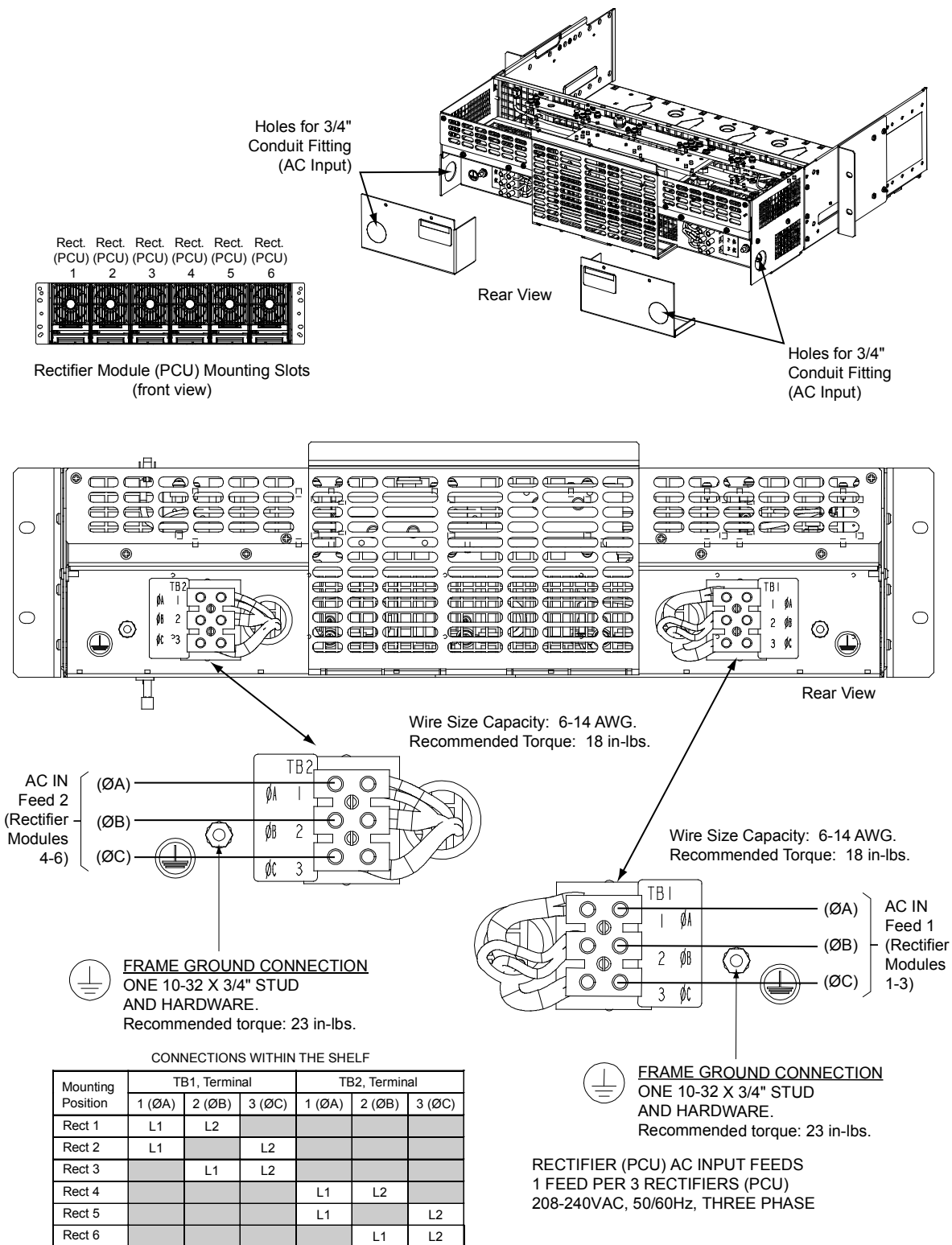

Figure 3
List 3 and 32 AC Input and Frame Ground Connections (Three-Phase Input) (Terminal Blocks)

[Home](#)

List 33 Rectifier Shelf (277/480VAC Three Phase Input)

Refer to Table 4 for recommended wire size and Figure 4 for terminal location.

LIST 33 AC Input (TB1 and TB2)				
Operating Ambient Temperature ¹	Recm Branch Circuit Protection ^{2,3}	Recommended 90°C Wire Size ¹	TB1 and TB2 Terminals	
			Capacity	Type
30°C	20A	12 AWG	8 to 24 AWG	Screw Compression Tubular Contact
40°C				
65°C				

- ¹ Wire sizes based on recommendations of the American National Standards Institute (ANSI) approved National Fire Protection Association's (NFPA) National Electrical Code (NEC). Table 310.15 (B) (16) for copper wire at 90°C conductor temperature. For operation in countries where the NEC is not recognized, follow applicable codes.
- ² The AC input branch circuit protective device should be of the time-delay or high inrush type.
- ³ Recommendations based on Nominal Line Full Load Input Current of 13.5 Amperes.

Table 4
 Recommended AC Input Branch Circuit Protection and Wire Size - List 33

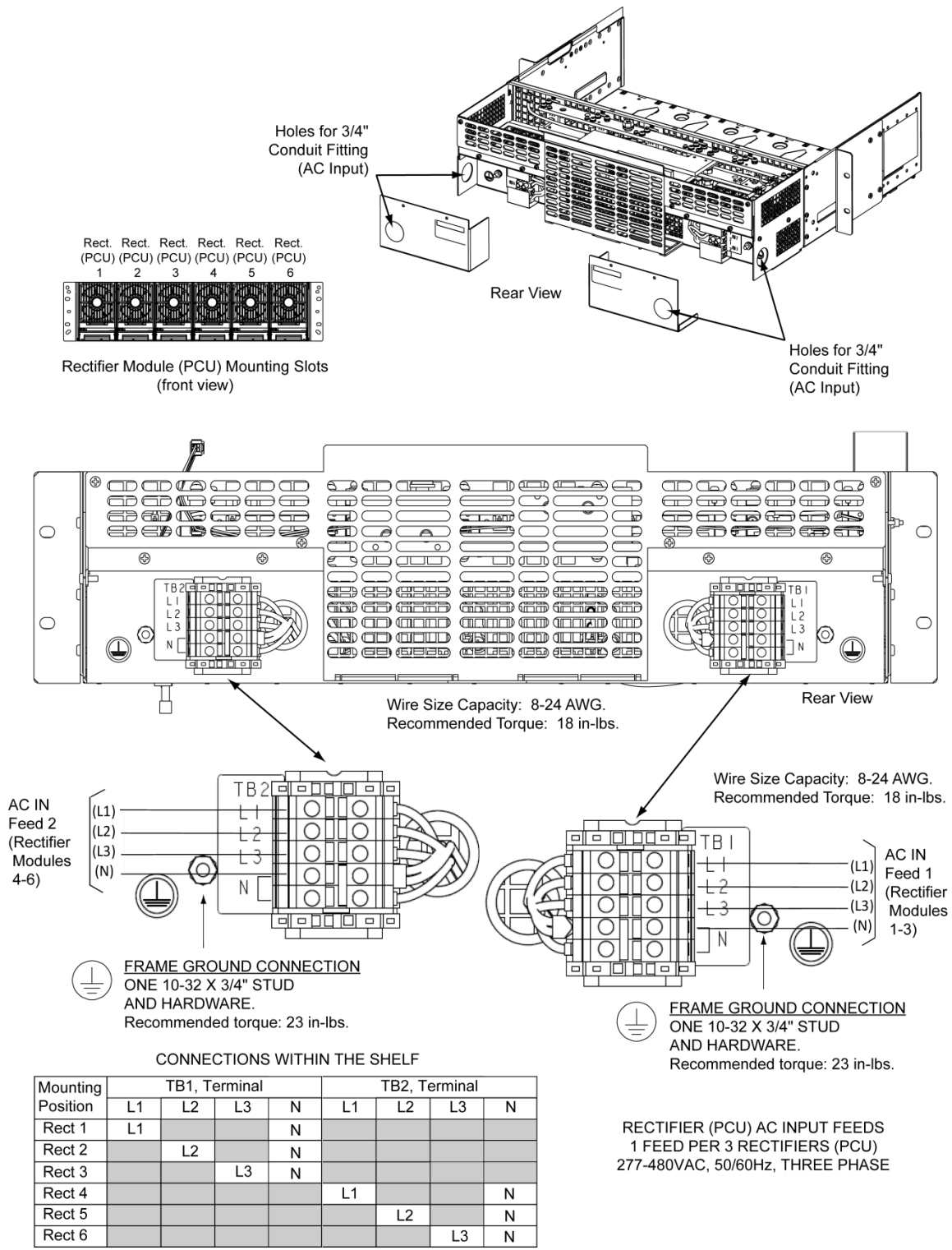
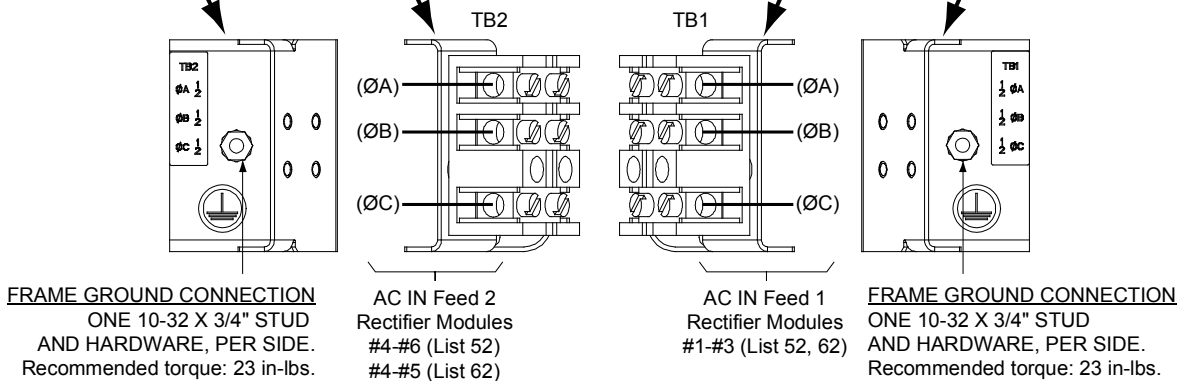
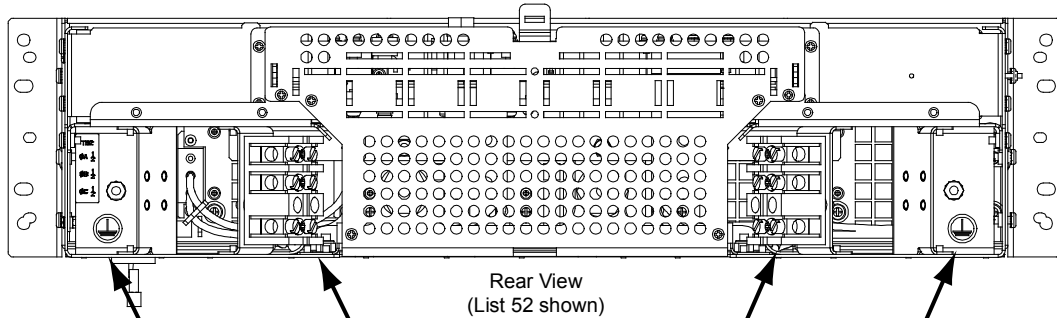
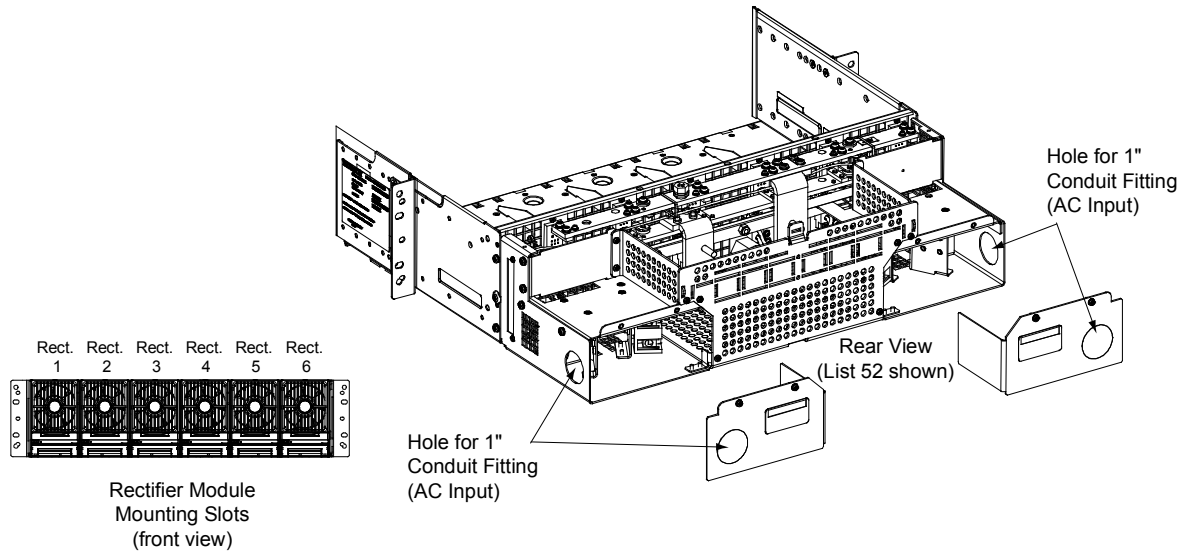

Figure 4
List 33 AC Input and Frame Ground Connections (Three-Phase Input) (Terminal Blocks)



CONNECTIONS WITHIN THE SHELF

Mounting Position	TB1, Terminal			TB2, Terminal		
	1 (ØA)	2 (ØB)	3 (ØC)	1 (ØA)	2 (ØB)	3 (ØC)
Rect 1	L1	L2				
Rect 2	L1		L2			
Rect 3		L1	L2			
Rect 4				L1	L2	
Rect 5				L1		L2
Rect 6				L1	L2	

AC IN: 208-240VAC, 50/60Hz, THREE PHASE
 Wire Size Capacity: 6-14 AWG.
 Recommended Torque: 6 AWG, 45 in-lbs.
 8-14 AWG, 35 in-lbs.

List 52 only

Figure 5
 List 52 and 62 AC Input and Frame Ground Connections (Three-Phase Input) (Terminal Blocks)

[Home](#)

List 11, 22, 53, and 63 Module Mounting Shelf (208/240VAC Single Phase Input)

Refer to Table 5 for recommended wire size and Figure 6 or Figure 7 for terminal location.

LIST 11, 22, 53, AND 63 AC INPUT (Line Cords) Line Cords for Individual Rectifier Module AC Input Branch Circuits are Factory Connected (One AC Input Branch Circuit per Rectifier Module, Five [List 63] or Six [List 11, 22, 53] AC Input Branch Circuits per Shelf)	
Operating Ambient Temperature	Recm Branch Circuit Protection ^{1,2}
30°C	25 Amperes
40°C ³	

- ¹ The AC input branch circuit protective device should be of the time-delay or high inrush type.
- ² Recommendations based on Nominal Line Full Load Input Current of 18 Amperes.
- ³ Line cord option can only be used up to 40°C ambient.

Table 5
 Recommended AC Input Branch Circuit Protection and Wire Size - List 11, 22, 53, and 63

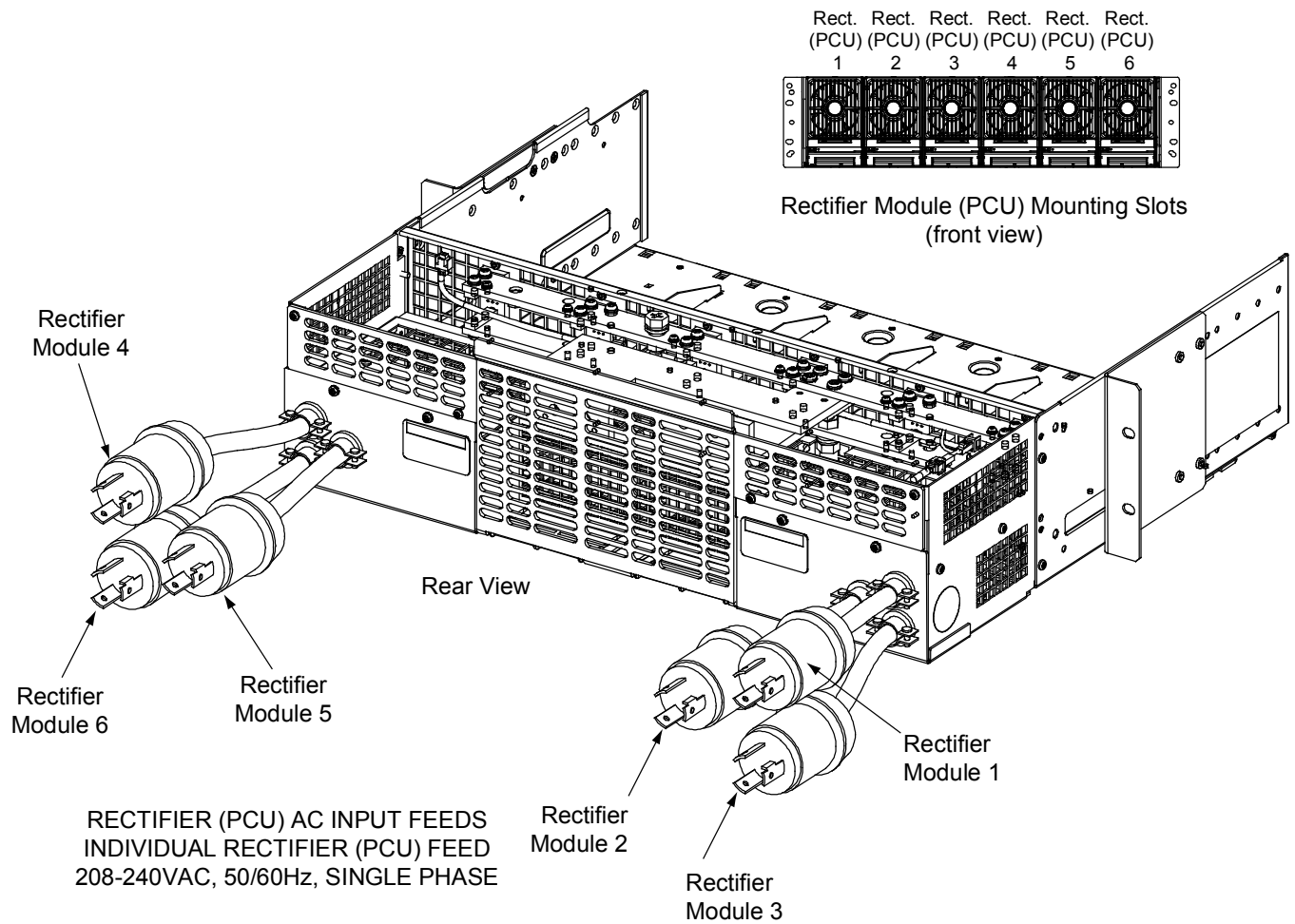

Figure 6
 List 11 and 22 AC Input Connections (Single-Phase Input) (Line Cords)

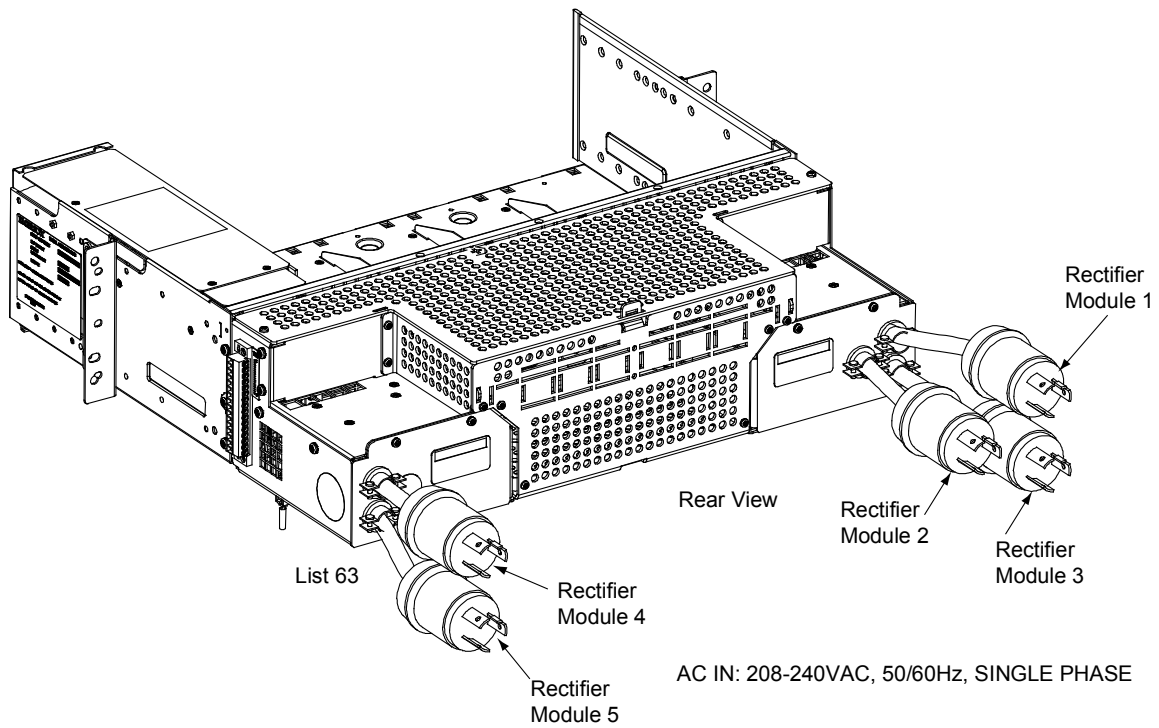
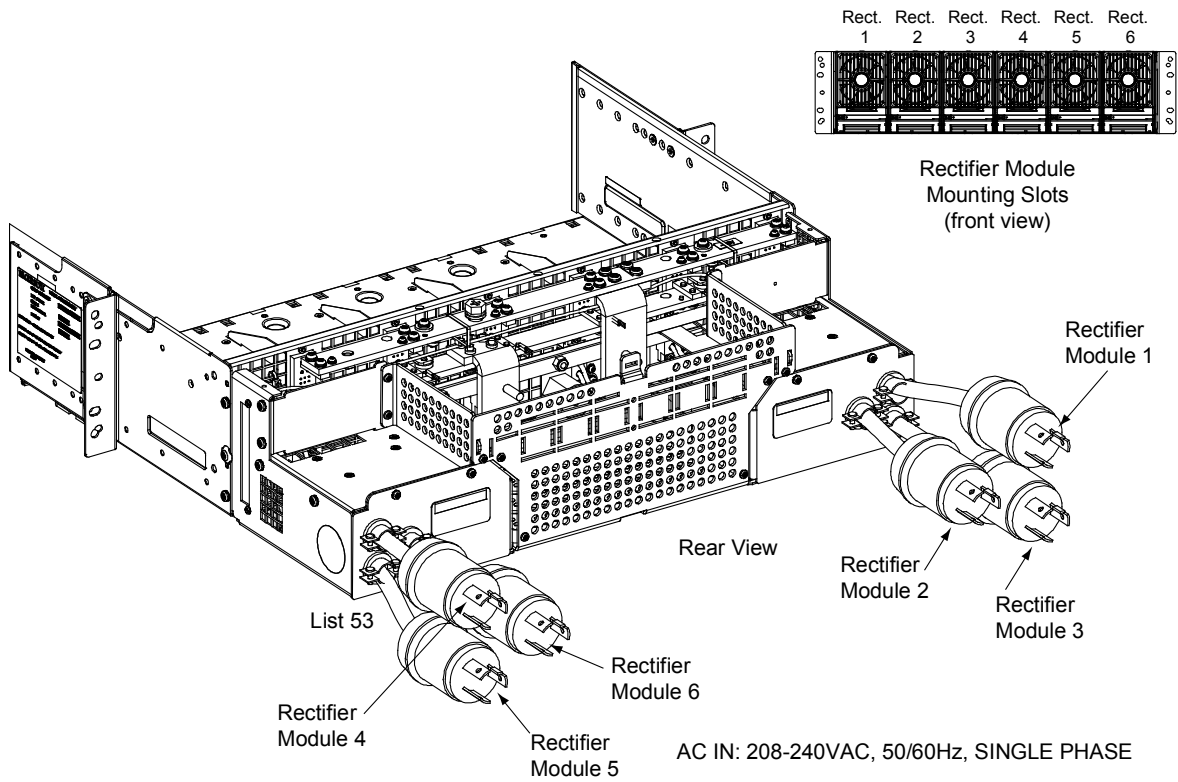

Figure 7
 List 53 and 63 AC Input Connections (Single-Phase Input) (Line Cords)

[Home](#)

List 41 Module Mounting Shelf (400V DC Input)

Refer to Table 6 for recommended wire size and Figure 8 for terminal location.

LIST 41 DC INPUT (TB1 and TB2) Connection Points for Individual Rectifier Module DC Input Branch Circuits are Provided (One DC Input Branch Circuit per Rectifier Module, Six DC Input Branch Circuits per Shelf)				
Operating Ambient Temperature¹	Recm Branch Circuit Protection³	Recm 90°C Wire Size^{1, 4}	TB1 and TB2 Terminals	
			Capacity	Type
45°C	20 Amperes	12 AWG	10 to 20 AWG	Screw Compression Tubular Contact
50°C				
65°C ²				

- ¹ Wire sizes based on recommendations of the American National Standards Institute (ANSI) approved National Fire Protection Association's (NFPA) National Electrical Code (NEC). Table 310.15 (B) (16) for copper wire at 90°C conductor temperature. For operation in countries where the NEC is not recognized, follow applicable codes.
- ² Converters de-rate to 2700W at an ambient of 65°C.
- ³ Recommendations based on Full Load Input Current of 14.6 Amperes.
- ⁴ Maximum loop length is 100 meters (328 feet). Loop length is the sum of the lengths of the positive and negative leads.

Table 6
 Recommended DC Input Branch Circuit Protection and Wire Size - List 41

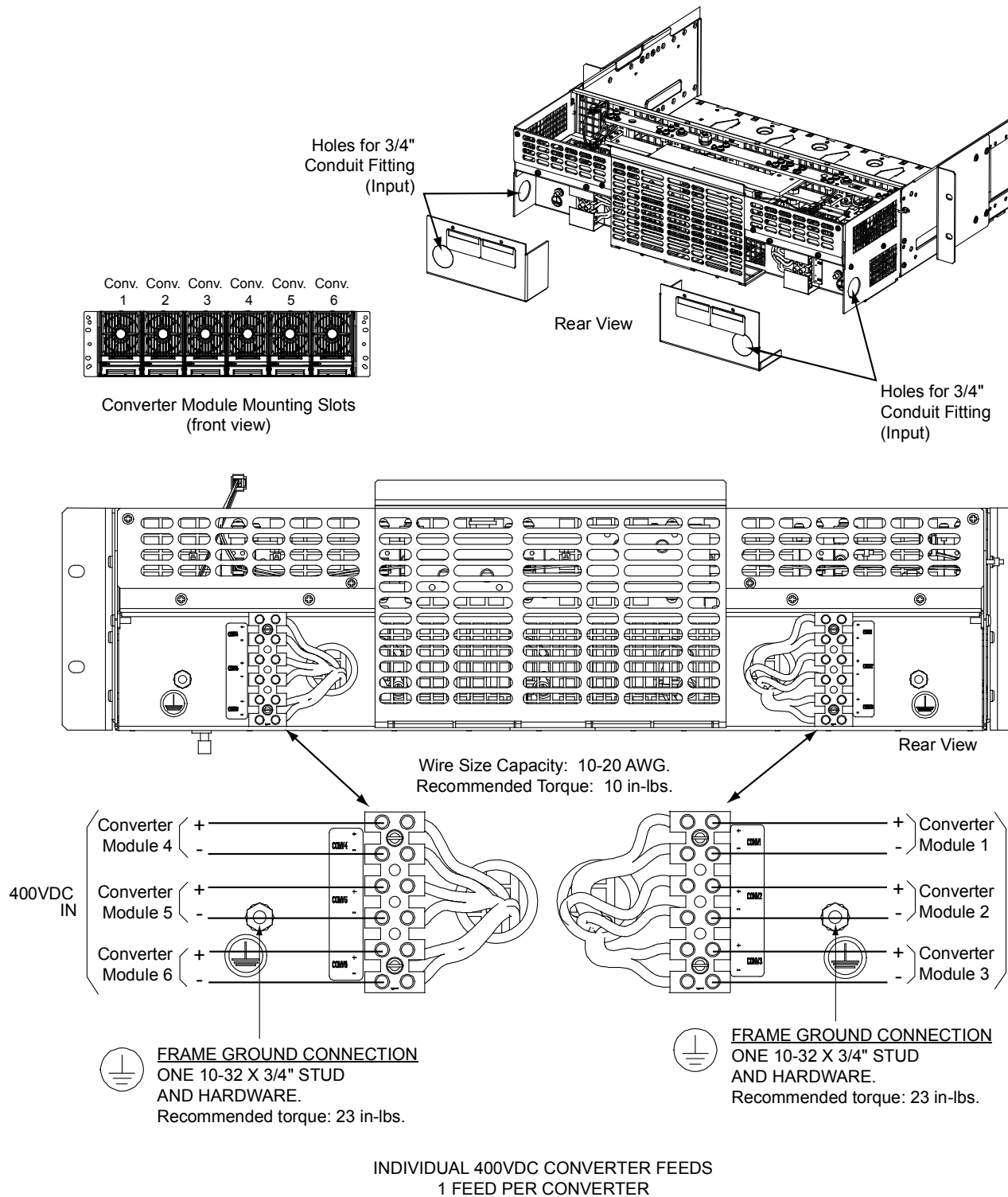

Figure 8
List 41 DC Input and Frame Ground Connections (Terminal Blocks)

[Home](#)

List 42 Module Mounting Shelf (400V DC Input)

Refer to Table 7 for recommended wire size and Figure 9 for terminal location.

LIST 42 DC INPUT (TB1 and TB2)				
Connection Points for Two DC Input Feeds are Provided per Shelf				
Operating Ambient Temperature¹	Recm Branch Circuit Protection^{3, 4}	Recm 90°C Wire Size^{1, 5}	TB1 and TB2 Terminals	
			Capacity	Type
45°C	60 Amperes	6 AWG	6 to 14 AWG	Screw Compression Tubular Contact
50°C				
65°C ²				

¹ Wire sizes based on recommendations of the American National Standards Institute (ANSI) approved National Fire Protection Association's (NFPA) National Electrical Code (NEC). Table 310.15 (B) (16) for copper wire at 90°C conductor temperature. For operation in countries where the NEC is not recognized, follow applicable codes.

² Converters de-rate to 2700W at an ambient of 65°C.

³ Recommendations based on Full Load Input Current of 44 Amperes.

⁴ Maximum overcurrent protective device is 70A at 40°C.

⁵ Maximum loop length is 100 meters (328 feet). Loop length is the sum of the lengths of the positive and negative leads.

Table 7
 Recommended DC Input Branch Circuit Protection and Wire Size - List 42

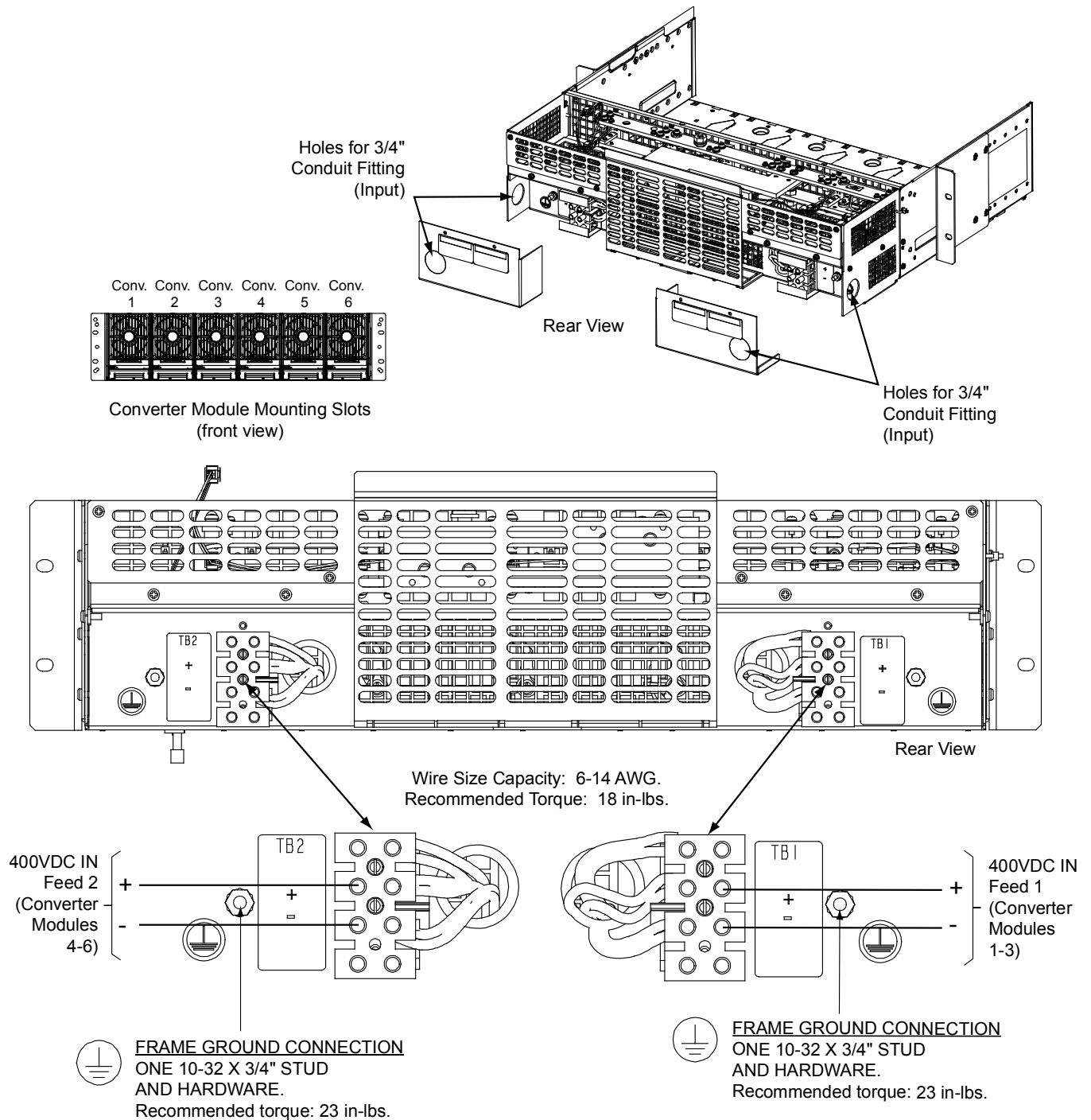

CONVERTER 400VDC INPUT FEEDS
1 FEED PER 3 CONVERTERS

Figure 9
List 42 DC Input and Frame Ground Connections (Terminal Blocks)

[Home](#)

DC Output Connections

Shelf DC output is connected via busbars to a NetSure Power System. No wire size or lug recommendations provided here. Refer to Figure 10 and Figure 11.

External Alarms Connections

Shelf external alarms are provided via the Controller. Refer to the associated power system documentation for external alarm information. No wire size recommendations provided here. Refer to Figure 10 and Figure 11 for controller interconnections.

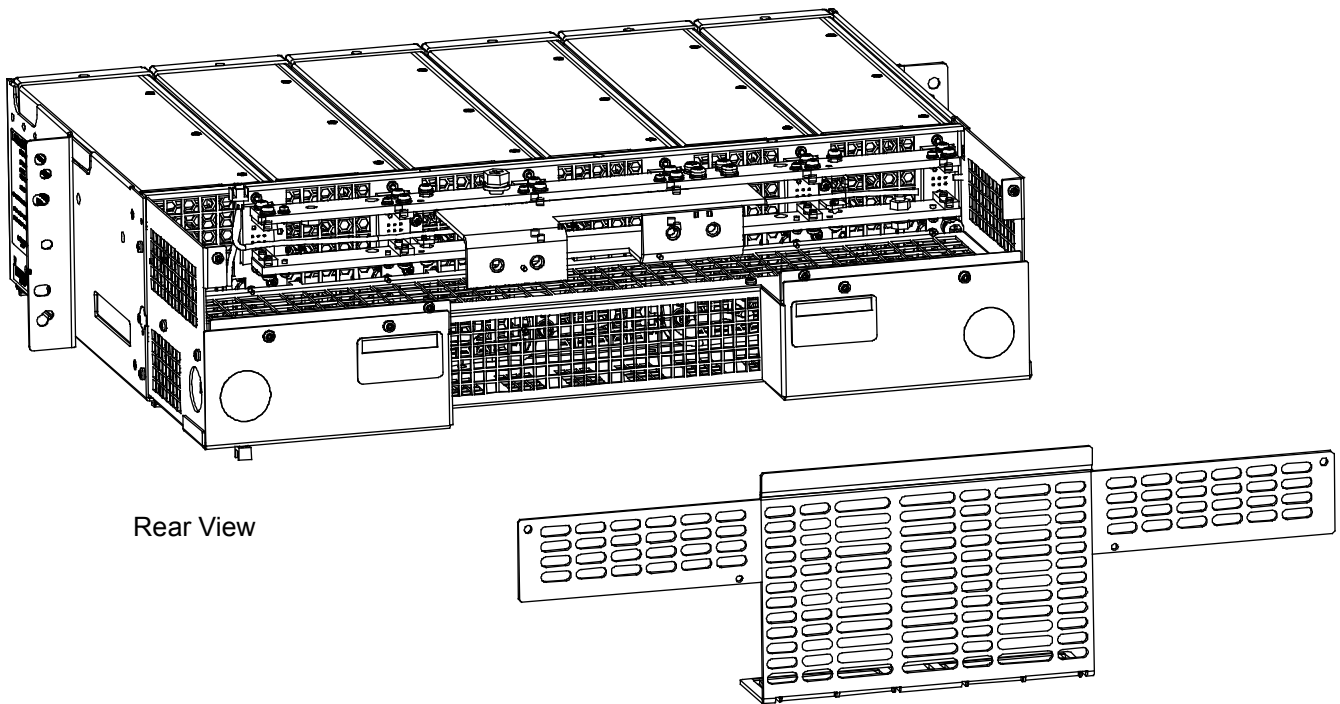

Alarm & Control
 Connections Between
 Shelves and Controller

to Controller if Top Shelf
 or
 to Shelf Mounted Above

1/4-20 Captive Fastener
 (4 Places, 2 per Polarity)

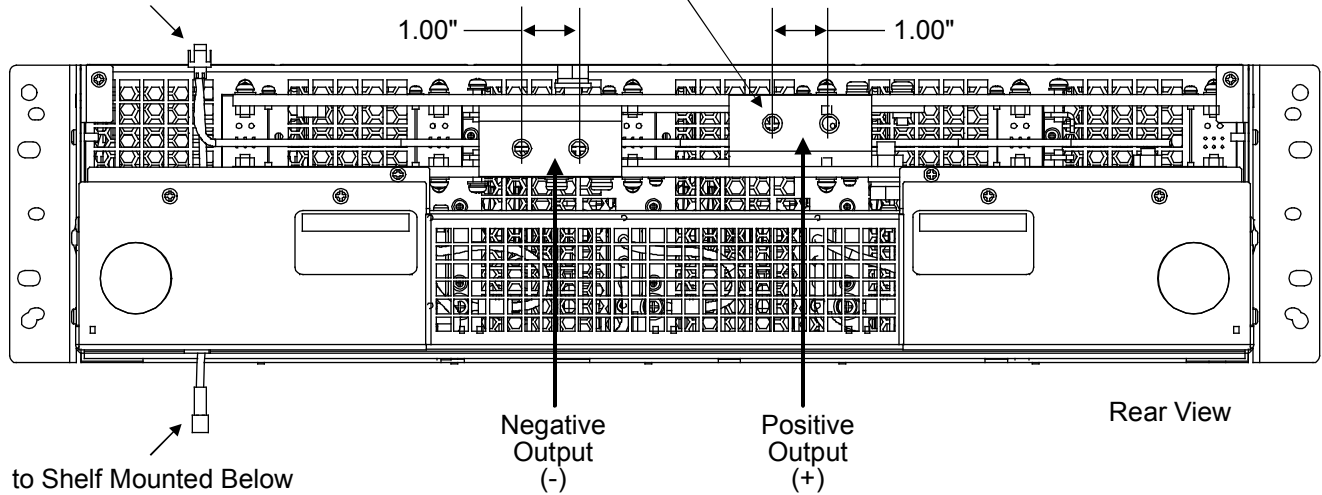

Alarm & Control
 Connections Between
 Shelves and Controller

Figure 10
 DC Output and Alarm/Control Connections
 (List 1, 3, 11, 21, 22, 31, 32, 40, 41, 42)

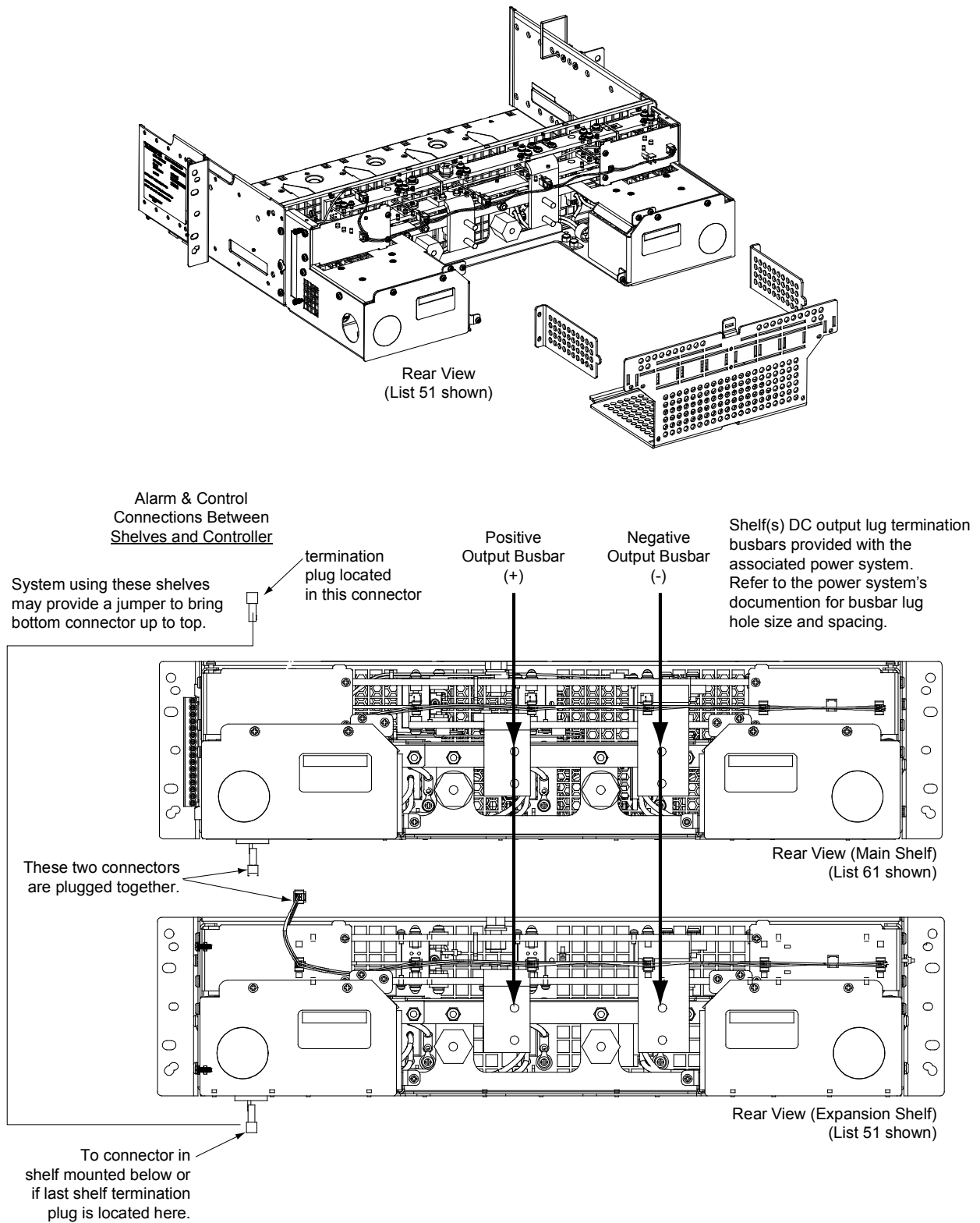

Figure 11
 DC Output and Alarm/Control Connections
 (List 51, 52, 53, 61, 62, 63)

SPECIFICATIONS

Note: Refer to the separate System Application Guide (SAG) of the associated Power System for the following:

- MCA Controller specifications and factory default settings.
- NCU Controller specifications and factory default settings.
- All external alarms.
- All external controls.
- Local status and alarm indicators other than those provided on the rectifier and converter modules.

1. MODULE MOUNTING SHELF SPECIFICATIONS

1.1 Output Ratings

1.1.1 See page 2.

1.2 Input Ratings

1.2.1 See page 2.

1.3 Environmental Ratings

1.3.1 **Operating Ambient Temperature Range:** -40°C to +65°C (-40°F to +149°F).

1.3.2 **Storage Ambient Temperature Range:** -40°C to +85°C (-40°F to +185°F).

1.3.3 **Humidity:** Capable of operating in an ambient relative humidity range of 0% to 95%, non-condensing.

1.3.4 **Altitude:** Capable of operating in an altitude range of -200 feet to 10,000 feet. The maximum operating ambient temperature should be de-rated by 3°C per 1000 feet above 5000 feet.

1.3.5 Ventilation Requirements:

(A) **Ventilation:** A module mounting shelf must be mounted so ventilating openings are not blocked and temperature of the air entering the cabinet does not exceed the Operating Ambient Temperature Range stated above. The distance from the rear of a module mounting shelf to a wall or other solid structure must not be less than two (2) inches. This will assure proper airflow through the rectifier modules. (See also Paragraph 1.3.6.)

(B) **Stacking Considerations:** This system is designed for front to back ventilation to facilitate stacking of module mounting shelves, one above the other, in a relay rack. There is no spacing requirement between stacked module mounting shelves of a single system.

1.3.6 **Mounting:** The module mounting shelves are designed for mounting in a 23 inch wide relay rack with 1 inch or 1-3/4 inch multiple drilling. For Lists 1, 3, and 11; mounting angles can be positioned from flush-front mounting to 6-inch front projection mounting, in 1-inch increments. For Lists 21, 22, 31, 32, 33, 40, 41, and 42; mounting angles are positioned for a fixed 9-inch front projection mounting. For Lists 51, 52, 53, 61, 62, and 63; mounting angles are positioned for a fixed 6-inch front projection mounting. Refer to Overall Dimensions starting on page 38 for dimensional illustrations.

- This product is intended only for installation in a restricted access location on or above a non-combustible surface.
- This product must be located in a controlled environment with access to crafts persons only.
- This product is intended for installation in network telecommunication facilities (CO, vault, hut, or other environmentally controlled electronic equipment enclosure).
- This product is intended to be connected to the common bonding network in a network telecommunication facility (CO, vault, hut, or other environmentally controlled electronic equipment enclosure).
- The DC return connection to this system can remain isolated from system frame and chassis (DC-I).
- This system is suitable for installation as part of the Common Bonding Network (CBN).
- Rectifier and module mounting shelf ventilating openings must not be blocked and temperature of air entering rectifiers must not exceed the rated operating ambient temperature range.
- Clearance requirements are:
 - a) Recommended minimum aisle space clearance for the front of the unit is 2' 6".
 - b) See Paragraph 1.3.5 for minimum rear spacing requirements.

Note: Minimum rear spacing specified for ventilation may not permit installation and maintenance of the system.

[Home](#)

Recommended minimum aisle space clearance for the rear of each bay is 2' 0" to allow for installation and maintenance.

1.4 Compliance Information

1.4.1 **Safety Compliance:** This unit meets the requirements of UL 60950-1, Standard for Information Technology Equipment, and is UL Recognized as a power supply for use in Telephone, Electronic Data Processing or Information Processing Equipment. This unit meets the requirements of CAN/CSA 22.2, No. 60950-00 and is tested and Certified by UL ("c UR") as a Component Type Power Supply.

1.5 System Interface Board Ratings (List 61, 62, 63)

1.5.1 **Battery Fuse Alarm Input Rating**

(A) The default is 400mV. Anything greater than 400mV causes alarm to be raised.

1.5.2 **Load Fuse Alarm Input Signal**

(A) Anything greater than 19V causes alarm to be raised.

1.5.3 **Battery and Load Shunt Input Rating**

(A) 1mV – 150mV.

1.5.4 **LVD Sense Input Rating**

(A) Normal state is at 60V or less. A RTN signal indicates the contactor is open.

1.5.5 **LVD Driver Output Rating**

(A) Mono-stable, normal state is 60V or less at 1A continuous rating. Normally closed contactors are used for mono-stable option.

(B) Bi-Stable, normal state less than 60V and 2A at 500ms – 1000ms pulse rating.

1.6 IB2 (Controller Interface Board) Ratings (List 61, 62, 63)

1.6.1 **Digital Input Ratings**

(A) Maximum Voltage Rating: 60V DC.

(B) Active High: > 19V DC.

(C) Active Low: < 1V DC.

1.6.2 **Relay Ratings**

(A) 1A Steady State @ 30V DC.

(B) 3A Peak @ 30V DC.

2. RECTIFIER SPECIFICATIONS

Refer to the separate Rectifier Instruction Document (UM1R483500E).

3. CONVERTER SPECIFICATIONS

Refer to the separate Converter Instruction Document (UM1C400483500E).

MECHANICAL SPECIFICATIONS

Overall Dimensions

Module Mounting Shelf (List 1, 3, and 11)

List 1 Shown.

Notes:

1. All dimensions are in inches, unless otherwise specified.
2. Weight in LBS.
 Shelf
 Net: 17
 Shipping: 18
 Rectifier Module
 Net: 7
 Shipping : 8
3. Finish:
 Shelf and Rectifier Module Bodies:
 Bright Zinc Plating (M500-53)
 Rectifier Module Face Plates:
 Textured Gray (M500-147)
4. Mounting angles may be positioned from flush front mounting to 6-inch front projection mounting, in 1-inch increments.

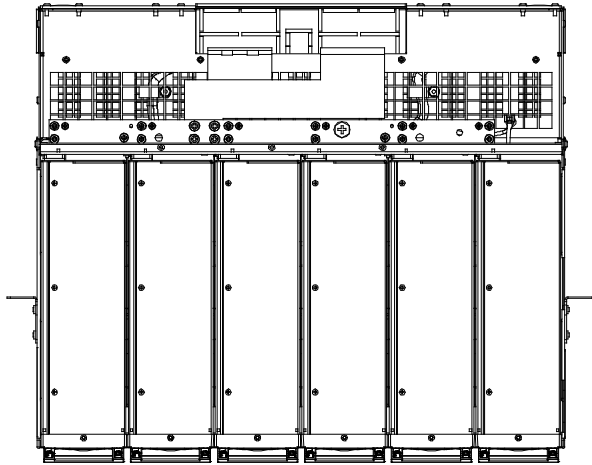

Top View

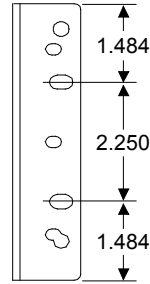

Mounting Angle Detail

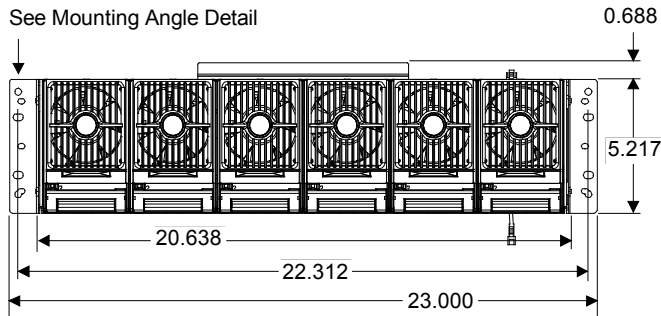

Front View

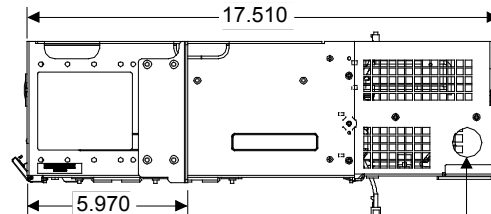

Right Side View

Hole for 3/4" Conduit Filling (AC Input)

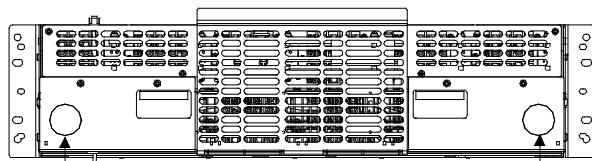

Rear View

Hole for 3/4" Conduit Filling (AC Input)

Hole for 3/4" Conduit Filling (AC Input)

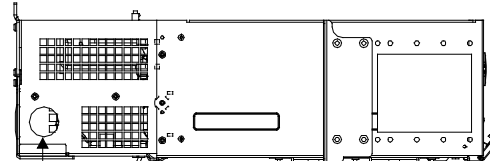

Left Side View

Hole for 3/4" Conduit Filling (AC Input)

Figure 12

[Home](#)

Module Mounting Shelf (List 22, 31, 32, 33, 41, and 42)

List 31 Shown.

Notes:

1. All dimensions are in inches, unless otherwise specified.
2. Weight in LBS.
 Shelf
 Net: 17
 Shipping: 18
 Rectifier/Converter Module
 Net: 7
 Shipping : 8
3. Finish:
 Shelf and Module Bodies:
 Bright Zinc Plating
 Module Face Plates:
 Textured Gray
4. Mounting angles are positioned for a fixed 9-inch front projection mounting.

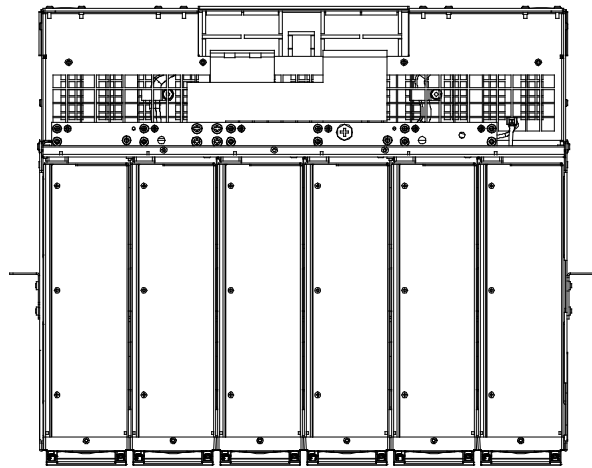

Top View

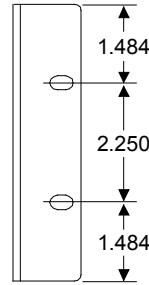

Mounting Angle Detail

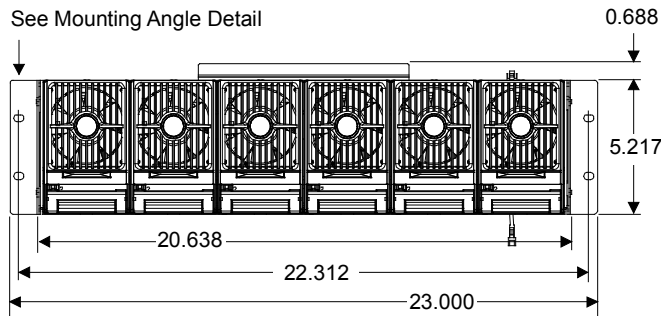

Front View

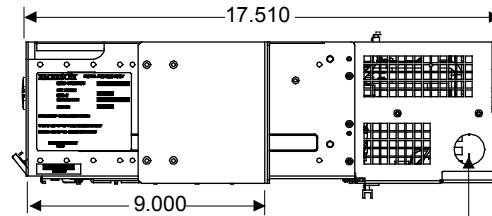

Right Side View

Hole for 3/4"
 Conduit Filling
 (Input)



Hole for 3/4"
 Conduit Filling
 (Input)

Rear View

Hole for 3/4"
 Conduit Filling
 (Input)

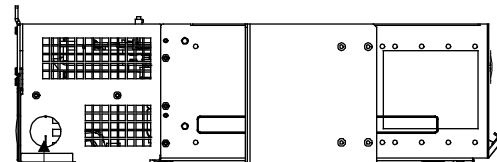

Hole for 3/4"
 Conduit Filling
 (Input)

Left Side View

Figure 13

Module Mounting Shelf (List 21 and List 40)

List 21 Shown.

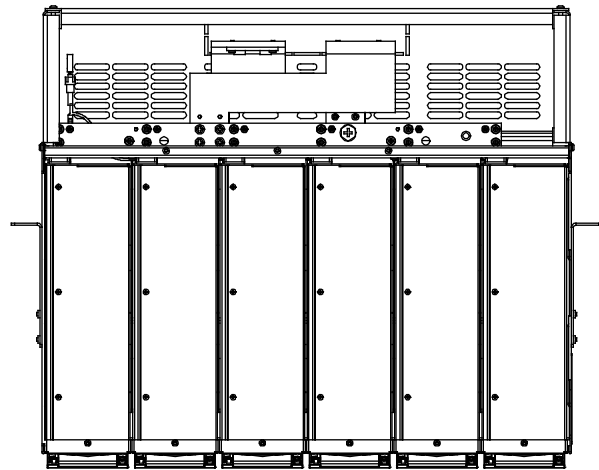

Top View

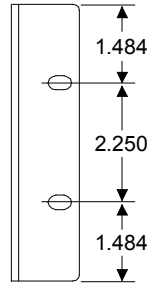

Mounting Angle Detail

Notes:

1. All dimensions are in inches, unless otherwise specified.
2. Weight in LBS.
 Shelf
 Net: 17
 Shipping: 18
 Rectifier/Converter Module
 Net: 7
 Shipping : 8
3. Finish:
 Shelf and Module Bodies:
 Bright Zinc Plating
 Module Face Plates:
 Textured Gray
4. Mounting angles are positioned for a fixed 9-inch front projection mounting.

See Mounting Angle Detail

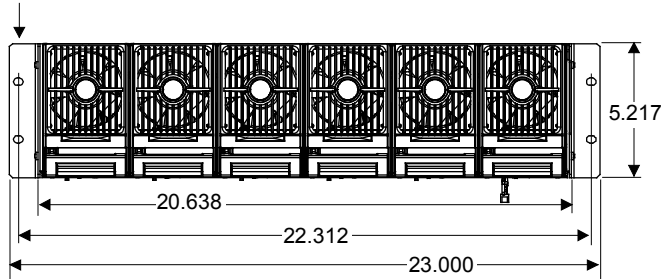

Front View

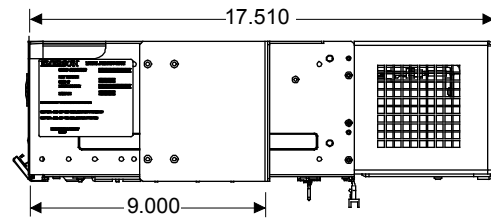

Right Side View

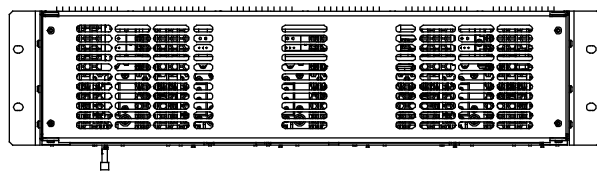

Rear View

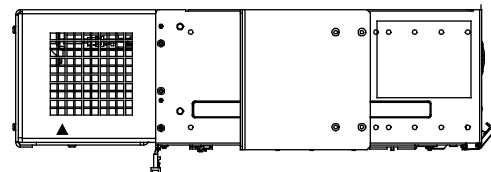

Left Side View

Figure 14

[Home](#)

Module Mounting Shelf (61, 62, and 63)

List 61 Shown.

Notes:

1. All dimensions are in inches, unless otherwise specified.
2. Weight in LBS.
 Shelf
 Net: 24
 Shipping: 25
 Rectifier Module
 Net: 7
 Shipping: 8
 NCU Controller
 Net: 2.2
 Shipping: 3.2
3. Finish:
 Shelf and Rectifier Module Bodies:
 Bright Zinc Plating
 Rectifier Module Face Plates:
 Textured Gray
4. Mounting angles are positioned for a fixed 6-inch front projection mounting.

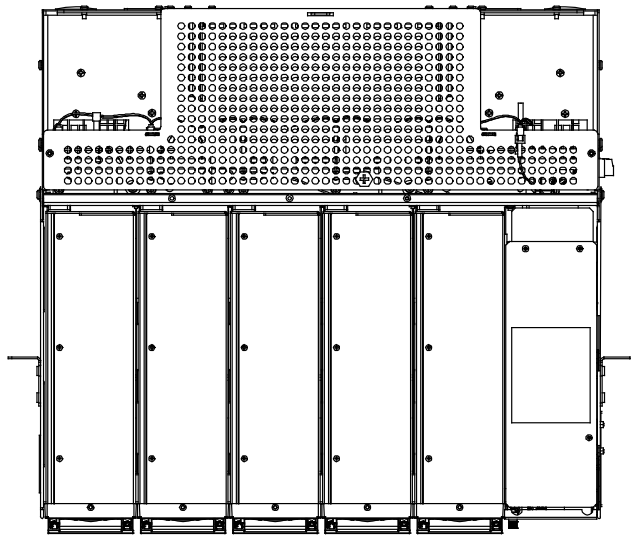

Top View

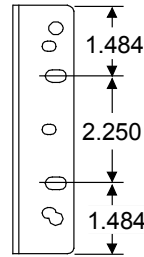

Mounting Angle Detail

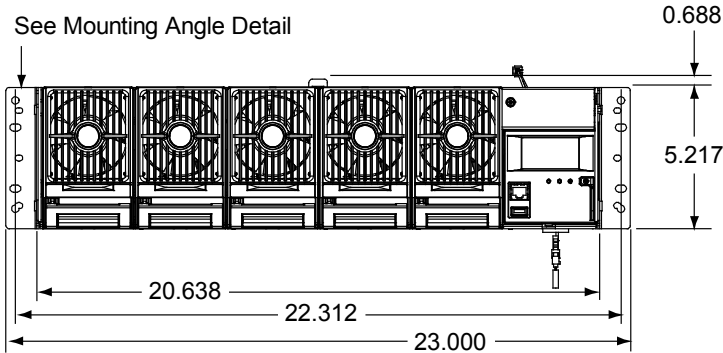

Front View

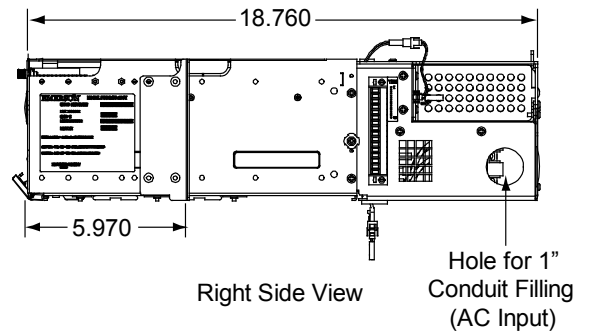

Right Side View

Hole for 1" Conduit Filling (AC Input)

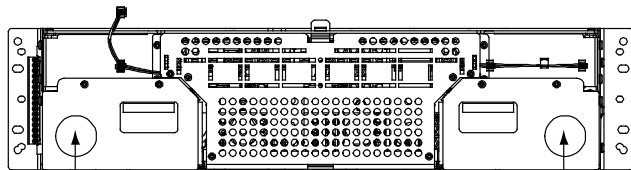

Rear View

Hole for 1" Conduit Filling (AC Input)

Hole for 1" Conduit Filling (AC Input)

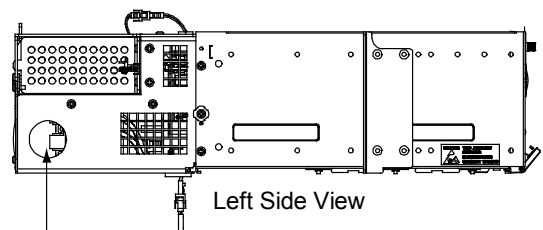

Left Side View

Hole for 1" Conduit Filling (AC Input)

Figure 15

Module Mounting Shelf (List 51, 52, and 53)

List 51 Shown.

Notes:

1. All dimensions are in inches, unless otherwise specified.
2. Weight in LBS.
 Shelf
 Net: 21
 Shipping: 22
 Rectifier Module
 Net: 7
 Shipping: 8
3. Finish:
 Shelf and Rectifier Module Bodies:
 Bright Zinc Plating
 Rectifier Module Face Plates:
 Textured Gray
4. Mounting angles are positioned for a fixed 6-inch front projection mounting.

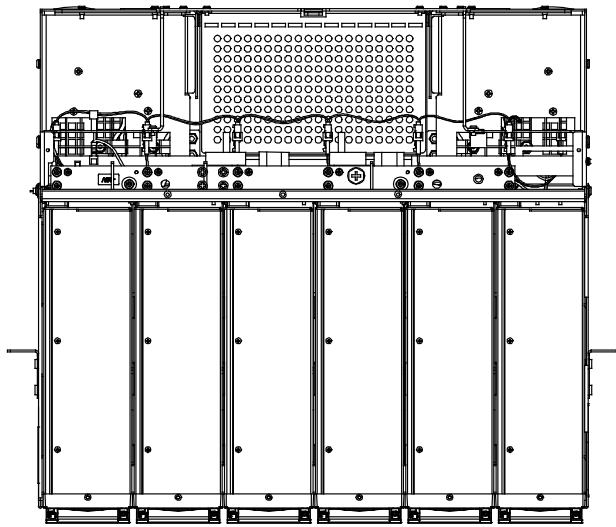

Top View

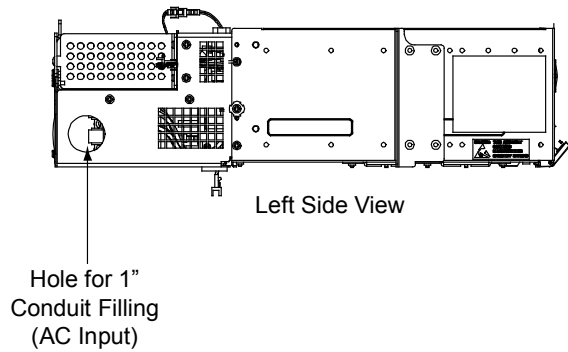
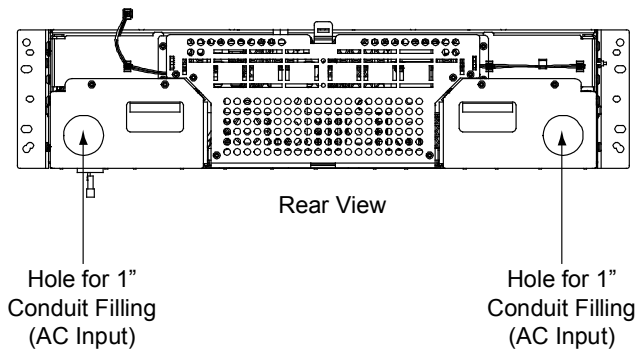
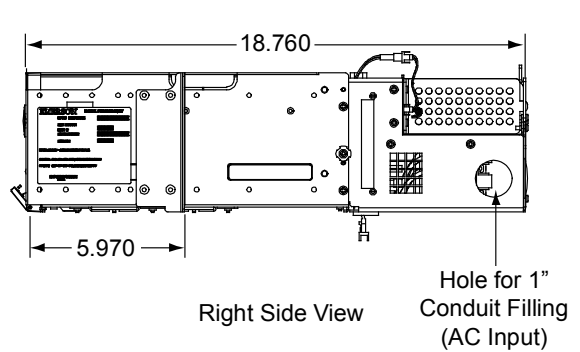
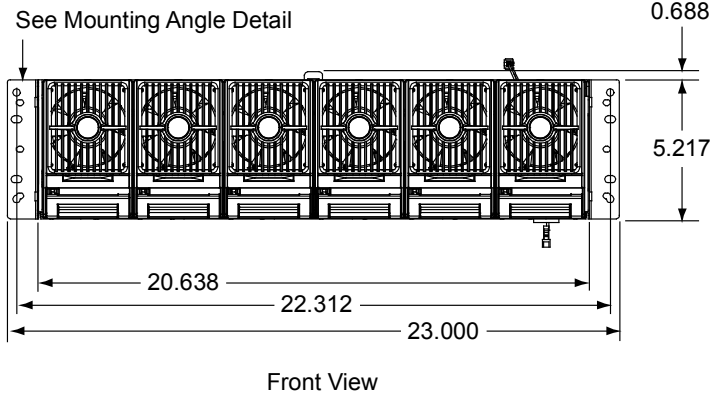
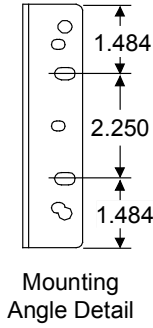

Figure 16

[Home](#)

RELATED DOCUMENTATION

Spec. No. 588705000 Module Mounting Shelf

Schematic Diagram:	SD588705000
Wiring Diagram:	T588705000

Rectifiers (1R483200, 1R483200E, 1R483500E)

Rectifier User Instructions:	UM1R483500E
------------------------------	-------------

Converters (1C400483500E)

Converter User Instructions:	UM1C400483500E
------------------------------	----------------

Spec. No. 582126000 NetSure Power System

System Application Guide:	SAG582126000
System Installation Instructions:	Section 5974
System User Instructions:	Section 5975
Color MCA Menu Tree:	Section 6022

Spec. No. 582126100 NetSure Power System

System Application Guide:	SAG582126100
System Installation Instructions:	Section 6027
System User Instructions:	Section 6028
Color MCA Menu Tree:	Section 5886

Spec. No. 582127000 NetSure Power System

System Application Guide:	SAG582127000
System Installation Instructions:	IM582127000
System User Instructions:	UM582127000
NCU Controller Instructions:	UM1M830BNA

Spec. No. 582127100 NetSure Power System

System Application Guide:	SAG582127100
System Installation and User Instructions:	UM582127100
NCU Controller Instructions:	UM1M830BNA

[Home](#)

REVISION RECORD

Issue	Change Number (ECO)	Description of Change	Date	Approved
AA	LLP205300	New	05/17/2006	John Jasko
AB	LLP207736	Miscellaneous updates per marketing.	01/11/2007	John Jasko
AC	LLP207874	AC input terminal block changed. Wire size capacity updated.	05/04/2007	John Jasko
AD	LLP208864	Revised aisle space clearance requirements in Specifications section. Corrected heat dissipation data in Para. 1.2.4 and 1.2.5.	07/30/2007	J. Kirkpatrick
AE	LLP210447	Added List 3. Corrected input data. Removed input data for multiple rectifier modules.	05/16/2008	J. Kirkpatrick
AF	LLP211072	List 11 (Shelf with AC Line Cords) added.	07/23/2008	John Jasko
AG	LLP213309	1R483200e Rectifier Module added as option.	01/20/2010	Shanon Ravacio
AH	LLP213967	Physical Dimension labeling updated.	05/06/2010	Shanon Ravacio
AJ	LLP214969	Added 1R483500e rectifier to the existing power system of 582126000. Added and updated charts for rectifier specifications.	01/04/2011	Khristebelle Ilagan
AK	LLP215678	Correct wrong content of GBB rectifier fan replacement PNs.	06/13/2011	Khristebelle Ilagan
AL	LLP215944	Adding compatibility information for 1R483500e rectifiers in systems with older software. Removing rectifier module specs. from this document and referencing the separate rectifier document.	08/11/2011	John Jasko
AM	LLP216539	Lists 21, 22, 31, and 32 added. Shelf is now used with systems having the ACU+ Controller, document revised to talk about the controller in generic terms.	04/03/2012	John Jasko
AN	LLP218430	Lists 51, 52, 53, 61, 62, and 63 added.	05/07/2013	John Jasko
AP	LLP218889	Lists 40, 41, and 42 (C400/48-3500e) added.	09/12/2013	John Jasko
AQ	LLP220488	Updating DC input voltage range for converter 1C400483500e and 588705000 using it.	06/02/2014	John Jasko
R	LLP222051	Added a List option that will allow for 277v AC input.	09/03/2015	Mitch Emata
S	LLP223817	Rebranded Vertiv.	04/25/2017	John Jasko
T	LLP224154	Updates for program PWR00980N.	06/23/2017	John Jasko
U	LLP225149	Updates for program RRM105960S (replacing ACU+ with NCU).	08/06/2018	John Jasko Mike Smith Aug 16, 2018 John Jasko Aug 20, 2018

VertivCo.com | Vertiv Headquarters, 1050 Dearborn Drive, Columbus, OH, 43085, USA

© 2018 Vertiv Co. All rights reserved. Vertiv and the Vertiv logo are trademarks or registered trademarks of Vertiv Co. All other names and logos referred to are trade names, trademarks or registered trademarks of their respective owners. While every precaution has been taken to ensure accuracy and completeness of this document, Vertiv Group Corporation assumes no responsibility and disclaims all liability for damages resulting from use of this information or for any errors or omissions. Specifications are subject to change without notice.

This document may contain confidential and/or proprietary information of Vertiv Group Corporation, and its receipt or possession does not convey any right to reproduce, disclose its contents, or to manufacture or sell anything that it may describe. Reproduction, disclosure, or use without specific authorization from Vertiv Group Corporation is strictly prohibited.

