

# LIEBERT® LIQUI-TECT™ 410 POINT LEAK DETECTION SENSOR

## Product Specification/Installation Guide



The Liebert® Liqui-Tect™ 410 (LT410) provides single-point detection of leaks. The point-detection sensor has two gold-plated sensing probes to prevent corrosion and to provide accurate readings. The LT410 constantly monitors for leaks, internal faults, and power failures and warns of any abnormal conditions. Mounting brackets allow for sensor height adjustment and leveling.

The LT410 is the ideal solution for sensing leaks under a raised computer floor or air conditioning drip pans. Two independent outputs provide added flexibility with the capacity to signal both a local alarm panel, Liebert cooling unit and a remote building management system or external equipment, such as motorized water shutoff valves.

### LT410 APPLICATIONS

The LT410 is ideally suited for:

- Glycol and chilled water cooling,
- Humidification supply water piping,
- Condensate pumps and drains,
- Unit and ceiling auxiliary drip pans,
- Overhead piping troughs.

### LOCATIONS/PLACEMENT

The LT410 is an excellent choice for:

- Large scale network control centers,
- Data centers,
- Server rooms and closets,
- Unattended, remote shelters,
- Mechanical equipment rooms,
- Sensitive areas with overhead piping,
- Industrial process control rooms.

### COMPONENTS OF THE LIQUI-TECT™ 410 MODULE

The LT410 consists of a metal enclosure with a hinged top door that provides access to the internal wiring termination. It includes side access through a box connector for installation of the power and contact wiring. The mounting brackets attach to the enclosure with adjustable slots to allow custom setting of the height of the sensing probes.

## DIMENSIONS - TOP, FRONT AND SIDE

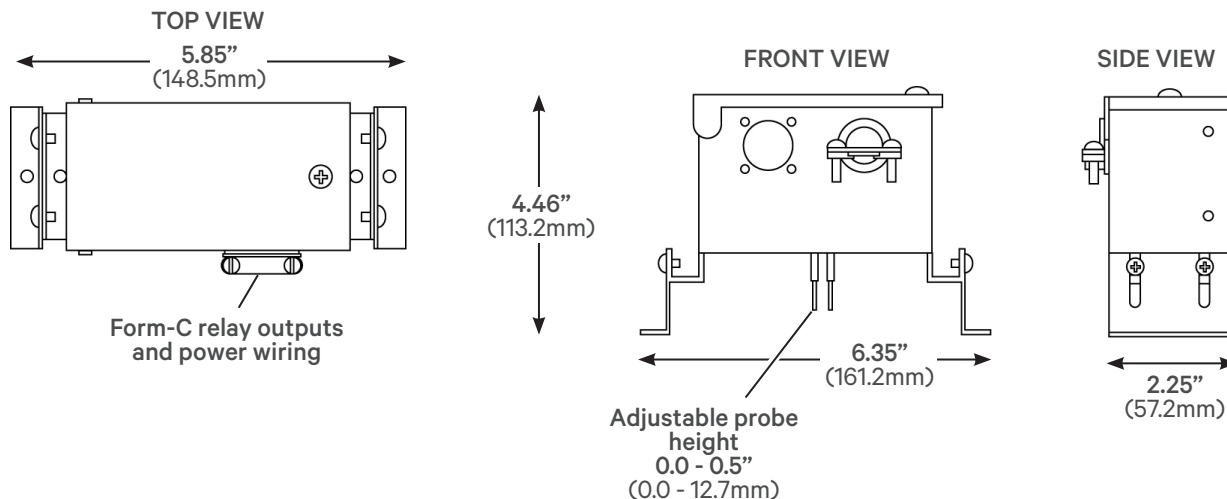

## SPECIFICATIONS

Power Requirements	24 VAC 100 mA, 50/60 Hz, 3 VA (max.)
Dimensions, W x D x H	6.35 in. x 2.25 in. x 4.46 in. (161.2 mm x 57.2 mm x 113.2 mm)
Weight (assembled)	2.0 lb. (0.9 kg)
Metal Enclosure	NEMA 1, IP 30

## ENVIRONMENTAL CONDITIONS

Operating Temperature	50°F to 104°F (10°C to 40°C)
Operating Humidity	10% to 95% relative humidity (non-condensing)
Operating Altitude	0 to 10,000 ft. (0 to 3,048 m)
Output Relay Contact Rating	2 Form-C; 3 A rating at 24 VAC

## AGENCY LISTINGS

UL	UL916
C-UL	C22.2, No. 205-M1983
CE	Yes
FCC Compliance	47 CFR, Part 15

## PLACEMENT ON SUBFLOOR UNDER COOLING SUPPORT EQUIPMENT

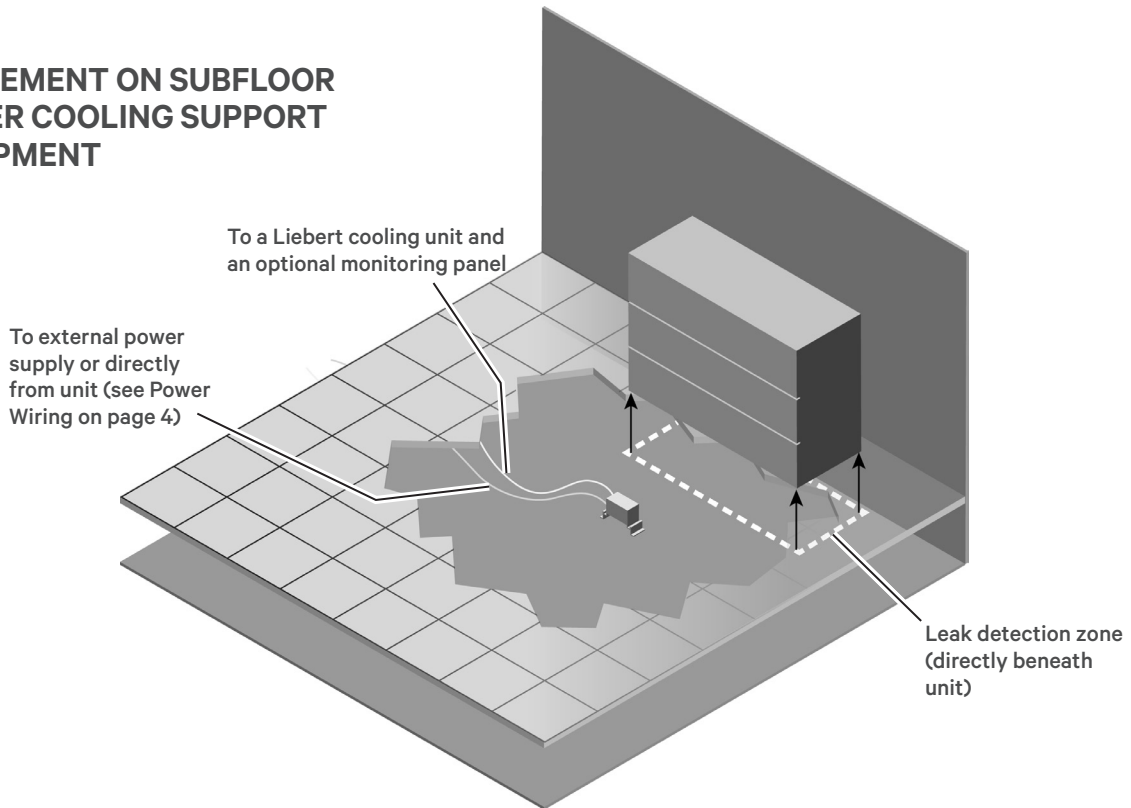

## WIRING INTERCONNECTIONS

Circuits are shown in powered, non-alarm state.

**NOTE:** All power and alarm connections must be Class 2 circuits.

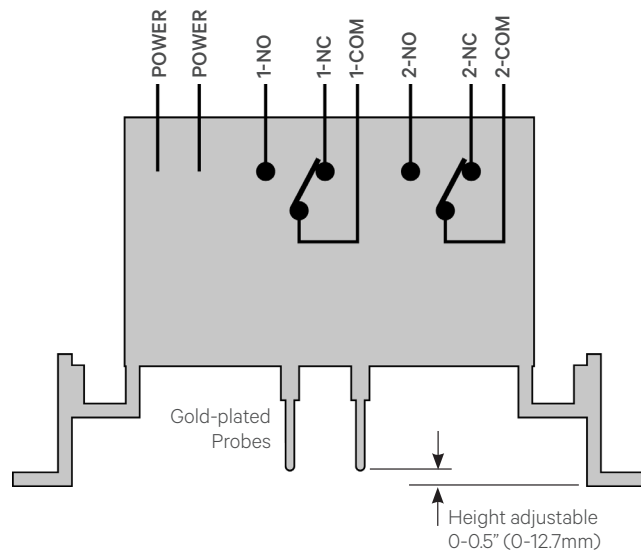

Red Wires	Orange Wires	Yellow Wires
24 V, AC/DC @ 0.10A, 50-60 Hz, DC Class 2 Circuit Only	Alarm Contact Rating 24 VAC @ 3A Class 2 Circuit Only	Alarm Contact Rating 24 VAC @ 3A Class 2 Circuit Only

## POWER WIRING

The LT410 is rated for 24 VAC, 50/60 Hz, and 0.10 A.

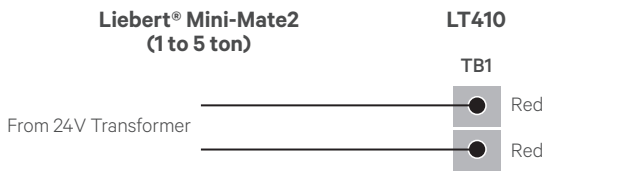
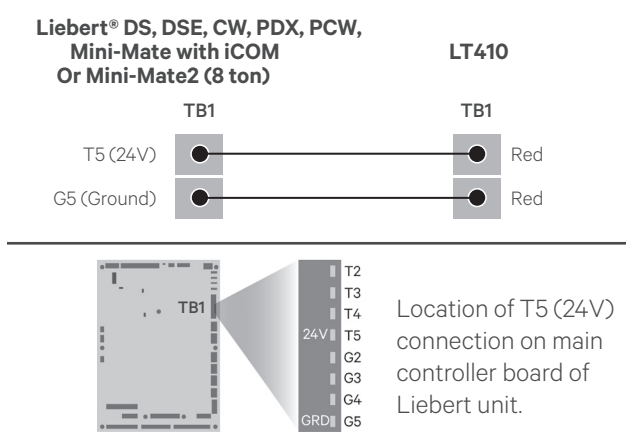

\* Requires external transformer (there are no designated terminal connections on the unit)

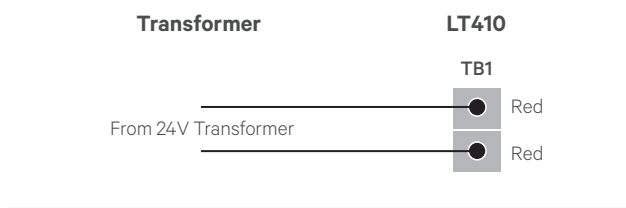
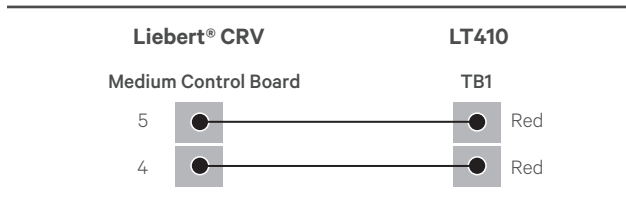

## WIRING TO AUXILIARY ALARM PANELS

The LT410 has two Form-C dry contact alarm output contacts: one orange wire and two yellow wires. Each contact is rated for 24 VAC at 3 amp.

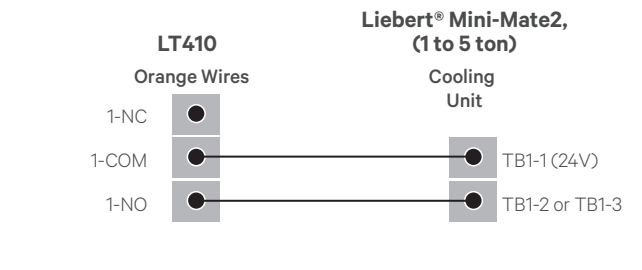
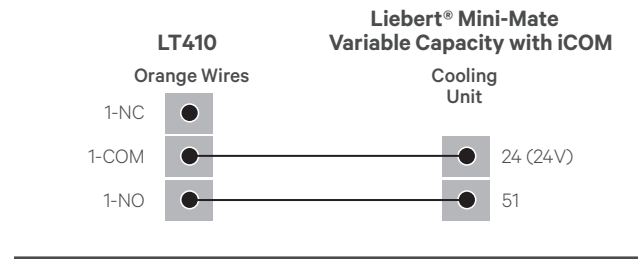
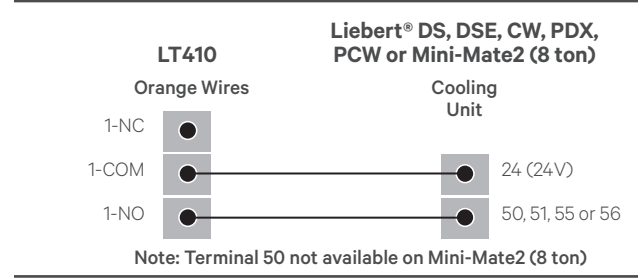

NOTE: In Liebert® iCOM™, use the Service Options menu to add that the Liqui-Tect™ is installed.

